

V.21
V.21
V.21

ADINOR

SISTEMAS DE PUERTA COLGANTE PARA ARMARIO

CLOSET HANGING SYSTEMS

SISTEMA TORINO 4
TORINO SYSTEM

SISTEMA MUNICH BZ 28
MUNICH BZ SYSTEM



TORINO











CONCEPTO FUNCIONAL

De gran versatilidad, permite fabricar armarios de grandes dimensiones mediante un herraje que puede soportar hasta 80 kg. por puerta y que permanece oculto tras las puertas.

Posibilita la fabricación de puerta de madera con un espesor máximo de 30 mm.

Incorpora perfilera de aluminio:

- Para tablero de 19 mm.
- Para tablero de 10-11 mm.
- Para vidrio 4-5 mm.

Con las que podemos realizar puertas completas de vidrio o combinaciones de vidrio-madera.

SUMMARY

These aluminum fittings make possible to manufacture large size closets, as they resist up to 80 Kg each door and keep the fitting hidden behind the doors.

It is possible yo manufacture 30mm thickness board.

The system incorporates aluminium profile:

- For 19 mm. thickness panel.
- For 10-11 mm. thickness panel.
- For 4-5 mm. glass panel.

With those aluminium profiles you can manufacture glass doors or combine glass and wood.

TORINO

ADINOR

6m. Condiciones especiales de envío
6m. Special shipping conditions

GUIAS SUPERIORES-INFERIORES 18-30mm. 18-30mm. THICKNESS BOARD UPPER-LOWER RAILS

GS28-30mm.

GUÍA REFORZADA SUPERIOR 28-30mm.

28-30mm. REINFORCED UPPER RAIL

Espesor tablero 28-30mm. Para perfilera aluminio 10-11mm

10-11mm. Aluminium profile frame. 28-30mm. Thickness board.

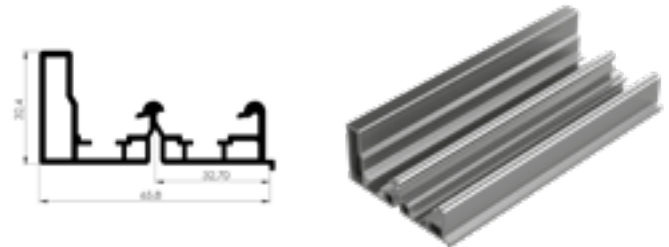

ACABADOS	FINISHINGS	6 m.
ANODIZADOS	ANODIZED	REF.
Plata Mate	Natural Anodized	-
Natural	Natural	817.A.N

GS25mm.

GUÍA SUPERIOR 25mm.

25mm. UPPER RAIL

Espesor tablero 25mm. Para perfilera aluminio 19 mm

19mm. Aluminium profile frame 25mm. Thickness board.

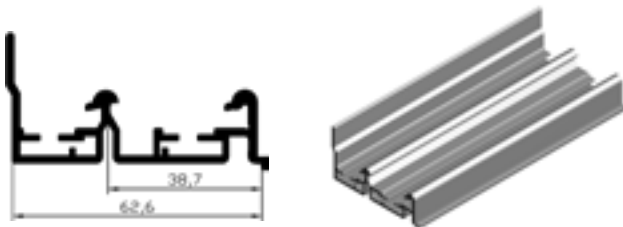

ACABADOS	FINISHINGS	6 m.
ANODIZADOS	ANODIZED	REF.
Plata Mate	Natural Anodized	-
Natural	Natural	813.A.N

GS22mm.

GUÍA SUPERIOR 22mm.

22mm. UPPER RAIL

Espesor tablero 22mm. Para perfilera aluminio 16 mm

16mm. Aluminium profile frame 22mm. Thickness board.

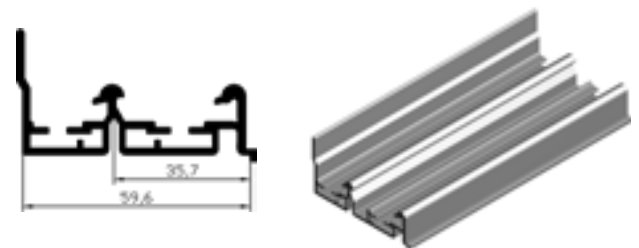

ACABADOS	FINISHINGS	6 m.
ANODIZADOS	ANODIZED	REF.
Plata Mate	Natural Anodized	-
Natural	Natural	814.A.N

GS28-30mm.

GUÍA SUPERIOR 28-30mm.

28-30mm. UPPER RAIL

Esesor tablero 28-30mm. Para perifería aluminio 10-11mm

10-11mm. Aluminium profile frame. 28-30mm. Thickness board.

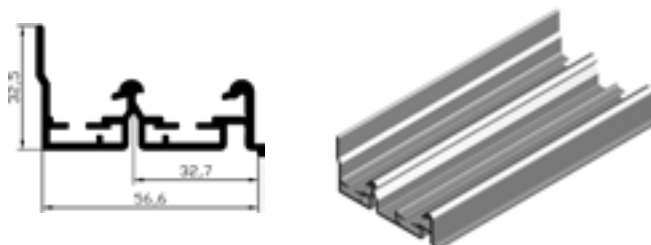

ACABADOS	FINISHINGS	6 m.
ANODIZADOS	ANODIZED	REF.
Plata Mate	Natural Anodized	-
Natural	Natural	812.A.N

GS18-19mm.

GUÍA SUPERIOR 18-19mm.

18-19 mm. UPPER RAIL

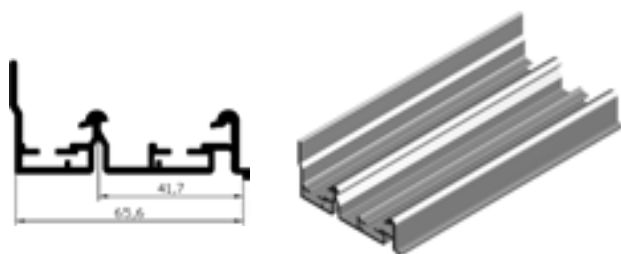

ACABADOS	FINISHINGS	6 m.
ANODIZADOS	ANODIZED	REF.
Plata Mate	Natural Anodized	-
Natural	Natural	815.A.N

GI18-30mm.

GUÍA INFERIOR 18-30mm.

LOWER RAIL FOR 18-30mm. BOARD

Para todos los espesores. All thickness board

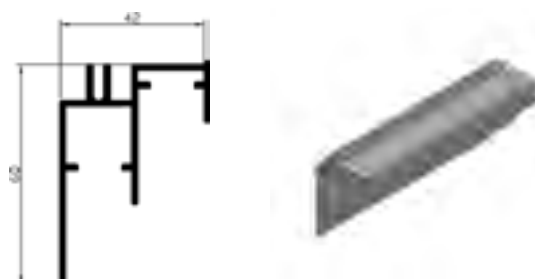

ACABADOS	FINISHINGS	6 m.
ANODIZADOS	ANODIZED	REF.
Plata Mate	Natural Anodized	-
Natural	Natural	816.A.N

TORINO

KIT GUÍAS TRACK SET

ADINOR

6m. Condiciones especiales de envío
6m. Special shipping conditions

KIT GUÍA REFORZADA 28-30mm.

KIT GUÍAS REFORZADO TABLERO 28-30 mm.

28-30mm. BOARD TRACKS KIT

Para perfilera aluminio 10-11mm
10-11mm. Aluminium profile frame

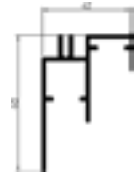
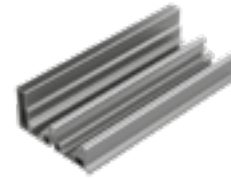

ACABADOS	FINISHINGS	2 m.	3 m.	4 m.	6 m.
ANODIZADOS	ANODIZED	REF.	REF.	REF.	REF.
Plata Mate	Natural Anodized	-	-	-	-
Natural	Natural	817KIT2M	817KIT3M	817KIT4M	817KIT6M

KIT GUÍA 25mm.

KIT GUÍAS TABLERO 25mm.

25mm. BOARD TRACKS KIT

Para perfilera aluminio 19mm
19mm. Aluminium profile frame

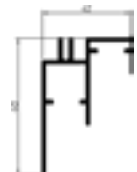

ACABADOS	FINISHINGS	2 m.	3 m.	4 m.	6 m.
ANODIZADOS	ANODIZED	REF.	REF.	REF.	REF.
Plata Mate	Natural Anodized	-	-	-	-
Natural	Natural	813KIT2M	813KIT3M	813KIT4M	813KIT6M

KIT GUÍA 28-30mm.

KIT GUÍAS TABLERO 28-30 mm.

28-30mm. BOARD TRACKS KIT

Para perfilera aluminio 10-11mm
10-11mm. Aluminium profile frame



ACABADOS	FINISHINGS	2 m.	3 m.	4 m.	6 m.
ANODIZADOS	ANODIZED	REF.	REF.	REF.	REF.
Plata Mate	Natural Anodized	-	-	-	-
Natural	Natural	812KIT2M	812KIT3M	812KIT4M	812KIT6M

KIT GUÍA 22mm.

KIT GUÍAS TABLERO 22mm.

22mm. BOARD TRACKS KIT

Para perfilera aluminio 16mm
16mm. Aluminium profile frame

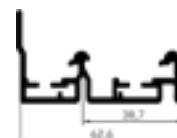

ACABADOS	FINISHINGS	2 m.	3 m.	4 m.	6 m.
ANODIZADOS	ANODIZED	REF.	REF.	REF.	REF.
Plata Mate	Natural Anodized	-	-	-	-
Natural	Natural	814KIT2M	814KIT3M	814KIT4M	814KIT6M

KIT GUÍA 18-19mm.

KIT GUÍAS TABLERO 18-19mm.

18-19mm. BOARD TRACKS KIT



ACABADOS	FINISHINGS	2 m.	3 m.	4 m.	6 m.
ANODIZADOS	ANODIZED	REF.	REF.	REF.	REF.
Plata Mate	Natural Anodized	-	-	-	-
Natural	Natural	815KIT2M	815KIT3M	815KIT4M	815KIT6M

TORINO
COMPLEMENTOS
COMPLEMENTS

ADINOR

PUERTA INTERIOR

FITTINGS SET FOR INNER DOOR



REF.
887CPINT

FILM TEXTIL AUTOADHESIVO

SELF-ADHESIVE GLASS PROTECTOR FABRIC

Rollos / Roll: **0,5 x 20m.**

REF.	Medida / Measure
1519	Rollos / Roll 0,5 x 20m
1519DB	Rollos / Roll 1 x 20m



PUERTA EXTERIOR

FITTINGS SET FOR OUTER DOOR

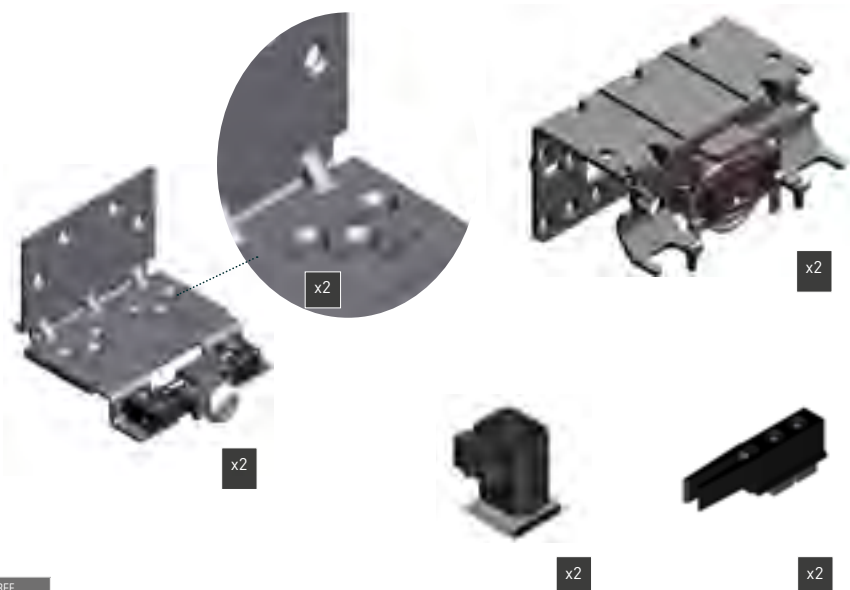

REF.
877CPEXT

ENDEREZADOR PUERTA

DOOR STRAIGHTENER



REF.
MUN750

Dos Puertas / Two Doors

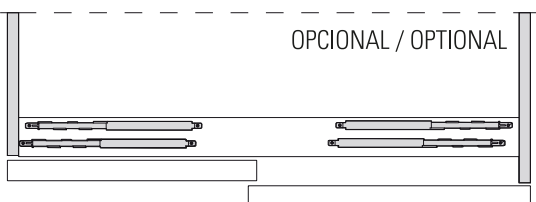

Tres Puertas / Three Doors

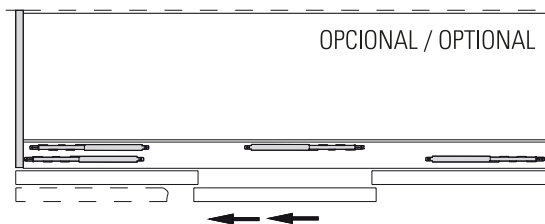

AMORTIGUADOR 25 & 40 kg.

25 & 40 kg. SOFT-CLOSING

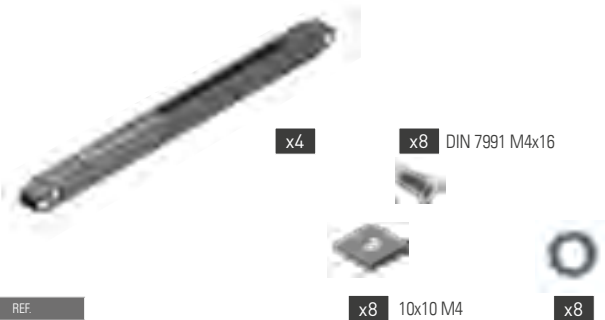

REF.
893AMORT25
893AMORT40

AMORTIGUADOR INVERTIDO 25 & 40 kg.

25 & 40 kg. SOFT-CLOSING

Especial para puertas estrechas
Special for narrow doors



REF.
894AMORTINV25
894AMORTINV40

AMORTIGUADOR 60 & 80 kg.

60 & 80 kg. SOFT-CLOSING

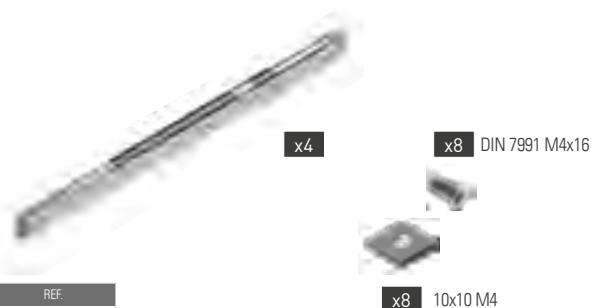

REF.
893AMORT60
893AMORT80

AMORTIGUADOR INVERTIDO 60 kg.

60 kg. SOFT-CLOSING

Especial para puertas estrechas
Special for narrow doors



REF.
894AMORTINV60

PERFILERIA DE ALUMINIO PARA TABLERO 16mm.

16mm. THICKNESS BOARD HANDLE PROFILES

6m. Condiciones especiales de envío
6m. Special shipping conditions

T. I. 16mm.
TIRADOR INT. 16mm.
19mm. INNER HANDLE
PROFILE

Esesor tablero 16mm
16mm. Thickness board

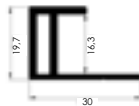
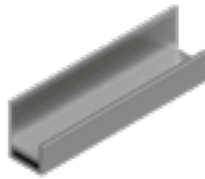

Longitud / Length: 5,4 m.

REF.

828.A.PM

-

T. EX. 16mm.
TIRADOR EXT. 16mm.
19mm. OUTER HANDLE
PROFILE

Esesor tablero 16mm
16mm. Thickness board

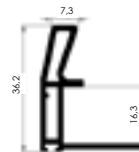
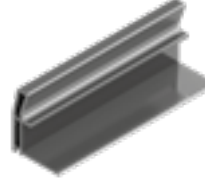

Longitud / Length: 5,4 m.

REF.

838.A.PM

-

15x15
ÁNGULO 15x15
ANGLE PROFILE 15x15



Longitud / Length: 6 m.

REF.

150.A.PM

-

ACABADOS

FINISHINGS

ANODIZADOS

ANODIZED

Plata Mate

Natural Anodized

Natural

Natural

U16mm.
U PARA TABLERO 16mm.
16mm. U PROFILE BOARD



Longitud / Length : 6 m.

REF.

152.A.PM

-

H16mm.
H PARA TABLERO 16mm.
16mm. H PROFILE BOARD



Longitud / Length : 6 m.

REF.

1525.A.PM

-

ACABADOS

FINISHINGS

ANODIZADOS

ANODIZED

Plata Mate

Natural Anodized

Natural

Natural

KIT PUERTAS 16mm.

16mm. SLIDING DOOR KIT

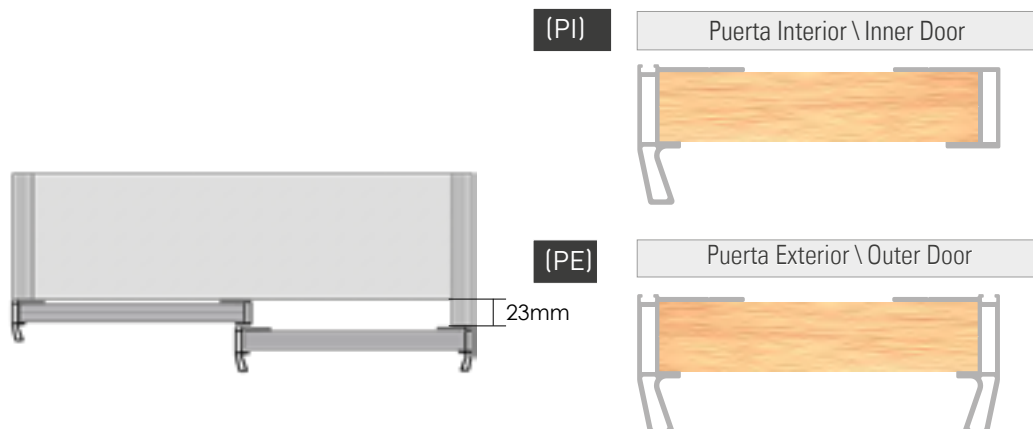

KIT PI 16mm.

KIT PUERTA INTERIOR 16mm.

16mm. INNER DOOR SET

Espesor tablero 16mm
16mm. Thickness board

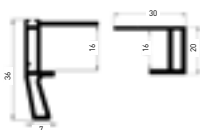

Contenido Kit

- 1x2,7m. Tirador torino interior
- 1x2,7m. Tirador torino exterior
- 2x2,7m. Cepillo 4x6

Kit Elements

- 1x2,7m. Torino Inner handle profile
- 1x2,7m. Torino Outer handle profile
- 2x2,7m. 4x6 Brush

REF.

828KPI.APM

KIT PE 16mm.

KIT PUERTA EXTERIOR 16mm

16mm. OUTER DOOR SET

Espesor tablero 16mm
16mm. Thickness board

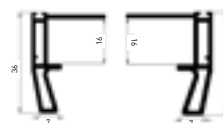

Contenido Kit

- 2x2,7m. Tirador Torino exterior
- 2x2,7m. Cepillo 4x6

Kit Elements

- 2x2,7m. Torino Inner handle profile
- 2x2,7m. 4x6 Brush

REF.

838KPE.APM

ACABADOS

ANODIZADOS

Plata Mate

FINISHINGS

ANODIZED

Natural Anodized

PERFILERIA DE ALUMINIO PARA TABLERO 18-19mm.

18-19mm. THICKNESS BOARD HANDLE PROFILES

6m. Condiciones especiales de envío
6m. Special shipping conditions

T.I. 19mm.

TIRADOR INT. 19mm.
19mm. INNER HANDLE
PROFILE

Esesor tablero 19mm
19mm. Thickness board



Longitud / Length: 5,4 m.

REF.

827.L.B

827.L.NM

REF.

827.A.PM

-

REF.

827.M.MR

REF.

827.C.RB

T. EX. 19mm.

TIRADOR EXT. 19mm.
19mm. OUTER HANDLE
PROFILE

Esesor tablero 19mm
19mm. Thickness board

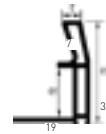
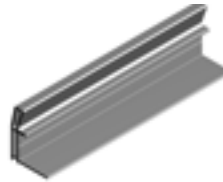

Longitud / Length: 5,4 m.

REF.

837.L.B

837.L.NM

REF.

837.A.PM

-

REF.

837.M.MR

REF.

837.C.RB

T. EX. 19mm.

TIRADOR EXT. TAPALUZ 19mm.
19mm. EXTRA OUTER
HANDLE PROFILE

Esesor tablero 19mm
19mm. Thickness board

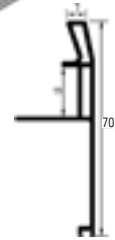
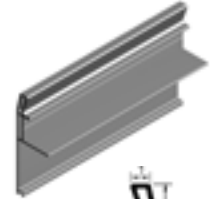

Longitud / Length: 5,4 m.

REF.

847.L.B

847.L.NM

REF.

847.A.PM

-

REF.

847.M.MR

REF.

847.C.RB

ACABADOS

FINISHINGS

LACADOS	COATED
Blanco Brillo RAL 9010	White RAL9010
Negro Mate	Mat Black
ANODIZADOS	ANODIZED
Plata Mate	Natural Anodized
Natural	Natural
MELAMINA	MELAMINE
Blanco Rebornizable	White
MADERA	NATURAL WOOD
Roble Francés	Oak

U19mm.

PERFIL U 19mm.
19mm. U PROFILE

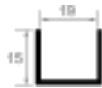

Longitud / Length: 6 m.

REF.

1522.L.B

1522.L.NM

REF.

1522.A.PM

-

REF.

1522.M.MR

REF.

1522.C.RB

H19mm.

PERFIL H 19mm.
19mm. H PROFILE



Longitud / Length: 6 m.

REF.

1580.A.PM

1580.L.NM

REF.

1580.A.PM

-

REF.

1580.M.MR

REF.

1580.C.RB

ACABADOS

FINISHINGS

LACADOS	COATED
Blanco Brillo RAL 9010	White RAL9010
Negro Mate	Mat Black
ANODIZADOS	ANODIZED
Plata Mate	Natural Anodized
Natural	Natural
MELAMINA	MELAMINE
Blanco Rebornizable	White
MADERA	NATURAL WOOD
Roble Francés	Oak

KIT PUERTAS 19mm.

19mm. SLIDING DOOR KIT



34mm

(PI)

Puerta Interior \ Inner Door



(PE)

Puerta Exterior \ Outer Door



(PET)

Puerta Exterior Tapaluz
Extra-Outer Door

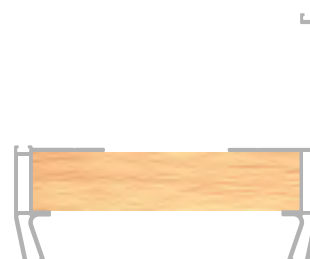

KIT PI 19mm.

KIT PUERTA INTERIOR 19mm.
19mm. INNER DOOR SET

Espesor tablero 19mm
19mm. Thickness board

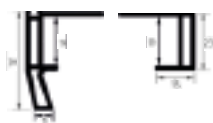

Contenido Kit

1x2,7m. Tirador torino interior
1x2,7m. Tirador torino exterior
2x2,7m. Cepillo 4x6

Kit Elements

1x2,7m. Torino Inner handle profile
1x2,7m. Torino Outer handle profile
2x2,7m. 4x6 Brush

REF.

827KPI.L.B

827KPI.L.NM

REF.

827KPI.APM

-

REF.

827KPI.M.MR

REF.

827KPI.C.RB

KIT PE 19mm.

KIT PUERTA EXTERIOR 19mm.
19mm. OUTER DOOR SET

Espesor tablero 19mm
19mm. Thickness board



Contenido Kit

2x2,7m. Tirador Torino exterior
2x2,7m. Cepillo 4x6

Kit Elements

2x2,7m. Torino Inner handle profile
2x2,7m. 4x6 Brush

REF.

837KPE.L.B

837KPE.L.NM

REF.

837KPE.APM

-

REF.

837KPE.M.MR

REF.

837KPE.C.RB

KIT PET 19mm.

KIT PUERTA EXT. CON TAPALUZ 19mm.
19mm. EXTRA-OUTER DOOR SET

Espesor tablero 19mm
19mm. Thickness board



Contenido Kit

1x2,7m. Tirador torino exterior tapaluz
1x2,7m. Tirador torino exterior
2x2,7m. Cepillo 4x6

Kit Elements

1x2,7m. Torino Extra-Outer handle profile
1x2,7m. Torino Outer handle profile
2x2,7m. 4x6 Brush

REF.

847KPET.L.B

837KPET.L.NM

REF.

847KPET.APM

-

REF.

847KPET.M.MR

REF.

847KPET.C.RB

ACABADOS	FINISHINGS
LACADOS	COATED
Blanco Brillo RAL 9010	White RAL9010
Negro Mate	Mat Black
ANODIZADOS	ANODIZED
Plata Mate	Natural Anodized
Natural	Natural
MELAMINA	MELAMINE
Blanco Rebornizable	White
MADERA	NATURAL WOOD
Roble Francés	Oak

PERFILERIA DE ALUMINIO PARA TABLERO 10-11mm

10-11mm. AND 4-5mm. GLASS THICKNESS BOARD HANDLE PROFILES

6m. Condiciones especiales de envío
6m. Special shipping conditions

T. I. 10-11mm.
TIRADOR INT. 10-11mm.
10-11mm. INNER
HANDLE PROFILE

T. EX. 10-11mm.
TIRADOR EXT. 10-11mm.
10-11mm. OUTER
HANDLE PROFILE

T. EX. 10-11mm.
TIRADOR EXT. TAPALUZ 10-11mm.
10-11mm. EXTRA OUTER
HANDLE PROFILE

FALDÓN
FALDÓN SUP.-INF.
UPPER-LOWER
CONNECTION PROFILE

Espesor tablero 10-11mm
Vidrio 4-5mm

Espesor tablero 10-11mm
Vidrio 4-5mm

Espesor tablero 10-11mm
Vidrio 4-5mm

Espesor tablero 10-11mm
Vidrio 4-5mm

10-11mm. Thickness board
4-5mm. Glass panel

10-11mm. Thickness board
4-5mm. Glass panel

10-11mm. Thickness board
4-5mm. Glass panel

10-11mm. Thickness board
4-5mm. Glass panel



ACABADOS

FINISHINGS

Longitud / Length : 5,4 m.

Longitud / Length : 5,4 m.

Longitud / Length : 5,4 m.

Longitud / Length : 4,81 m.

ANODIZADOS

ANODIZED

REF.

REF.

REF.

REF.

Plata Mate

Natural Anodized

826.A.PM

836.A.PM

846.A.PM

856.A.PM

Natural

Natural

Transparente

Transparent

TENSOR UNIÓN PERFIL VERTICAL CON HORIZONTAL

PERPENDICULAR JOINT



REF.

869TU

HERRAJE UNIÓN FALDÓN SUPERIOR - INFERIOR

ASSEMBLY NUTS AND SCREWS - ROLLER TO CONNECTION PROFILE



x12 10x10x4 M4



x14 10x10x10 M4



x14 DIN 7991 M4x12



x12 DIN 7991 M4x8

Conjunto para 1 puerta interior y 1 exterior
Set for 1 inner and 1 outer door

REF.

859KHA

KIT PUERTAS 10-11mm. Y VIDRIO 4-5mm. (con reductor)

10-11mm. AND 4-5mm. GLASS SLIDING DOOR KIT

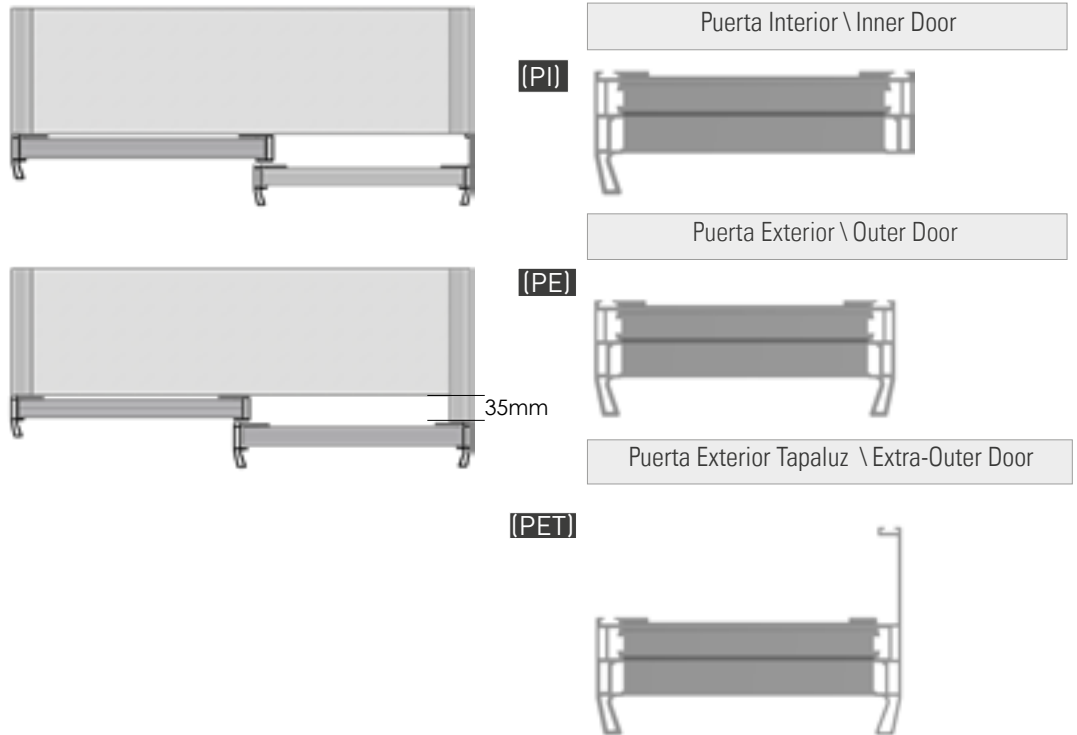

KIT PI

KIT PUERTA INTERIOR
INNER DOOR SET

Espesor tablero 10-11mm
Vidrio 4-5mm

10-11mm. Thickness board
4-5mm. Glass panel

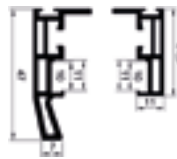

Contenido Kit

1x2,7m. Tirador torino interior
1x2,7m. Tirador torino exterior
2x2,7m. Reductor PVC vidrio 4-5mm.
2x2,7m. Cepillo 7x6

Kit Elements

1x2,7m. Torino Inner handle profile
1x2,7m. Torino Outer handle profile
2x2,7m. PVC Gasket 4-5mm. glass
2x2,7m. 7x6 Brush

REF.

825KPI.APM

KIT PE

KIT PUERTA EXTERIOR
OUTER DOOR SET

Espesor tablero 10-11mm
Vidrio 4-5mm

10-11mm. Thickness board
4-5mm. Glass panel

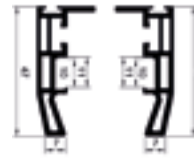

Contenido Kit

2x2,7m. Tirador Torino exterior
2x2,7m. Reductor PVC vidrio 4-5mm.
2x2,7m. Cepillo 7x6

Kit Elements

2x2,7m. Torino Inner handle profile
2x2,7m. PVC Gasket 4-5mm. glass
2x2,7m. 7x6 Brush

REF.

835KPE.APM

KIT PET

KIT PUERTA EXT. CON TAPALUZ
EXTRA-OUTER DOOR SET

Espesor tablero 10-11mm
Vidrio 4-5mm

10-11mm. Thickness board
4-5mm. Glass panel

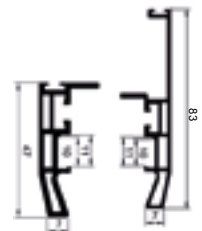

Contenido Kit

1x2,7m. Tirador torino exterior tapaluz
1x2,7m. Tirador torino exterior
2x2,7m. Reductor PVC vidrio 4-5mm.
2x2,7m. Cepillo 7x6

Kit Elements

1x2,7m. Torino Extra-Outer handle profile
1x2,7m. Torino Outer handle profile
2x2,7m. PVC Gasket 4-5mm. glass
2x2,7m. 7x6 Brush

REF.

845KPET.APM

KIT H

KIT H (2un.)
H SET (2un.)



Contenido Kit

2un.	Perfil H
4un.	Reductor PVC vidrio 4-5mm.
4un.	Tensor unión perfiles + tornillos

Kit Elements

2un.	H Profile
4un.	PVC Gasket 4-5mm. glass
4un.	Perpendicular Joint + screws

KIT TENSOR VIDRIO

KIT TENSOR VIDRIO (2un.)
STRAIGHTENER GLASS SET (2un.)



Contenido Kit

2un.	Perfil tensor vidrio
1un.	Goma reductora Tensor Vidrio
4un.	Tensor unión perfiles + tornillos

Kit Elements

2un.	Straightener profile for glass
1un.	Gasket for 4-5mm. Glass
4un.	Perpendicular Joint + screws

ACABADOS	FINISHINGS	KIT 1,2 m.	KIT 1,6 m.	KIT 1,2 m.	KIT 1,6 m.
ANODIZADOS	ANODIZED	REF.	REF.	REF.	REF.
Plata Mate	Natural Anodized	865KH.APM1.2	865KH.APM1.6	866KTV.APM1.2	866KTV.APM1.6
Natural	Natural	-	-	-	-

KIT HETTICH TOP LINE XL

KIT TENSOR MADERA

KIT TENSOR MADERA (2un.)
STRAIGHTENER WOOD SET (2un.)

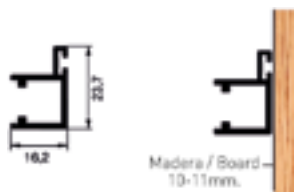

Contenido Kit

2un.	Perfil tensor madera
4un.	Tensor unión perfiles + tornillos

Kit Elements

2un.	Straightener profile for wood
4un.	Perpendicular Joint + screws

KIT FALDÓN

KIT FALDÓN SUPERIOS / INFERIOR
UPPER & LOWER CONNECTION PROFILE



Contenido Kit

2un.	Faldón superior e inferior
2un.	Reductor PVC vidrio 4-5mm.
8un.	Tensor unión perfiles + tornillos
	Tuercas y tornillos unión carros

Kit Elements

2un.	Upper and lower connection profile
2un.	PVC Gasket 4-5mm. glass
8un.	Perpendicular Joint + screws
	Screws and nuts to joint the rollers

KIT FALDÓN HT

KIT FALDÓN HT SUPERIOR E INFERIOR
HT UPPER & LOWER CONNECTION PROFILE



Contenido Kit

2un.	Faldón superior e inferior
2un.	Reductor PVC vidrio 4-5mm.
8un.	Tensor unión perfiles + tornillos

Kit Elements

2un.	Upper and lower connection profile
2un.	PVC Gasket 4-5mm. glass
8un.	Perpendicular Joint + screws

SOLO TOP LINE XL DE HETTICH
ONLY FOR HETTICH TOP LINE XL

ACABADOS	FINISHINGS	KIT 1,2 m.	KIT 1,6 m.	KIT 1,2 m.	KIT 1,6 m.	KIT 1,2 m.	KIT 1,6 m.
ANODIZADOS	ANODIZED	REF.	REF.	REF.	REF.	REF.	REF.
Plata Mate	Natural Anodized	867KTM.APM1.2	867KTM.APM1.6	855KF.APM1.2	855KF.APM1.6	855KFH.APM1.2	855KFH.APM1.6
Natural	Natural	-	-	-	-	-	-

TORINO

INSTRUCCIONES DE MONTAJE

ASSEMBLY INSTRUCTIONS

ADINOR

DESCÁRGATE LAS INSTRUCCIONES COMPLETAS EN:
www.adinor.info/instrucciones-de-montaje
(Instrucciones montaje SISTEMA TORINO)

DOWNLOAD THE COMPLETE ASSEMBLY INSTRUCTIONS
www.adinor.info/instrucciones-de-montaje
(TORINO)

MONTAJE ENDEREZADOR PUERTA

DOOR STRAIGHTENER ASSEMBLY

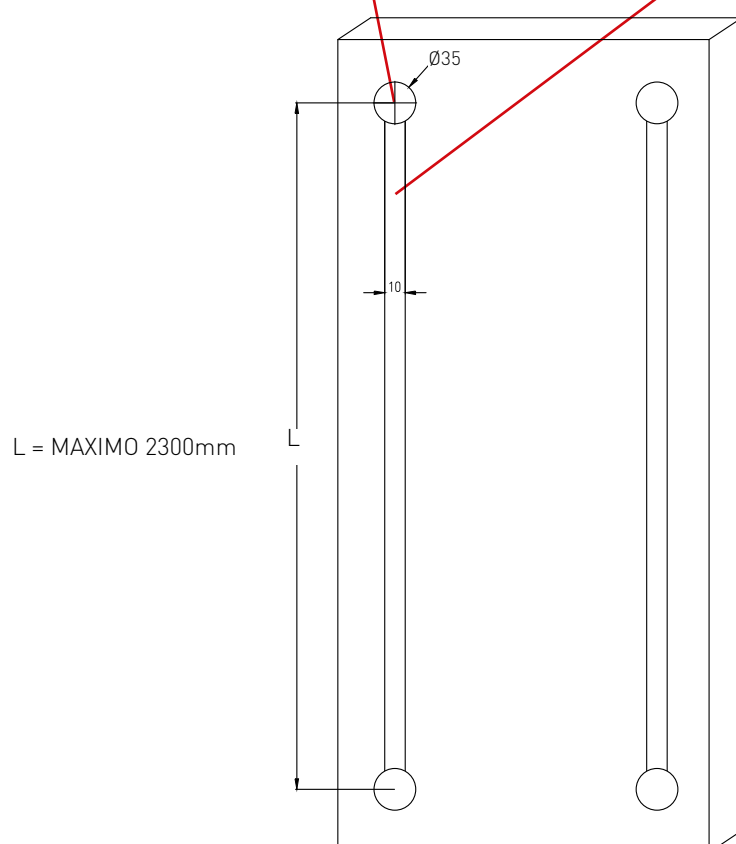
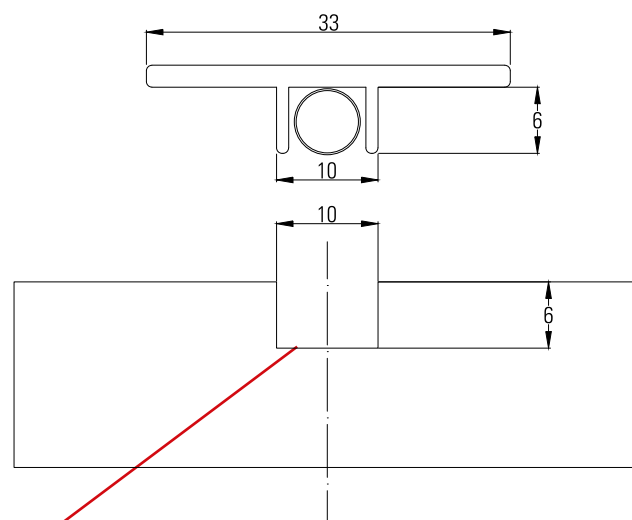
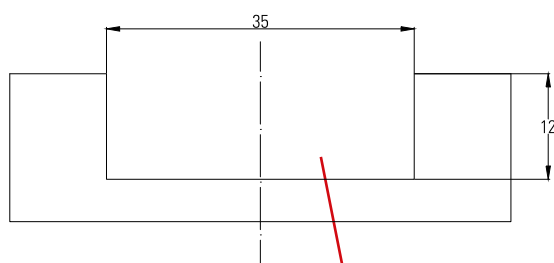

L = MAXIMO 2300mm

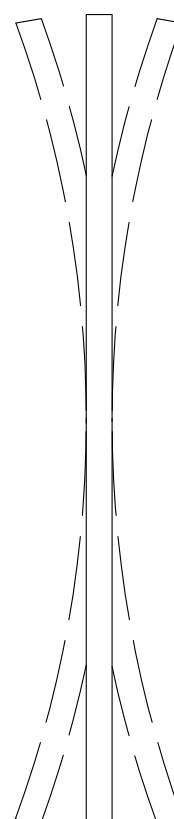

Dos Puertas / Two Doors

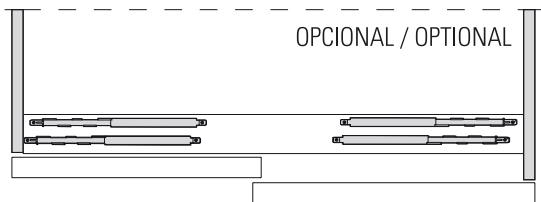

Tres Puertas / Three Doors

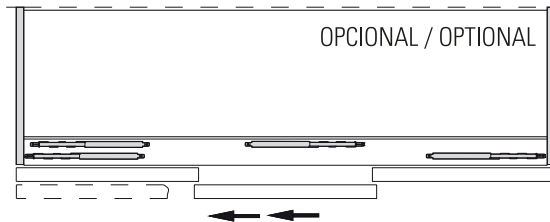

Gruaso puerta / Chip Board Thickness

18,19, 22, 25, 28, 30

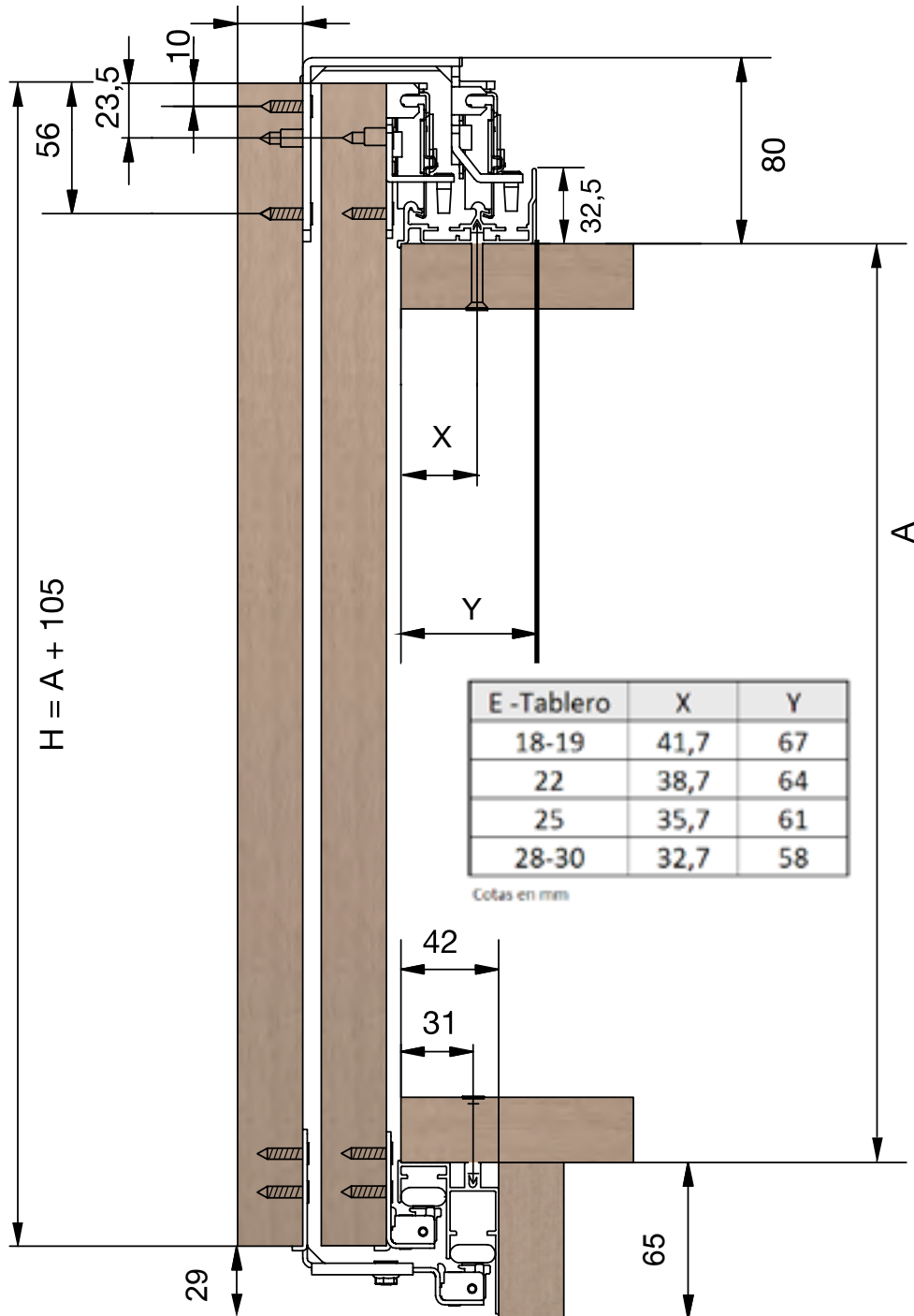

TORINO

INSTRUCCIONES DE MONTAJE

ASSEMBLY INSTRUCTIONS

ADINOR



1

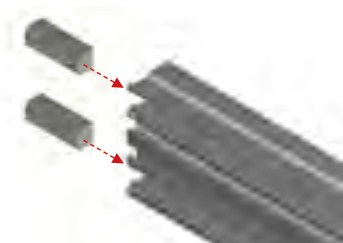

2

Enrasar con el perfil horizontal.
Perpendicular joint must not protrude out of the horizontal profile.



3

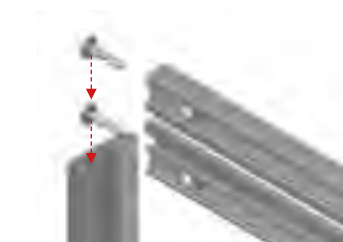

4



5

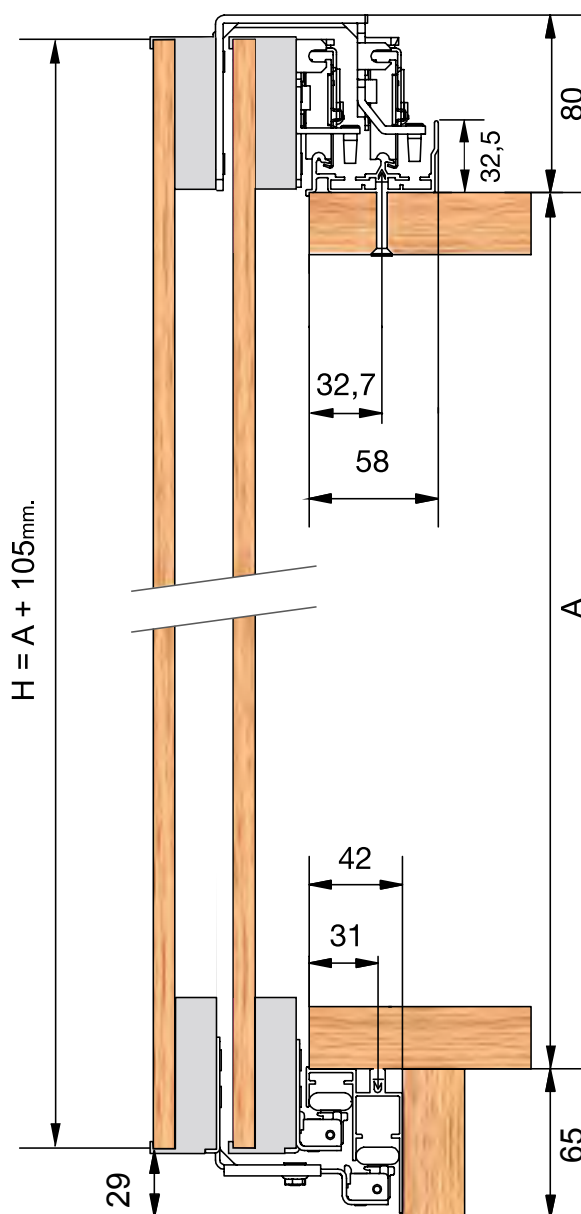
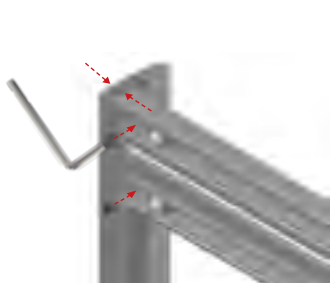

Cálculo ancho de puertas / Board width
 Armario 2 puertas / 2 doors wardrobe

$$P = \frac{L}{2} + 5mm.$$

Anchura panel Cristal
 Glass Width

P - 16mm.

Cálculo ancho de puertas / Board width
 Armario 3 puertas / 3 doors wardrobe

$$P = \frac{L}{3} + 7mm.$$

Anchura panel Madera
 Board Width

P - 14mm.

Cálculo ancho de puertas / Board width
 Armario 4 puertas / 4 doors wardrobe

$$P = \frac{L}{4} + 7mm.$$

<p>Longitud Perfil Faldón Superior / Inferior Upper and Lower Connection Torino Profile Width</p> <p>Longitud Perfil H Torino H Profile Width</p> <p>Longitud Tensor Madera / Cristal Straightener Torino Glass / Wood Profile Width</p>	<p>P - 21mm.</p>
--	------------------

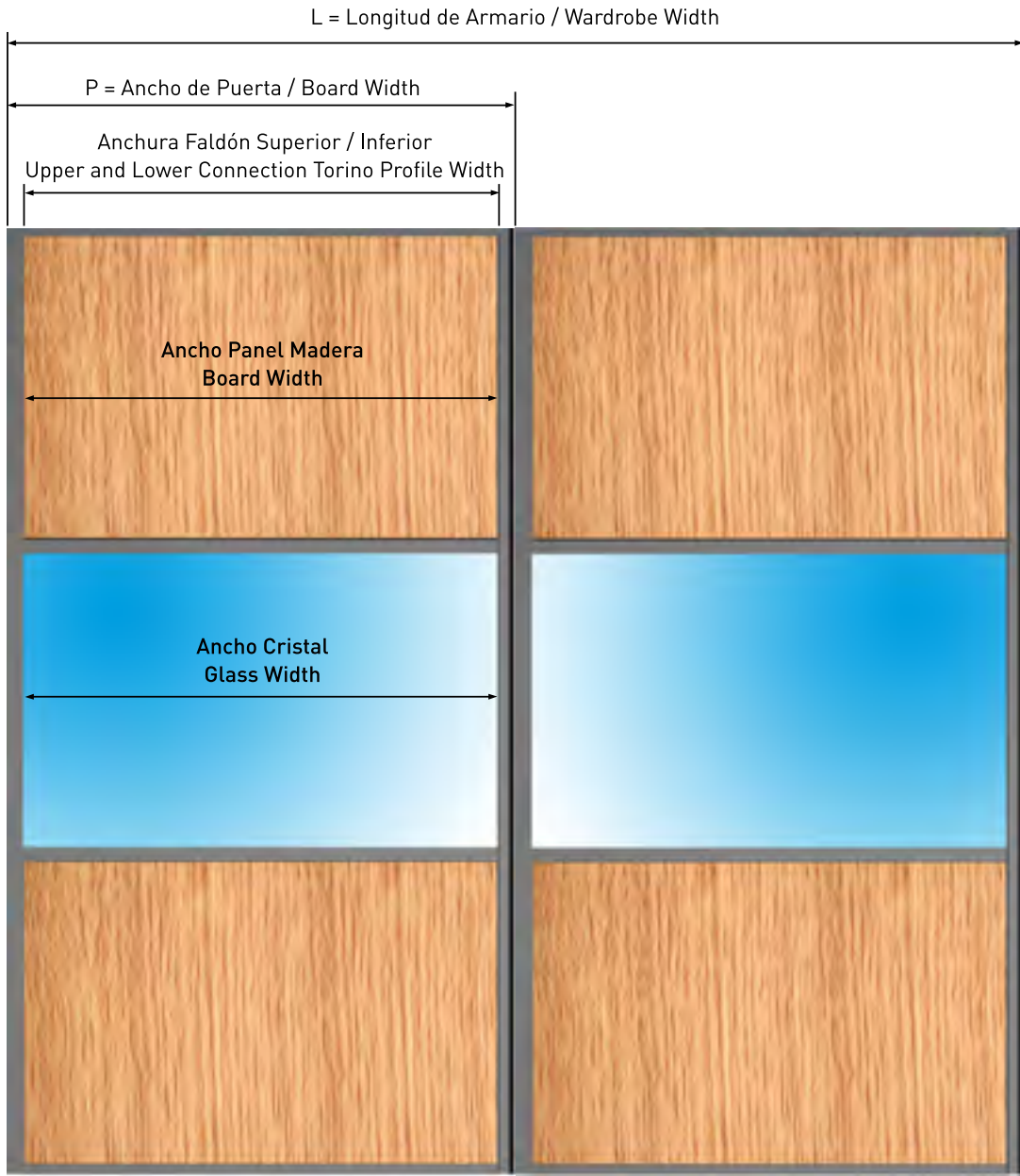

MUNICH BZ











CONCEPTO FUNCIONAL

Este tipo de construcción permite que las puertas puedan quedar alineadas en un mismo plano, creando un efecto de continuidad visual en las puertas.

Permiten fabricar frentes de armario de gran amplitud donde el herraje queda oculto sin que se pueda apreciar ningún sistema de sujeción.

Una de las mayores ventajas de este herraje es la poca profundidad que restamos al armario. Únicamente se descuenta el espesor de la puerta que puede ir de 19 a 45 mm.

SUMMARY

This system allows keeping the hanging doors lined up on the same plane. It also permits to manufacture closets of any size, where the fittings are hidden and the subjection can't be seen.

One of the great advantages of this system is that it takes very little depth from the closet. We could say than no more than the thickness of the door that is between 19 to 45 mm.



MUNICH BZ

ADINOR

S 20 BZ
S 20 KG. MUEBLE ALTO
20 KG. WALL CUPBOARD

S 20 BZ
S 20 KG. MUEBLE BAJO
20 KG. FLOOR CUPBOARD

M 35 BZ
M 35 KG.
M 35 KG.

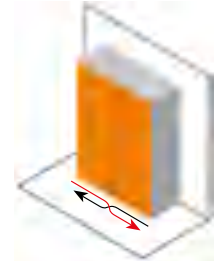
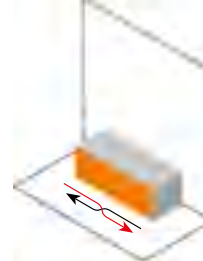
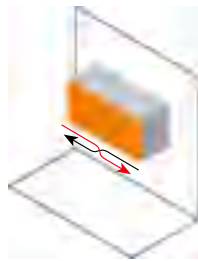

Medidas \ Measures

1200 mm.
1400 mm.
1600 mm.
1800 mm.
2000 mm.
2200 mm.
2400 mm.
2600 mm.
2800 mm.
3000 mm.
3200 mm.
3400 mm.
3600 mm.
3800 mm.
4000 mm.

REF.	REF.	REF.
MUNBS20A.1200	MUNBS20B.1200	MUNBM35.1200
+ MUNBS20A.1400	+ MUNBS20B.1400	+ MUNBM35.1400
+ MUNBS20A.1600	+ MUNBS20B.1600	+ MUNBM35.1600
MUNBS20A.1800	MUNBS20B.1800	MUNBM35.1800
+ MUNBS20A.2000	+ MUNBS20B.2000	+ MUNBM35.2000
+ MUNBS20A.2200	+ MUNBS20B.2200	+ MUNBM35.2200
MUNBS20A.2400	MUNBS20B.2400	MUNBM35.2400
+ MUNBS20A.2600	+ MUNBS20B.2600	+ MUNBM35.2600
+ MUNBS20A.2800	+ MUNBS20B.2800	+ MUNBM35.2800
+ MUNBS20A.3000	+ MUNBS20B.3000	+ MUNBM35.3000
-	-	+ MUNBM35.3200
-	-	+ MUNBM35.3400
-	-	+ MUNBM35.3600
-	-	+ MUNBM35.3800
-	-	+ MUNBM35.4000

+ BAJO PEDIDO / UNDER REQUEST

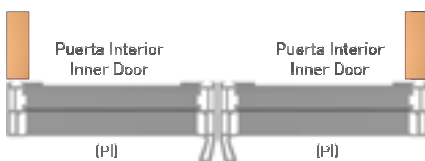
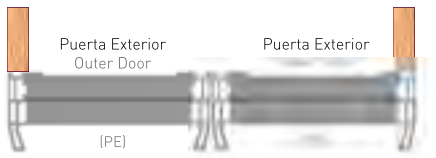

KIT PI
KIT PUERTA INTERIOR
INNER DOOR SET

KIT PE
KIT PUERTA EXTERIOR
OUTER DOOR SET

KIT FALDÓN M35-M50
KIT FALDÓN SUPERIOR / INFERIOR M35-M50
M35-M50 UPPER & LOWER CONNECTION PROFILE

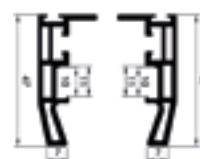
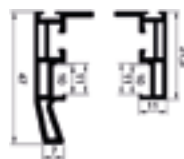

Contenido Kit
1x2,7m. Tirador torino interior
1x2,7m. Tirador torino exterior
2x2,7m. Reductor PVC vidrio 4-5mm.
2x2,7m. Cepillo 7x6

Kit Elements
1x2,7m. Torino Inner handle profile
1x2,7m. Torino Outer handle profile
2x2,7m. PVC Gasket 4-5mm. glass
2x2,7m. 7x6 Brush

Contenido Kit
2x2,7m. Tirador Torino exterior
2x2,7m. Reductor PVC vidrio 4-5mm.
2x2,7m. Cepillo 7x6

Kit Elements
2x2,7m. Torino Inner handle profile
2x2,7m. PVC Gasket 4-5mm. glass
2x2,7m. 7x6 Brush

Contenido Kit
2un. Faldón superior e inferior BZ
2un. Reductor PVC vidrio 4-5mm.
8un. Tensor unión perfiles + tornillos

Kit Elements
2un. BZUpper and lower connection profile
2un. PVC Gasket 4-5mm. glass
8un. Perpendicular Joint + screws

ACABADOS

FINISHINGS

ANODIZADOS	ANODIZED	REF.	REF.	KIT 1,2 m.	KIT 1,6 m.
Plata Mate	Natural Anodized	825KPI.APM	835KPE.APM	MUNKF.APM1.2	MUNKF.APM1.6

M 50 BZ

M 50 KG.
M 50 KG.

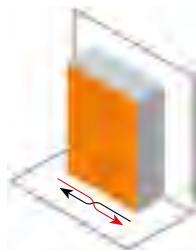

M 70 BZ

M 70 KG.
M 70 KG.

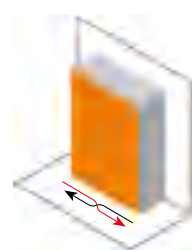

Medidas \ Measures

	REF.	REF.
1100-1399 mm.	-	-
1400-1599 mm.	-	-
1600-1799 mm.	+ MUNBM50.1600	+ MUNBL70.1600
1800-1999 mm.	MUNBM50.1800	MUNBL70.1800
2000-2199 mm.	MUNBM50.2000	MUNBL70.2000
2200-2399 mm.	+ MUNBM50.2200	+ MUNBL70.2200
2400-2599 mm.	MUNBM50.2400	MUNBL70.2400
2600-2799 mm.	+ MUNBM50.2600	+ MUNBL70.2600
2800-2999 mm.	MUNBM50.2800	MUNBL70.2800
3000-3199 mm.	+ MUNBM50.3000	+ MUNBL70.3000
3200-3399 mm.	+ MUNBM50.3200	MUNBL70.3200
3400-3599 mm.	+ MUNBM50.3400	+ MUNBL70.3400
3600-3799 mm.	+ MUNBM50.3600	+ MUNBL70.3600
3800-3999 mm.	+ MUNBM50.3800	+ MUNBL70.3800

+ BAJO PEDIDO / UNDER REQUEST

KIT TENSOR VIDRIO

KIT TENSOR VIDRIO (2un.)
STRAIGHTENER GLASS SET (2un.)

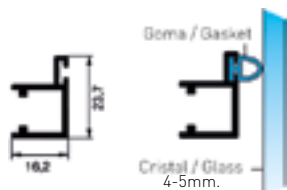

KIT TENSOR MADERA

KIT TENSOR MADERA (2un.)
STRAIGHTENER WOOD SET (2un.)

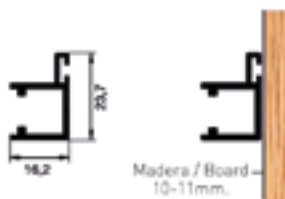

KIT H

KIT H (2un.)
H SET (2un.)



Contenido Kit

2un.	Perfil tensor vidrio
1un.	Goma reductora Tensor Vidrio
4un.	Tensor unión perfiles + tornillos

Kit Elements

2un.	Straightener profile for glass
1un.	Gasket for 4-5mm. Glass
4un.	Perpendicular Joint + screws

Contenido Kit

2un.	Perfil tensor madera
4un.	Tensor unión perfiles + tornillos

Kit Elements

2un.	Straightener profile for wood
4un.	Perpendicular Joint + screws

Contenido Kit

2un.	Perfil H
4un.	Reductor PVC vidrio 4-5mm.
4un.	Tensor unión perfiles + tornillos

Kit Elements

2un.	H Profile
4un.	PVC Gasket 4-5mm. glass
4un.	Perpendicular Joint + screws

KIT 1,2 m.

KIT 1,6 m.

KIT 1,2 m.

KIT 1,6 m.

KIT 1,2 m.

KIT 1,6 m.

REF.

REF.

REF.

REF.

REF.

REF.

866KTV.APM1.2

866KTV.APM1.6

867KTM.APM1.2

867KTM.APM1.6

865KH.APM1.2

865KH.APM1.6

MUNICH BZ

COMPLEMENTOS

COMPLEMENTS

ADINOR

TIRADOR DE EMBUTIR 150x20mm.

150x20mm. HANDLE



REF.
MUN800

HERRAJE FIJACIÓN PERFLERÍA A M-35 / M-50 MUNICH BZ

ASSEMBLY BRACKET FOR M-35 / M-50 MUNICH BZ UPPER & LOWER CONNECTION PROFILE



REF.
MUNM35-50T

TIRADOR ASA

HANDLE



REF.
MUN810

**INSTRUCCIONES
DE MONTAJE**
ASSEMBLY INSTRUCTIONS

DESCÁRGATE LAS INSTRUCCIONES COMPLETAS EN:
www.adinor.info/instrucciones-de-montaje
(Instrucciones montaje SISTEMA MUNICH BZ)

DOWNLOAD THE COMPLETE ASSEMBLY INSTRUCTIONS
www.adinor.info/instrucciones-de-montaje
(MUNICH BZ)

SISTEMAS DE PUERTAS CORREDERAS PARA ARMARIOS

CLOSET SLIDING DOORS SYSTEMS

SM 38

S57 43

S70 47

S80 73

S85 91

S90 102

COMPLEMENTOS COMUNES 106
COMMON COMPLEMENTS

SERIE M

M SERIE





SERIE M

M SERIE

ADINOR

UGI

GUÍA INFERIOR UGI
UGI LOWER RAIL

UGIP

GUÍA INFERIOR UGIP
UGIP LOWER RAIL

UGIA

GUÍA INFERIOR UGIA
UGIA LOWER RAIL

GIAE

GUÍA INFERIOR GIAE
GIAE LOWER RAIL

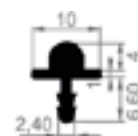
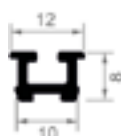
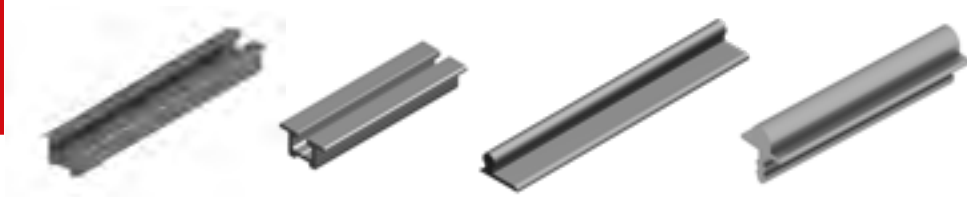

6m. Condiciones especiales de envío
6m. Special shipping conditions

ACABADOS	FINISHINGS	Longitud / Length : 6 m.	Longitud / Length : 6 m.	Longitud / Length : 6 m.	Longitud / Length : 6 m.
LACADOS	COATED	REF.	REF.	REF.	REF.
Negro Mate	Mat Black	134.L.NM	-	-	-
Blanco Mate Ral9010	White Mat Ral9010	134.L.BM	-	-	-
ANODIZADOS	ANODIZED	REF.	REF.	REF.	REF.
Plata Mate	Natural Anodized	134.A.PM	124.A.PM	1341.A.PM	129.A.PM
Natural	Natural	-	-	-	-

CROQUIS DE MONTAJE ASSEMBLY INSTRUCTIONS



GIAS

GUÍA INFERIOR GIAS
GIAS LOWER RAIL

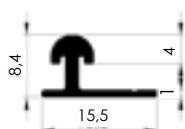

AL19mm

TIRADOR AL 19mm
19mm AL HANDLE PROFILE

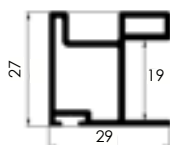

MNT16mm

TIRADOR MNT 16mm
16mm MNT HANDLE PROFILE

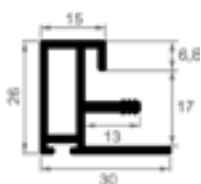
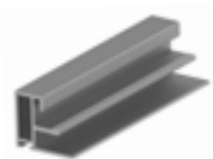

TIRADOR 30x28

TIRADOR RECTO 30x28 19mm.
19mm. 30x28 HANDLE PROFILE

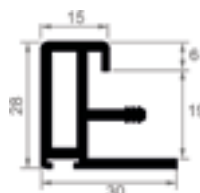
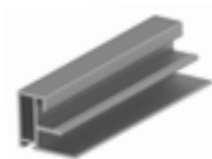

Longitud / Length : 6 m.	Longitud / Length : 4,8 m.	Longitud / Length : 4,65 m.	Longitud / Length : 4,80 m.
REF.	REF.	REF.	REF.
-	-	-	-
REF.	REF.	REF.	REF.
-	140AL.A.PM	1569.A.PM	140IR.A.PM
1298.A.N	-	-	-

COMPLEMENTOS

COMPLEMENTS

RODABLOC REM (PARA EMBUTIR)

REM LOWER ROLLER



REF.	Descripción	Description
1755	Rodabloc RR (Rueda Quilla) Guía Inferior UGI, UGIP	RR Lower Rail For UGI, UGIP Lower Rail

RODABLOC RR QUILLA

RR LOWER ROLLER



REF.	Descripción	Description
177	Rodabloc RR (Rueda Quilla) Guía Inferior UGI, UGIP	RR Lower Rail For UGI, UGIP Lower Rail

RODABLOC RR ACANALADA

RR LOWER ROLLER



REF.	Descripción	Description
176	Rodabloc RR (Rueda Acanalada) Guía Inferior GIAE, UGIA	RR Lower Rail For GIAE, UGIA Lower Rail

RODABLOC REC QUILLA

REC LOWER ROLLER



REF.	Descripción	Description
1788	Rodabloc REC (Rueda Quilla) Guía Inferior GIO, GIEC, G170, G13P, UGI, UGIP	REC Lower Rail For GIO, GIEC, G170, G13P, UGI, UGIP Lower Rail

GUIADOR SUPERIOR (superficie)

UPPER GUIDELINE (surface mounting)



REF.	Descripción	Description
175	Guiador para UGI, UGIP	UGI, UGIP Wideline

GUIADOR SUPERIOR (PARA EMBUTIR)

UPPER GUIDELINE RECESSED



REF.	Descripción	Description
1758	Guiador para UGI, UGIP	UGI, UGIP Wideline

CUÑA INFERIOR DE FRENO DOBLE PATILLA UGI, UGIP

UGI, UGIP BOTTOM STOPPER



REF.	Descripción	Description
1632	Freno para UGI, UGIP	UGI, UGIP Bottom stopper

CUÑA INFERIOR DE FRENO GIO, UGI, GI4F

GIO, UGI, GI4F BOTTOM STOPPER



REF.	Descripción	Description
1631	Freno para UGI, UGIP	UGI, UGIP Bottom stopper

TAPÓN FINAL GUÍA UGIP

UGIP END COVER



REF.	Descripción	Description
1639	Tapón UGIP	UGIP End cover

RUEDA INFERIOR AS

AS BOTTOM ROLLER



REF.	Descripción	Description
1752	Rueda para guía AS	AS Roller track

GUIADOR SUPERIOR AS

AS UPPER GUIDELINE



REF.	Descripción	Description
1753	Guiador superior guía AS	For AS Rail

SERIE 57

57 SERIE

57mm

ADINOR

GS57

GUÍA SUPERIOR GS57
GS57 UPPER RAIL

UGI

GUÍA INFERIOR UGI
UGI LOWER RAIL

IMD16mm

TIRADOR IMD 16mm
16mm IMD HANDLE PROFILE

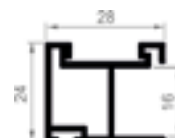
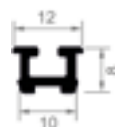
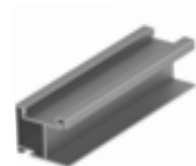

6m. Condiciones especiales de envío
6m. Special shipping conditions

ACABADOS

FINISHINGS

Longitud / Length : 6 m.

Longitud / Length : 6 m.

Longitud / Length : 2,5 m.

ANODIZADOS

ANODIZED

REF.

REF.

REF.

Plata Mate

Natural Anodized

116.A.PM

134.A.PM

156.A.PM

COMPLEMENTOS COMPLEMENTS

RODABLOC REM (PARA EMBUTIR)

REM LOWER ROLLER



REF.	Descripción	Description
1755	Rodabloc RR (Rueda Quilla) Guía Inferior UGI, UGIP	RR Lower Rail For UGI, UGIP Lower Rail

CABALLETE METÁLICO CON COJINETE S57

S57 METALLIC UPPER ROLLER WITH BEARINGS



REF.
1565

AMORTIGUADOR DE CIERRE GS57 25 KG.

SELF-CLOSING SYSTEM UP TO 25 KG



REF.
160AMKITS57.25

AMORTIGUADOR DE CIERRE GS57 40KG.

SELF-CLOSING SYSTEM UP TO 40 KG



REF.
160AMKITS57.40

AMORTIGUADOR DE CIERRE GS57 60 KG.

SELF-CLOSING SYSTEM UP TO 60 KG



REF.
160AMKITS57.60

AMORTIGUADOR DE CIERRE GS57 80 KG.

SELF-CLOSING SYSTEM UP TO 80 KG



REF.
160AMKITS57.80

CROQUIS DE MONTAJE

ASSEMBLY INSTRUCTIONS

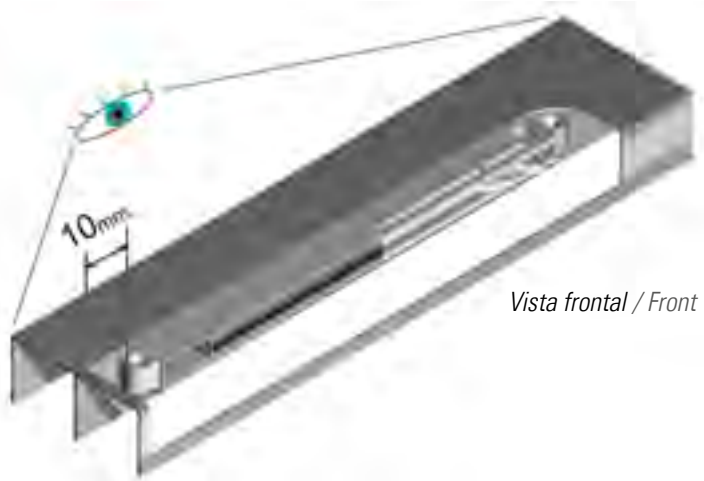

Vista frontal / Front view

VISTA
FRONTAL

FRONT
VIEW

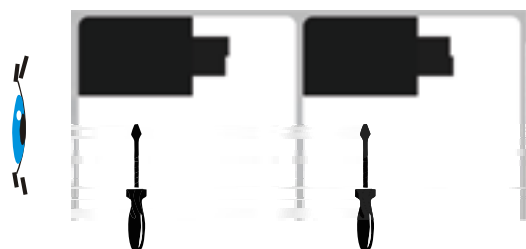

KG	X
25	155mm.
40	
60	235mm.
80	





57mm

ADINOR

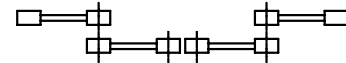
Para solape según dibujo esquema
Doors superposed according to drawing



ALTURA PUERTA / DOOR HEIGHT

		SIN AMORTIGUADOR WITHOUT SELF CLOSING SYSTEM	CON AMORTIGUADOR WITH SELF CLOSING SYSTEM
		GS57 	GS57 
UGI		H - 24	H - 34

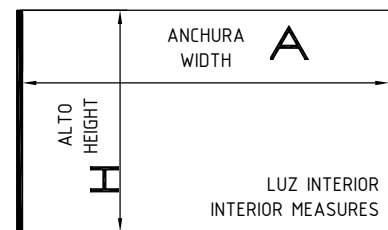

ANCHURA DEL TABLERO / BOARD WIDTH (C)

		IMD 16mm. 
2 PUERTAS	2 BOARDS	$\frac{A - 36}{2}$
3 PUERTAS	3 BOARDS	$\frac{A - 40}{3}$
4 PUERTAS	4 BOARDS	$\frac{A - 72}{4}$

LONGITUD CORTE PERFIL H, U / H, U PROFILE HEIGHT

IMD 16mm. 
C - 23

SERIE 70

70 SERIE



70mm

ADINOR

GSO

GUÍA SUPERIOR GSO
GSO UPPER RAIL

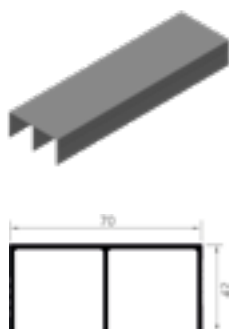

GSEC

GUÍA SUPERIOR GSEC
GSEC UPPER RAIL

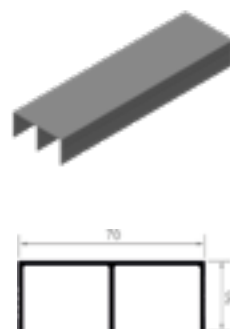

GSU

GUÍA SUPERIOR GSU
GSU UPPER RAIL

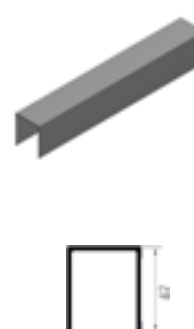

GI70

GUÍA INFERIOR GI70
GI70 LOWER RAIL

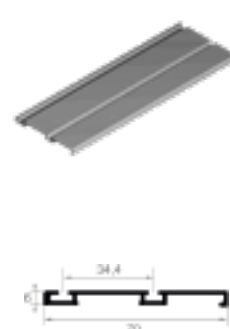

BAJO PEDIDO / UNDER REQUEST

ACABADOS	FINISHINGS	Longitud / Length : 6 m.	Longitud / Length : 6 m.	Longitud / Length : 6 m.	Longitud / Length : 6 m.
LACADOS	COATED	REF.	REF.	REF.	REF.
Blanco Brillo RAL 9010	White RAL9010	112.L.B	114.L.B	115.L.B	139.L.B
Blanco Mate RAL 9010	Mat white RAL9010	112.L.BM	-	-	139.L.BM
Blanco Mate RAL 9003	Mat white RAL9003	112.L.BM03	-	-	139.L.BM03
Negro Mate	Mat black	112.L.NM	-	115.L.NM	139.L.NM
Antracita	Anthracite	112.L.ANT	-	-	139.L.ANT
Oro	Gold	112.L.O	-	-	139.L.O
ANODIZADOS	ANODIZED	REF.	REF.	REF.	REF.
Bronce Brillo Repulido	Bronce	112.A.BR	-	-	139.A.BR
Bronce Mate	Bronce Mat	-	-	-	-
Plata Brillo Repulido	Polished Silver	112.A.P	-	-	139.A.P
Plata Mate	Natural Anodized	112.A.PM	114.A.PM	115.A.PM	139.A.PM
Inox Brillo Repulido	Inox	112.A.X	-	-	139.A.X
MELAMINA	MELAMINE	REF.	REF.	REF.	REF.
Roble RO 444	Oak	112.M.RBRO	-	-	139.M.RBRO
Roble 562	Oak	112.M.RB562	-	-	139.M.RB562
Sapely D2517	Sapely	112.M.SPD	-	-	139.M.SPD
Cerezo Duero	Cherry Tree	112.M.CZD	-	-	139.M.CZD
Cerezo Tajo	Cherry Tree	112.M.CZT	-	-	139.M.CZT
Haya Blanca Almijara	Beech Tree	112.M.Y	-	-	139.M.Y
Haya Vapor. 428	Steam Beech	112.M.YV	-	-	139.M.YV
Wengue Congo	Wengue	112.M.W	-	-	139.M.W
Blanco Rebarnizable	White	112.M.MR	-	-	139.M.MR
Nogal Montisa	Montisa Walnut	112.M.NG	-	-	139.M.NG
Textil Cancun	Textil Cancun	112.M.TXCANC	-	-	139.M.TXCANC
MADERA	NATURAL WOOD	REF.	REF.	REF.	REF.
Roble Francés	Oak	112.C.RB	-	-	139.C.RB
Sapely	Sapely	112.C.SP	-	-	139.C.SP
Cerezo	Cherry Tree	112.C.CZ	-	-	139.C.CZ
Pino	Pine	112.C.PN	-	-	139.C.PN
Haya Blanca	Beech Tree	112.C.Y	-	-	139.C.Y
Haya Vaporizada	Steam Beech	112.C.YV	-	-	139.C.YV
VINILO	VINYL	REF.	REF.	REF.	REF.
Blanco Sil	Blanco Sil	112.V.BS	-	-	139.V.BS
Blanco Perla Touch	Blanco Perla Touch	112.V.BP	-	-	139.V.BP
Blanco RAL 9003	Blanco RAL 9003	112.V.9003	-	-	139.V.9003
Halifax Natural	Natural Halifax	112.V.HN	-	-	139.V.HN
Halifax Tabaco	Halifax Tabaco	112.V.HT	-	-	139.V.HT
Halifax Blanco	White Halifax	112.V.HB	-	-	139.V.HB
Wengue Duero	Wengue Duero	112.V.W	-	-	139.V.W
Palo Rosa Touch	Palo Rosa Touch	112.V.PRT	-	-	139.V.PRT

6m. Condiciones especiales de envío
6m. Special shipping conditions

70mm

ADINOR

RT16mm.

TIRADOR DE HOJA RT
RT HANDLE PROFILE

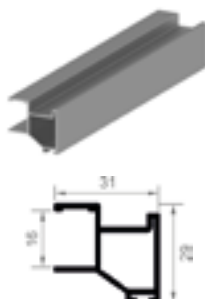

FO16mm.

TIRADOR DE HOJA FO
FO HANDLE PROFILE

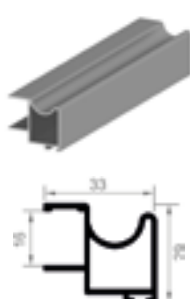

GT16mm.

TIRADOR DE HOJA GT
GT HANDLE PROFILE

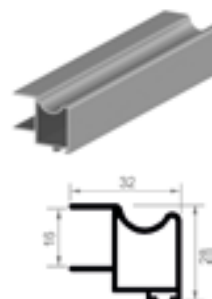

AEC16mm.

TIRADOR DE HOJA AEC
AEC HANDLE PROFILE

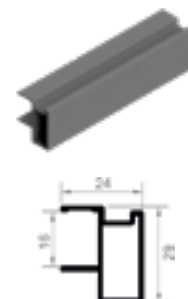

BAJO PEDIDO / UNDER REQUEST

ACABADOS	FINISHINGS	Longitud / Length : 2,5 m.	Longitud / Length : 2,5 m.	Longitud / Length : 2,3 m.	Longitud / Length : 2,5 m.
LACADOS	COATED	REF.	REF.	REF.	REF.
Blanco Brillo Ral 9010	White	+ 1463.L.B	+ 145.L.B	+ + 147.L.B	-
Blanco Mate Ral 9010	Mat White Ral 9010	1463.L.BM	145.L.BM	-	-
Blanco Mate Ral 9003	Mat White Ral 9003	1463.L.BM03	145.L.BM03	147.L.BM03	-
Negro Mate	Mat Black	1463.L.NM	145.L.NM	147.L.NM	-
Antracita	Anthracite	1463.L.ANT	145.L.ANT	-	-
Oro	Gold	1463.L.O	145.L.O	-	-
ANODIZADOS	ANODIZED	REF.	REF.	REF.	REF.
Bronce Brillo Repulido	Bronce	1463.A.BR	145.A.BR	-	-
Plata Brillo Repulido	Polished Silver	1463.A.P	-	-	-
Plata Mate	Natural Anodized	+ 1463.A.PM	+ 145.A.PM	+ + 147.A.PM	1461.A.PM
Inox Brillo Repulido	Inox	1463.A.X	145.A.X	-	-
MELAMINA	MELAMINE	REF.	REF.	REF.	REF.
Roble RO 444	Oak	+ 1463.M.RBRO	+ 145.M.RBRO	147.M.RBRO	-
Roble 562	Oak	1463.M.RB562	145.M.RB562	-	-
Sapely D2517	Sapely	1463.M.SPD	145.M.SPD	147.M.SPD	-
Cerezo Duero	Cherry Tree	1463.M.CZD	145.M.CZD	147.M.CZD	-
Cerezo Tajo	Cherry Tree	1463.M.CZT	145.M.CZT	147.M.CZT	-
Haya Blanca Almijara	Beech Tree	1463.M.Y	145.M.Y	147.M.Y	-
Haya Vapor. 428	Steam Beech	1463.M.YV	145.M.YV	147.M.YV	-
Wengue Congo	Wengue	1463.M.W	145.M.W	147.M.W	-
Blanco Rebornizable	White	+ 1463.M.MR	145.M.MR	147.M.MR	-
Nogal Montisa	Montisa Walnut	-	145.M.NG	-	-
Textil Cancun	Textil Cancun	1463.M.TXCANC	-	-	-
MADERA	NATURAL WOOD	REF.	REF.	REF.	REF.
Roble Francés	Oak	1463.C.RB	145.C.RB	147.C.RB	-
Sapely	Sapely	1463.C.SP	145.C.SP	147.C.SP	-
Cerezo	Cherry Tree	1463.C.CZ	145.C.CZ	147.C.CZ	-
Pino	Pine	1463.C.PN	145.C.PN	147.C.PN	-
Haya Blanca	Beech Tree	1463.C.Y	145.C.Y	147.C.Y	-
Haya Vaporizada	Steam Beech	1463.C.YV	145.C.YV	147.C.YV	-
VINILO	VINYL	REF.	REF.	REF.	REF.
Blanco Sil	Blanco Sil	1463.V.BS	-	-	-
Blanco Perla Touch	Blanco Perla Touch	1463.V.BP	-	-	-
Blanco RAL 9003	Blanco RAL 9003	1463.V.9003	-	-	-
Halifax Natural	Halifax Natural	1463.V.HN	-	-	-
Halifax Tabaco	Halifax Tabaco	1463.V.HT	-	-	-
Halifax Blanco	Halifax White	1463.V.HB	-	-	-
Wengue Duero	Wengue Duero	1463.V.W	-	-	-
Palo Rosa Touch	Palo Rosa Touch	1463.V.PRT	-	-	-

GA16mm.

TIRADOR DE HOJA GA
GA HANDLE PROFILE

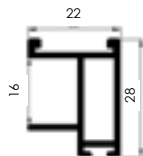

RT10mm.

TIRADOR DE HOJA RT
RT HANDLE PROFILE



FO10mm.

TIRADOR DE HOJA FO
FO HANDLE PROFILE

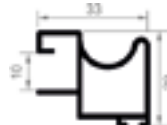

CRVO10mm.

TIRADOR DE HOJA CRVO
CRVO HANDLE PROFILE

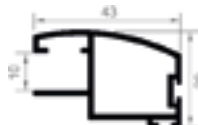
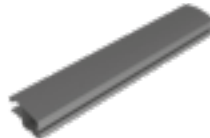

JP10mm.

TIRADOR DE HOJA JP
JP HANDLE PROFILE



HE10mm.

TIRADOR DE HOJA HE
HE HANDLE PROFILE

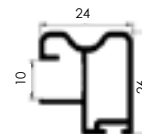

+ Longitud / Lenght: **2,5 m.**

+ Longitud / Lenght: **2,5 m.**

Longitud / Lenght : 2,7 m.	Longitud / Lenght : 2,7 m.	Longitud / Lenght : 2,7 m.	Longitud / Lenght : 2,6 m.	Longitud / Lenght : 2,5 m.	Longitud / Lenght : 2,6 m.
REF.	REF.	REF.	REF.	REF.	REF.
-	14631.L.B	1451.L.B	144.L.B	143.L.B	1479.L.B.26
-	-	-	-	-	-
-	-	-	-	-	-
-	14631.L.NM	1451.L.NM	-	-	-
-	-	-	-	-	-
-	14631.L.O	1451.L.O	-	-	-
REF.	REF.	REF.	REF.	REF.	REF.
-	14631.A.BR	1451.A.BR	-	-	-
-	-	-	-	143.A.P	-
146.A.PM	+ 14631.A.PM	+ 1451.A.PM	144.A.PM	143.A.PM	1479.A.PM.26
-	14631.A.X	1451.A.X	-	-	-
REF.	REF.	REF.	REF.	REF.	REF.
-	14631.M.RBRO	1451.M.RBRO	+ 144.M.RBRO	-	-
-	-	-	+ 144.M.RB562	-	-
-	14631.M.SPD	1451.M.SPD	+ 144.M.SPD	-	-
-	14631.M.CZD	1451.M.CZD	+ 144.M.CZD	-	-
-	14631.M.CZT	-	+ 144.M.CZT	-	-
-	14631.M.Y	1451.M.Y	+ 144.M.Y	-	-
-	14631.M.YV	1451.M.YV	+ 144.M.YV	-	-
-	14631.M.W	1451.M.W	+ 144.M.W	-	-
-	14631.M.MR	1451.M.MR	+ 144.M.MR	-	-
-	-	-	-	-	-
-	-	-	-	-	-
REF.	REF.	REF.	REF.	REF.	REF.
-	14631.C.RB	1451.C.RB	+ 144.C.RB	-	-
-	14631.C.SP	1451.C.SP	+ 144.C.SP	-	-
-	14631.C.CZ	1451.C.CZ	+ 144.C.CZ	-	-
-	14631.C.PN	1451.C.PN	+ 144.C.PN	-	-
-	14631.C.Y	1451.C.Y	+ 144.C.Y	-	-
-	14631.C.YV	1451.C.YV	+ 144.C.YV	-	-
REF.	REF.	REF.	REF.	REF.	REF.
-	14631.V.BS	-	-	-	-
-	14631.V.BP	-	-	-	-
-	14631.V.9003	-	-	-	-
-	14631.V.HN	-	-	-	-
-	14631.V.HT	-	-	-	-
-	14631.V.HB	-	-	-	-
-	14631.V.W	-	-	-	-
-	14631.V.PRT	-	-	-	-

70mm

ADINOR

MINVH10mm

TIRADOR MINVH
MINVH HANDLE PROFILE



FALDÓN MIN10mm.

PERFIL FALDON SUP/INF
UPPER/LOWER
CONNECTION PROFILE



EX10mm.

TIRADOR HOJA EX
EX HANDLE PROFILE

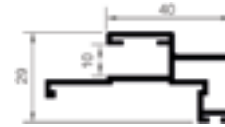

VHBT10mm.

TIRADOR VHBT 10mm.
10mm. VHBT HANDLE PROFILE

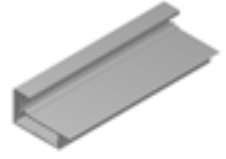

6m. Condiciones especiales de envío
6m. Special shipping conditions

BAJO PEDIDO / UNDER REQUEST

ACABADOS	FINISHINGS	Longitud / Length : 2.7 m.	Longitud / Length : 6 m.	Longitud / Length : 2.7 m.	Longitud / Length : 2.6 m.
LACADOS	COATED	REF.	REF.	REF.	REF.
Blanco Brillo Ral 9010	White	C110.L.B	C210.L.B	1475.L.B	BT100.L.B
Blanco Mate Ral 9010	Mat White	-	C210.L.BM	-	-
Blanco Mate Ral 9003	Mat White	-	C210.L.BM03	-	-
Negro Mate	Mat Black	C110.L.NM	C210.L.NM	-	BT100.L.NM
Antracita	Anthracite	-	-	-	-
ANODIZADOS	ANODIZED	REF.	REF.	REF.	REF.
Bronce Brillo Repulido	Bronce	-	-	-	-
Plata Brillo Repulido	Polished Silver	C110.A.P	C210.A.P	-	BT100.A.P
Plata Mate	Natural Anodized	C110.A.PM	C210.A.PM	1475.A.PM	BT100.A.PM
Inox Brillo Repulido	Inox	-	-	-	-
MELAMINA	MELAMINE	REF.	REF.		
Roble A0562	Oak	C110.M.RB562	C210.M.RB562		
Roble RO 444	Oak	C110.M.RBRO	C210.M.RBRO		
Sapely D2517	Sapely	-	-		
Roble Luna	Oak	-	-		
Cerezo Duero	Cherry Tree	-	-		
Cerezo Tajo	Cherry Tree	-	-		
Haya Blanca Almijara	Beech Tree	-	-		
Haya Vapor. 428	Steam Beech	C110.M.YV	C210.M.YV		
Wengue Congo	Wengue	C110.M.W	C210.M.W		
Blanco Rebornizable	White	C110.M.MR	C210.M.MR		
MADERA	NATURAL WOOD	REF.	REF.		
Roble Francés	Oak	C110.C.RB	C210.C.RB		
Sapely	Sapely	C110.C.SP	C210.C.SP		
Cerezo	Cherry Tree	C110.C.CZ	C210.C.CZ		
Pino	Pine	C110.C.PN	C210.C.PN		
Haya Blanca	Beech Tree	C110.C.Y	C210.C.Y		
Haya Vaporizada	Steam Beech	C110.CYV	-		

ESCUADRA 42x42 PERFIL BT + 4 TORNILLOS

42X42 INNER CONNECTION ANGLE FOR BT + 4 SCREWS



REF.
BT300

HBT10mm.

PERFIL H BT 10mm.
10mm. BT H PROFILE

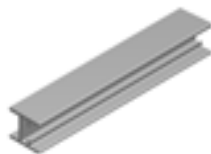

AEC18mm.

TIRADOR DE HOJA AEC
AEC HANDLE PROFILE

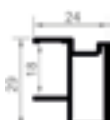

JO-18mm.

TIRADOR DE HOJA JO
JO HANDLE PROFILE

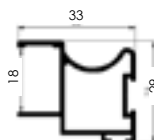

RT18mm.

TIRADOR DE HOJA RT
RT HANDLE PROFILE

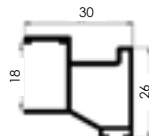

RO18mm.

TIRADOR DE HOJA RO
RO HANDLE PROFILE



RO18-10mm.

TIRADOR DE HOJA RO
RO HANDLE PROFILE

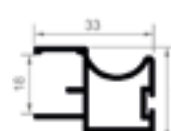

Longitud / Length : 6 m.	Longitud / Length : 2,7 m.	Longitud / Length : 2,7 m.	Longitud / Length : 2,7 m.	Longitud / Length : 2,7 m.	Longitud / Length : 2,7 m.
REF.	REF.	REF.	REF.	REF.	REF.
BT200.L.B	-	14035.L.B	-	1403.L.B	-
-	-	-	-	-	-
-	-	-	1404.L.BM03	1403.L.BM03	-
BT200.L.NM	-	-	1404.L.NM	1403.L.NM	-
-	-	-	1404.L.ANT	1403.L.ANT	-
REF.	REF.	REF.	REF.	REF.	REF.
-	-	-	1404.A.BR	1403.A.BR	-
BT200.A.P	-	-	-	-	-
BT200.A.PM	14018.A.PM	14035.A.PM	1404.A.PM	1403.A.PM	1408.A.PM
-	-	-	1404.A.X	1403.A.X	-
-	-	-	-	REF.	REF.
-	-	-	-	-	-
-	-	-	-	1403.M.RBRO	-
-	-	-	-	-	-
-	-	-	-	-	-
-	-	-	-	-	-
-	-	-	-	-	-
-	-	-	-	1403.M.W	-
-	-	-	-	-	-
-	-	-	-	REF.	REF.
-	-	-	-	1403.C.RB	-
-	-	-	-	-	-
-	-	-	-	-	-
-	-	-	-	-	-
-	-	-	-	-	-

ESCUADRA REMATE 42x5 PERFIL BT + 3 TORNILLOS

42X5 INNER CONNECTION ANGLE FOR BT + 3 SCREWS



REF.
BT301

COMPLEMENTOS COMPLEMENTS

RODABLOC RR QUILLA

RR LOWER ROLLER



REF.	Descripción	Description
177	Rodabloc RR (Rueda Quilla) Guía Inferior GIO, GIEC, GI70, GI3P, UGI, UGIP	RR Lower Rail For GIO, GIEC, GI70, GI3P, UGI, UGIP Lower Rail

RODABLOC RR QUILLA BLOQUEO FRONTAL

RR LOWER ROLLER WITH FRONT LOCK



REF.	Descripción	Description
171	Rodabloc RR Bloqueo (Quilla) Guía Inferior GIO, GIEC, GI70, GI3P, UGIP, GI50, GI80	Front lock RR Lower Rail For GIO, GIEC, GI70, GI3P, UGIP, GI50, GI80 Lower Rail

RODABLOC FR

FR LOWER ROLLER



REF.	Descripción	Description
174	Rodabloc FR (Rueda Quilla) Guía Inferior GIO, GIEC, GI70, GI3P, UGI, UGIP	FR Lower Rail For GIO, GIEC, GI70, GI3P, UGI, UGIP Lower Rail

CONJUNTO RUEDAS EX

EX ROLLER SET



REF.
178

CABALLETE METÁLICO CON COJINETES Y GOMA

METALLIC UPPER ROLLER WITH BEARINGS



REF.	Descripción	Description
165M	CBSMG (Con Cojinetes)	CBSMG (With Bearings)

RODABLOC RR ACANALADA

RR LOWER ROLLER



REF.	Descripción	Description
176	Rodabloc RR (Rueda Acanalada) Guía Inferior GI20, UGIA	RR Lower Rail For GI20, UGIA Lower Rail

RODABLOC RDO

RDO LOWER ROLLER



REF.	Descripción	Description
173	Rodabloc RDO (Rueda Acanalada) Guía Inferior GICO	RDO Lower Rail For GICO, Lower Rail

RODABLOC REC QUILLA

REC LOWER ROLLER



REF.	Descripción	Description
1788	Rodabloc REC (Rueda Quilla) Guía Inferior GIO, GIEC, GI70, GI3P, UGI, UGIP	REC Lower Rail For GIO, GIEC, GI70, GI3P, UGI, UGIP Lower Rail

CABALLETE METÁLICO SIN COJINETES Y GOMA

METALLIC UPPER ROLLER WITHOUT BEARINGS



REF.	Descripción	Description
1661	CBSMG (Sin Cojinetes)	CBSMG (Without Bearings)

CABALLETE METÁLICO CON COJINETES Y GOMA CSR10

CSR10 METALLIC UPPER ROLLER WITH BEARINGS



SOLO para tirador 18-19mm.
ONLY for 18-19mm. handle profile.

REF.	Descripción	Description
1655	CBR10 (Con Cojinetes)	CBSMG (With Bearings)

RODABLOC R10

R10 LOWER ROLLER



SOLO para tirador 18-19mm.
ONLY for 18-19mm. handle profile.

REF.	Descripción	Description
179	Rodabloc RR (Rueda Quilla) Guía Inferior GIO, GIEC, GI70, GI3P, UGI	RR Lower Rail For GIO, GIEC, GI70, GI3P, UGI Lower Rail

CABALLETE METÁLICO SIN COJINETES Y GOMA

METALLIC UPPER ROLLER WITHOUT BEARINGS



SOLO para tirador 18-19mm.
ONLY for 18-19mm. handle profile.

REF.	Descripción	Description
1662.SC.18	CBSMG (Sin Cojinetes)	CBSMG (Without Bearings)

ANTICABECEO - ANTIDESCARRILAMIENTO

DERAILMENT



REF.
182.S70

DESCÁRGATE LAS INSTRUCCIONES COMPLETAS EN:
www.adinor.info/instrucciones-de-montaje
(Video Sistema Anticabeceo)
DOWNLOAD THE COMPLETE ASSEMBLY INSTRUCTIONS

CUÑA INFERIOR DE FRENO GIO

GIO BOTTON STOPPER



REF.	Descripción	Description
1631	Guía Inferior GIO	GIO Lower Rail

CUÑA INFERIOR DE FRENO GI70-GIEC

GI70-GIEC BOTTON STOPPER



REF.	Descripción	Description
1633	Guía Inferior GI70-GIEC	GI70-GIEC Lower Rail

KIT DE HERRAJE ROLLER SET

KIT DE HERRAJE S70 - 16mm

S70 HARDWARE SET - 16mm



Ref. 177 - 2 Un.



Ref. 163 - 1 Un.



Ref. 165M - 2 Un.

3,9x12



Ref. HT12 - 16 Un.

REF.

177.S70.KIT

KIT DE HERRAJE S70 - 10mm

S70 HARDWARE SET - 10mm



Ref. 177 - 2 Un.



Ref. 163 - 1 Un.



Ref. 165M - 2 Un.

3,9x6,5



Ref. HT6.5 - 16 Un.

REF.

17710.S70.KIT

KIT DE HERRAJE S70 - Mini 10mm

S70 HARDWARE SET - Mini 10mm



Ref. 177 - 2 Un.



Ref. 163 - 1 Un.



Ref. C350 - 4 Un.



Ref. 165M - 2 Un.



Ref. C540 - 4 Un.

3,9x6,5



Ref. HT6.5 - 16 Un.

REF.

177M.S70.KIT

KIT DE HERRAJE S70 - 16mm

S70 HARDWARE SET - 16mm



Ref. 176 - 2 Un.



Ref. 163 - 1 Un.



Ref. 165M - 2 Un.

3,9x12



Ref. HT12 - 16 Un.

REF.

176.S70.KIT

KIT DE HERRAJE S70 - 18-19mm

S70 HARDWARE SET - 18-19mm

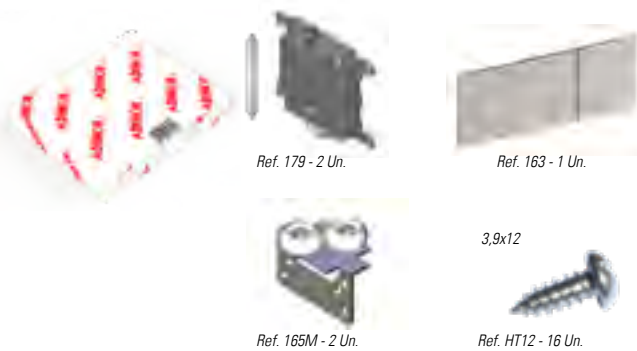

REF.
179.S70.KIT

KIT DE HERRAJE S70 - EX10mm

S70 HARDWARE SET - EX10mm



REF.
178.S70.KIT

KIT DE HERRAJE S70 - RDO

S70 HARDWARE SET - RDO



REF.
173.S70.KIT

KIT DE HERRAJE S70 - ECO 10-16mm

S70 HARDWARE SET - ECO 10-16mm

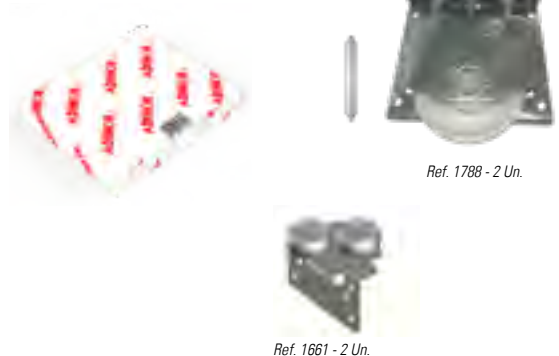

REF.
1788.S70.KIT

AMORTIGUADORES SOFT CLOSING SYSTEM

AMORTIGUADOR DE CIERRE GSO 15 KG.

SELF-CLOSING SYSTEM UP TO 15 KG



REF.
160AMORKIT15

x1

AMORTIGUADOR DE CIERRE GSO 25 KG.

SELF-CLOSING SYSTEM UP TO 25 KG



REF.
160AMORKIT25

x1

AMORTIGUADOR DE CIERRE GSO 40KG.

SELF-CLOSING SYSTEM UP TO 40 KG



REF.
160AMORKIT40

x1

AMORTIGUADOR DE CIERRE GSO 60 KG.
SELF-CLOSING SYSTEM UP TO 60 KG



REF.
160AMORKIT60

x1

AMORTIGUADOR DE CIERRE GSO 80 KG.
SELF-CLOSING SYSTEM UP TO 80 KG



REF.
160AMORKIT80

x1

AMORTIGUADOR DE CIERRE CENTRAL GSO
CENTRAL SELF-CLOSING SYSTEM



x1

REF.	Descripción	Description
160AMORKITC25	Amortiguador central 25 kg	Central Self Closing System 25 kg.
160AMORKITC	Amortiguador central 40 kg.	Central Self Closing System 40 kg.

AMORTIGUADORES FÁCIL MONTAJE (PATENTADO)

EASY ASSEMBLY SOFT CLOSING SYSTEM (PATENTED)

AMORTIGUADOR DE CIERRE IZQ.+DCH. GSO 15 KG. (sistema montaje rápido)
LEFT & RIGHT SELF-CLOSING SYSTEM UP TO 15KG. (EASY ASSEMBLY)



x2

REF.
160S70AMOKIT15

AMORTIGUADOR DE CIERRE IZQ.+DCH. GSO 25 KG. (sistema montaje rápido)
LEFT & RIGHT SELF-CLOSING SYSTEM UP TO 25KG. (EASY ASSEMBLY)



x2

REF.
160S70AMOKIT25

AMORTIGUADOR DE CIERRE IZQ.+DCH. GSO 40 KG. (sistema montaje rápido)
LEFT & RIGHT SELF-CLOSING SYSTEM UP TO 40KG. (EASY ASSEMBLY)



x2

REF.
160S70AMOKIT40

AMORTIGUADOR DE CIERRE IZQ.+DCH. GSO 60 KG. (sistema montaje rápido)
LEFT & RIGHT SELF-CLOSING SYSTEM UP TO 60KG. (EASY ASSEMBLY)



x2

REF.
160S70AMOKIT60

AMORTIGUADOR DE CIERRE IZQ.+DCH. GSO 80 KG. (sistema montaje rápido)
LEFT & RIGHT SELF-CLOSING SYSTEM UP TO 80KG. (EASY ASSEMBLY)



x2

REF.
160S70AMOKIT80

AMORTIGUADOR DE CIERRE IZQ.+DCH. GSO 100 KG. (sistema montaje rápido)
LEFT & RIGHT SELF-CLOSING SYSTEM UP TO 100KG. (EASY ASSEMBLY)



x2

REF.
160S70AMOKIT100

70mm MOLDURAS MOULDING

ADINOR

TAPETA_{70X11}

TAPETA DM
MDF FLAT ARCHITRAVE

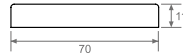

TAPETA_{150x8}

TAPETA DM
MDF FLAT ARCHITRAVE

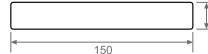

BATIENTE_{105x16}

BATIENTE DM
MDF DOOR STOP MOULDING

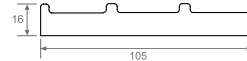

ALUMINIO BATIENTE_{70x12}

BATIENTE DE ALUMINIO
ALUMINIUM DOOR STOP
MOULDING

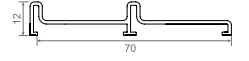

BAJO PEDIDO / UNDER REQUEST

ACABADOS	FINISHINGS	Longitud / Length : 2,75 m.	Longitud / Length : 3,66 m.	Longitud / Length : 2,8 m.	Longitud / Length : 2,75 m.
LACADOS	COATED	REF.	REF.	REF.	REF.
Blanco Brillo Ral 9010	White	-	-	-	480.L.B
Negro Mate	Mat Black	-	-	-	480.L.NM
Blanco Mate Ral 9010	Mat white	-	-	-	480.L.BM
Blanco Mate Ral 9003	Mat white	-	-	-	480.L.BM03
Antracita	Anthracite	-	-	-	480.L.ANT
Oro	Gold	-	-	-	480.L.O
ANODIZADOS	ANODIZED	REF.	REF.	REF.	REF.
Bronce Brillo Repulido	Bronce	-	-	-	480.A.BR
Plata Brillo Repulido	Polished Silver	-	-	-	480.A.P
Plata Mate	Natural Anodized	-	-	-	480.A.PM
Inox Brillo Repulido	Inox	-	-	-	480.A.X
MELAMINA	MELAMINE	REF.	REF.	REF.	REF.
Roble RO 444	Oak	432.M.RBRO	434.M.RBRO	485.M.RBRO	480.M.RBRO
Sapely D2517	Sapely	432.M.SPD	434.M.SPD	-	480.M.SPD
Cerezo Duero	Cherry Tree	432.M.CZD	434.M.CZD	-	480.M.CZD
Cerezo Tajo	Cherry Tree	432.M.CZT	-	-	480.M.CZT
Haya Blanca Almijara	Beech Tree	432.M.Y	434.M.Y	485.M.Y	480.M.Y
Haya Vapor. 428	Steam Beech	432.M.YV	434.M.YV	485.M.YV	480.M.YV
Wengue Congo	Wengue	432.M.W	434.M.W	485.M.W	480.M.W
Plata Mate	Natural Mat	432.M.PM	434.M.PM	485.M.PM	-
Blanco Rebornizable	White	432.M.MR	434.M.MR	485.M.MR	480.M.MR
Nogal Montisa	Montisa Walnut	432.M.NG	434.M.NG	-	480.M.NG
Textil Cancun	Textil Cancun	432.M.TXCANC	434.M.TXCANC	-	480.M.TXCANC
MADERA	NATURAL WOOD	REF.	REF.	REF.	REF.
Roble Francés	Oak	432.C.RB	434.C.RB	485.C.RB	480.C.RB
Sapely	Sapely	432.C.SP	434.C.SP	-	480.C.SP
Cerezo	Cherry Tree	432.C.CZ	434.C.CZ	485.C.CZ	480.C.CZ
Pino	Pine	432.C.PN	434.C.PN	485.C.PN	480.C.PN
Haya Blanca	Beech Tree	432.C.Y	434.C.Y	-	480.C.Y
Haya Vaporizada	Steam Beech	432.C.YV	434.C.YV	485.C.YV	480.C.YV
VINILO	VINYL	REF.	REF.	REF.	REF.
Blanco Sil	Blanco Sil	432.V.BS	434.V.BS	-	480.V.BS
Blanco Perla Touch	Blanco Perla Touch	432.V.BP	434.V.BP	-	480.V.BP
Blanco RAL 9003	Blanco RAL 9003	432.V.9003	434.V.9003	-	480.V.9003
Halifax Natural	Natural Halifax	432.V.HN	434.V.HN	-	480.V.HN
Halifax Tabaco	Tabaco Halifax	432.V.HT	434.V.HT	-	480.V.HT
Halifax Blanco	White Halifax	432.V.HB	434.V.HB	-	480.V.HB
Wengue Duero	Wengue Duero	432.V.W	434.V.W	-	480.V.W
Palo Rosa Touch	Palo Rosa Touch	432.V.PRT	434.V.PRT	-	480.V.PRT

INSTRUCCIONES DE MONTAJE

ASSEMBLY INSTRUCTIONS

BATIENTE 70x12
(REF 480)



BATIENTE 105x16
(REF 485)

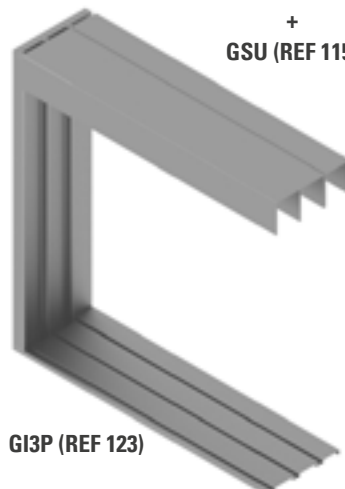

GSO (REF 112)
+
GSU (REF 115)

TAPETA 70x11
(REF 432)

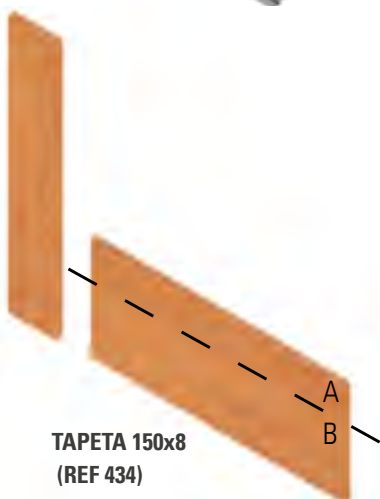

TAPETA 70x11
(REF 432)

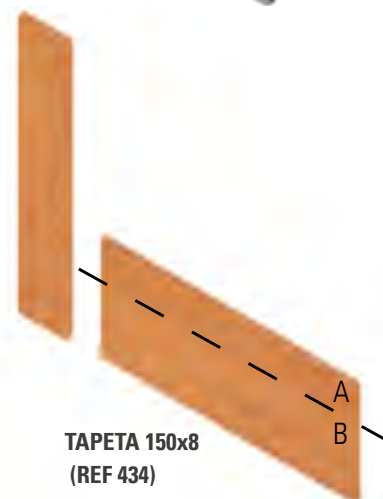

TAPETA 150x8
(REF 434)

TAPETA 150x8
(REF 434)

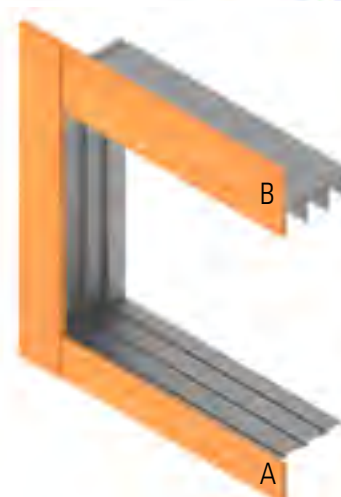
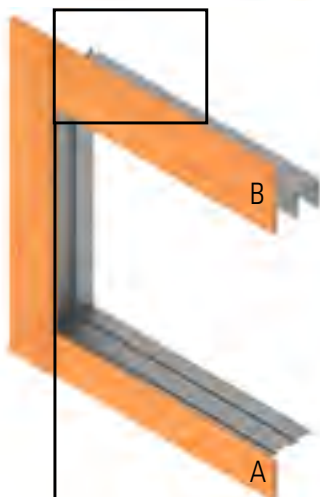

70mm

KIT PUERTAS

SLIDING DOOR KIT

ADINOR

CONTENIDO DEL KIT

KIT ELEMENTS

Rueda Inferior con Rodamiento
Lower Roller with Bearings



x2

Tirador de Hoja
Handle Profile

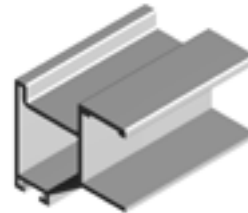

x2

Bolsa Cepillo
Brush Bag



x1

Cuña de Freno
Upper Stopper



x1

Caballote metálico con goma y cojinetes
Metallic Upper Roller with Bearings



x2

Perfil Embellecedor U
U Profile

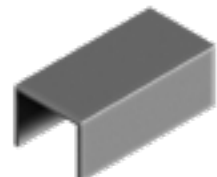

x1



KIT
RT16mm.

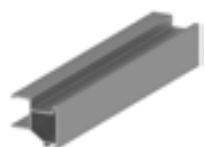

KIT
RT16mm.

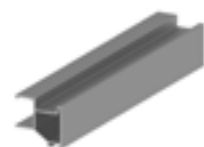

RR QUILLA

Ref. 177
2 und



RR ACANALADA

Ref. 176
2 und



RDO ACANALADO

Ref. 173
2 und



RR QUILLA

Ref. 177
2 und



ACABADOS

FINISHINGS

LACADOS	COATED	REF.	REF.	REF.	REF.
Blanco Brillo Ral 9010	White	945.B.L.B	945.C.L.B	945.D.L.B	945.B.L.B.25
Blanco Mate Ral 9003	Mat white	945.B.L.BM03	945.C.L.BM03	945.D.L.BM03	-
Blanco Mate Ral 9010	Mat white	945.B.L.BM	945.C.L.BM	945.D.L.BM	-
Negro Mate	Mat Black	945.B.L.NM	945.C.L.NM	945.D.L.NM	-
Antracita	Anthracite	945.B.L.ANT	945.C.L.ANT	945.D.L.ANT	-
Oro	Gold	945.B.L.O	945.C.L.O	945.D.L.O	-
ANODIZADOS	ANODIZED	REF.	REF.	REF.	REF.
Bronce Brillo Repulido	Bronce	945.B.A.BR	945.C.A.BR	945.D.A.BR	-
Plata Brillo Repulido	Polished Silver	945.B.A.P	945.C.A.P	945.D.A.P	-
Plata Mate	Natural Anodized	945.B.A.PM	945.C.A.PM	945.D.A.PM	945.B.A.PM.25
Inox Brillo Repulido	Inox	945.B.A.X	945.C.A.X	945.D.A.X	-
MELAMINA	MELAMINE	REF.	REF.	REF.	REF.
Roble RO 444	Oak	945.B.M.RBRO	945.C.M.RBRO	945.D.M.RBRO	945.B.M.RB.25
Roble A0562	Oak A0562	945.B.M.RB562	945.C.M.RB562	945.D.M.RB562	-
Sapely D2517	Sapely	945.B.M.SPD	945.C.M.SPD	945.D.M.SPD	-
Cerezo Duero	Cherry Tree	945.B.M.CZD	945.C.M.CZD	945.D.M.CZD	-
Cerezo Tajo	Cherry Tree	945.B.M.CZT	945.C.M.CZT	945.D.M.CZT	-
Haya Blanca Almijara	Beech Tree	945.B.M.Y	945.C.M.Y	945.D.M.Y	-
Haya Vapor. 428	Steam Beech	945.B.M.YV	945.C.M.YV	945.D.M.YV	-
Wengue Congo	Wengue	945.B.M.W	945.C.M.W	945.D.M.W	-
Blanco Rebornizable	White	945.B.M.MR	945.C.M.MR	945.D.M.MR	-
Textil Cancun	Textil Cancun	945.B.M.TXCANC	945.C.M.TXCANC	945.D.M.TXCANC	-
MADERA	NATURAL WOOD	REF.	REF.	REF.	REF.
Roble Francés	Oak	945.B.C.RB	945.C.C.RB	945.D.C.RB	-
Sapely	Sapely	945.B.C.SP	945.C.C.SP	945.D.C.SP	-
Cerezo	Cherry Tree	945.B.C.CZ	945.C.C.CZ	945.D.C.CZ	-
Pino	Pine	945.B.C.PN	945.C.C.PN	945.D.C.PN	-
Haya Blanca	Beech Tree	945.B.C.Y	945.C.C.Y	945.D.C.Y	-
Haya Vaporizada	Steam Beech	945.B.C.YV	945.C.C.YV	945.D.C.YV	-
VINILO	VINYL	REF.	REF.	REF.	REF.
Blanco Sil	Blanco Sil	945.B.V.BS	945.C.V.BS	945.D.V.BS	-
Blanco Perla Touch	Blanco Perla T.	945.B.V.BP	945.C.V.BP	945.D.V.BP	-
Blanco RAL 9003	Blanco RAL 9003	945.B.V.9003	945.C.V.9003	945.D.V.9003	-
Halifax Natural	Halifax Natural	945.B.V.HN	945.C.V.HN	945.D.V.HN	-
Halifax Tabaco	Halifax Tabaco	945.B.V.HT	945.C.V.HT	945.D.V.HT	-
Halifax Blanco	Halifax White	945.B.V.HB	945.C.V.HB	945.D.V.HB	-
Wengue Duero	Wengue Duero	945.B.V.W	945.C.V.W	945.D.V.W	-
Palo Rosa Touch	Palo Rosa T.	945.B.V.PRT	945.C.V.PRT	945.D.V.PRT	-

70mm

KIT PUERTAS SLIDING DOOR KIT

ADINOR

KIT
F016mm.

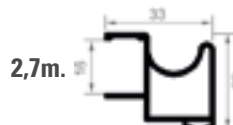

KIT
F016mm.

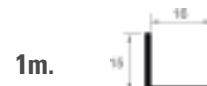
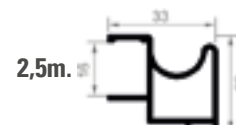

ACABADOS	FINISHINGS	RR QUILLA Ref. 177 2 und	RR ACANALADA Ref. 176 2 und	RDO ACANALADO Ref. 173 2 und	RR QUILLA Ref. 177 2 und
LACADOS	COATED	REF.	REF.	REF.	REF.
Blanco Brillo Ral 9010	White	940.B.L.B	940.C.L.B	940.D.L.B	940.B.L.B.25
Blanco Mate Ral 9010	Mat white	940.B.L.BM	940.C.L.BM	940.D.L.BM	-
Blanco Mate Ral 9003	Mat white	940.B.L.BM03	940.C.L.BM03	940.D.L.BM03	-
Negro Mate	Mat black	940.B.L.NM	940.C.L.NM	940.D.L.NM	-
Antracita	Anthracite	940.B.L.ANT	940.C.L.ANT	940.D.L.ANT	-
Oro	Gold	940.B.L.O	940.C.L.O	940.D.L.O	-
ANODIZADOS	ANODIZED	REF.	REF.	REF.	REF.
Bronce Brillo Repulido	Bronce	940.B.A.BR	940.C.A.BR	940.D.A.BR	-
Plata Mate	Natural Anodized	940.B.A.PM	940.C.A.PM	940.D.A.PM	940.B.A.PM.25
Inox Brillo Repulido	Inox	940.B.A.X	940.C.A.X	940.D.A.X	-
MELAMINA	MELAMINE	REF.	REF.	REF.	REF.
Roble RO 444	Oak	940.B.M.RBRO	940.C.M.RBRO	940.D.M.RBRO	940.B.M.RB.25
Roble 562	Oak	940.B.M.RB562	940.C.M.RB562	940.D.M.RB562	-
Sapely D2517	Sapely	940.B.M.SPD	940.C.M.SPD	940.D.M.SPD	-
Cerezo Duero	Cherry Tree	940.B.M.CZD	940.C.M.CZD	940.D.M.CZD	-
Cerezo Tajo	Cherry Tree	940.B.M.CZT	940.C.M.CZT	940.D.M.CZT	-
Haya Blanca Almijara	Beech Tree	940.B.M.Y	940.C.M.Y	940.D.M.Y	-
Haya Vapor. 428	Steam Beech	940.B.M.YV	940.C.M.YV	940.D.M.YV	-
Wengue Congo	Wengue	940.B.M.W	940.C.M.W	940.D.M.W	-
Blanco Rebornizable	White	940.B.M.MR	940.C.M.MR	940.D.M.MR	-
Nogal Montisa	Montisa Walnut	940.B.M.MNT	940.C.M.MNT	940.D.M.MNT	-
MADERA	NATURAL WOOD	REF.	REF.	REF.	REF.
Roble Francés	Oak	940.B.C.RB	940.C.C.RB	940.D.C.RB	-
Sapely	Sapely	940.B.C.SP	940.C.C.SP	940.D.C.SP	-
Cerezo	Cherry Tree	940.B.C.CZ	940.C.C.CZ	940.D.C.CZ	-
Pino	Pine	940.B.C.PN	940.C.C.PN	940.D.C.PN	-
Haya Blanca	Beech Tree	940.B.C.Y	940.C.C.Y	940.D.C.Y	-
Haya Vaporizada	Steam Beech	940.B.C.YV	940.C.C.YV	940.D.C.YV	-

KIT
GT16mm.

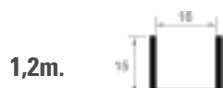
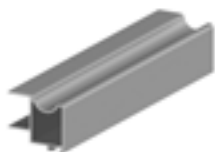

KIT
GT16mm.

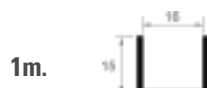
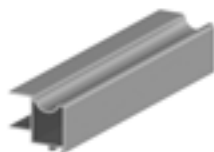

KIT
AEC16mm.



RR QUILLA Ref. 177 2 und	RR ACANALADA Ref. 176 2 und	RDO ACANALADO Ref. 173 2 und	RR QUILLA Ref. 177 2 und	RR QUILLA Ref. 177 2 und
REF.	REF.	REF.	REF.	REF.
949.B.L.B	949.C.L.B	949.D.L.B	949.B.L.B.25	-
-	-	-	-	-
949.B.L.BM03	949.C.L.BM03	-	-	-
949.B.L.NM	949.C.L.NM	-	-	-
-	-	-	-	-
-	-	-	-	-
REF.	REF.	REF.	REF.	REF.
-	-	-	-	-
949.B.A.PM	949.C.A.PM	949.D.A.PM	949.B.A.PM.25	9475.B.A.PM
-	-	-	-	-
REF.	REF.	REF.	REF.	REF.
949.B.M.RBRO	949.C.M.RBRO	949.D.M.RBRO	-	-
-	-	-	-	-
949.B.M.SPD	949.C.M.SPD	949.D.M.SPD	-	-
949.B.M.CZD	949.C.M.CZD	949.D.M.CZD	-	-
949.B.M.CZT	949.C.M.CZT	949.D.M.CZT	-	-
949.B.M.Y	949.C.M.Y	949.D.M.Y	-	-
949.B.M.YV	949.C.M.YV	949.D.M.YV	-	-
949.B.M.W	949.C.M.W	949.D.M.W	-	-
949.B.M.MR	949.C.M.MR	949.D.M.MR	-	-
-	-	-	-	-
REF.	REF.	REF.	REF.	REF.
949.B.C.RB	949.C.C.RB	949.D.C.RB	-	-
949.B.C.SP	949.C.C.SP	949.D.C.SP	-	-
949.B.C.CZ	949.C.C.CZ	949.D.C.CZ	-	-
949.B.C.PN	949.C.C.PN	949.D.C.PN	-	-
949.B.C.Y	949.C.C.Y	949.D.C.Y	-	-
949.B.C.YV	949.C.C.YV	949.D.C.YV	-	-

70mm

KIT PUERTAS SLIDING DOOR KIT

ADINOR

KIT
RT10mm.



2,7m.



1,2m.



KIT
RT10mm.



2,5m.

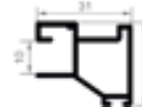

1m.



KIT
CRVO10mm.

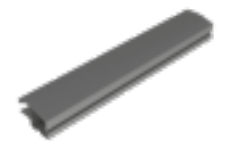

2,6m.



1,2m.



+ BAJO PEDIDO / UNDER REQUEST

ACABADOS	FINISHINGS	RR QUILLA Ref. 177 2 und	RR ACANALADA Ref. 176 2 und	RR QUILLA Ref. 177 2 und	RR QUILLA Ref. 177 2 und
LACADOS	COATED	REF.	REF.	REF.	REF.
Blanco Brillo Ral 9010	White	9451.B.L.B	9451.C.L.B	-	942.B.L.B
Negro Mate	Mat Black	9451.B.L.NM	9451.C.L.NM	-	-
Oro	Gold	9451.B.L.O	9451.C.L.O	-	-
ANODIZADOS	ANODIZED	REF.	REF.	REF.	REF.
Bronce Brillo Repulido	Bronce	9451.B.A.BR	9451.C.A.BR	-	-
Plata Brillo Repulido	Polished Silver	-	-	-	-
Plata Mate	Natural Anodized	9451.B.A.PM	9451.C.A.PM	9451.B.A.PM25	942.B.A.PM
Inox Brillo Repulido	Inox	9451.B.A.X	9451.C.A.X	-	-
MELAMINA	MELAMINE	REF.	REF.	REF.	REF.
Roble RO 444	Oak	9451.B.M.RBRO	9451.C.M.RBRO	-	942.B.M.RBRO
Roble 562	Oak	-	-	-	+ 942.B.M.RB562
Sapely D2517	Sapely	9451.B.M.SPD	9451.C.M.SPD	-	+ 942.B.M.SPD
Cerezo Duero	Cherry Tree	9451.B.M.CZD	9451.C.M.CZD	-	+ 942.B.M.CZD
Cerezo Tajo	Cherry Tree	9451.B.M.CZT	9451.B.M.CZT	-	+ -
Haya Blanca Almijara	Beech Tree	9451.B.M.Y	9451.C.M.Y	-	942.B.M.Y
Haya Vapor. 428	Steam Beech	9451.B.M.YV	9451.C.M.YV	-	+ 942.B.M.YV
Wengue Congo	Wengue	9451.B.M.W	9451.C.M.W	-	+ 942.B.M.W
Blanco Rebornizable	White	9451.B.M.MR	9451.C.M.MR	-	+ 942.B.M.MR
MADERA	NATURAL WOOD	REF.	REF.	REF.	+ REF.
Roble Francés	Oak	9451.B.C.RB	9451.C.C.RB	-	942.B.C.RB
Sapely	Sapely	9451.B.C.SP	9451.C.C.SP	-	+ 942.B.C.SP
Cerezo	Cherry Tree	9451.B.C.CZ	9451.C.C.CZ	-	+ 942.B.C.CZ
Pino	Pine	9451.B.C.PN	9451.C.C.PN	-	+ 942.B.C.PN
Haya Blanca	Beech Tree	9451.B.C.Y	9451.C.C.Y	-	+ 942.B.C.Y
Haya Vaporizada	Steam Beech	9451.B.C.YV	9451.C.C.YV	-	+ 942.B.C.YV
VINILO	VINYL	REF.	REF.	REF.	+ REF.
Blanco Sil	Blanco Sil	9451.B.V.BS	9451.C.V.BS	-	-
Blanco Perla Touch	Blanco Perla T.	9451.B.V.BP	9451.C.V.BP	-	-
Blanco RAL 9003	Blanco RAL 9003	9451.B.V.9003	9451.C.V.9003	-	-
Halifax Natural	Natural Halifax	9451.B.V.HN	9451.C.V.HN	-	-
Halifax Tabaco	Tabaco Halifax	9451.B.V.HT	9451.C.V.HT	-	-
Halifax Blanco	White Halifax	9451.B.V.HB	9451.C.V.HB	-	-
Wengue Duero	Wengue Duero	9451.B.V.VW	9451.C.V.VW	-	-
Palo Rosa Touch	Palo Rosa T.	9451.B.V.PRT	9451.C.V.PRT	-	-

KIT
F010mm.



2,7m.



KIT
F010mm.



2,5m.



KIT
JP10mm.

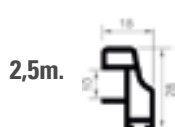

2,5m.



KIT
MIN10mm.

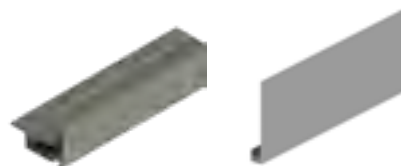

2,7m.



1,2m.



RR QUILLA
Ref. 177
2 und



REF.

943.B.L.B

943.B.L.NM

943.B.L.O

REF.

943.B.A.BR

943.B.A.PM

943.B.A.X

REF.

943.B.M.RBRO

943.B.M.SPD

943.B.M.CZD



943.B.M.Y

943.B.M.YV

943.B.M.W

943.B.M.MR

REF.

943.B.C.RB

943.B.C.SP

943.B.C.CZ

943.B.C.PN

943.B.C.Y

943.B.C.YV

RR
ACANALADA
Ref. 176
2 und



REF.

943.C.L.B

943.C.L.NM

943.C.L.O

REF.

943.C.A.BR

943.C.A.PM

943.C.A.X

REF.

943.C.M.RBRO

943.C.M.SPD

943.C.M.CZD



943.C.M.Y

943.C.M.YV

943.C.M.W

943.C.M.MR

REF.

943.C.C.RB

943.C.C.SP

943.C.C.CZ

943.C.C.PN

943.C.C.Y

943.C.C.YV

RR QUILLA
Ref. 177
2 und



REF.

943.B.L.B.25

-

-

REF.

-

943.B.A.PM25

-

REF.

-

-

-

-

-

-

-

-

REF.

-

-

-

-

-

-

RR QUILLA
Ref. 177
2 und



REF.

941.B.L.B

-

-

REF.

-

941.B.A.P

941.B.A.PM

-

REF.

-

-

-

-

-

-

-

-

REF.

-

-

-

-

-

-

RR QUILLA
Ref. 177
2 und



REF.

947.B.L.B

947.B.L.NM

-

REF.

-

947.B.A.P

947.B.A.PM

-

REF.

947.B.M.RBRO

947.B.M.RB562

-

-

-

-

947.B.M.YV

947.B.M.W

947.B.M.MR

REF.

947.B.C.RB

947.B.C.SP

947.B.C.CZ

947.B.C.PN

947.B.C.Y

-

70mm

KIT PUERTAS SLIDING DOOR KIT

ADINOR

KIT
EX10mm.

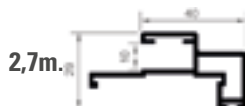
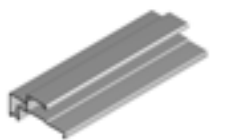

1,2m.



KIT
HE10mm.

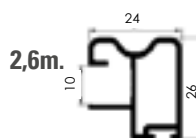

1,2m.



KIT
R018mm.

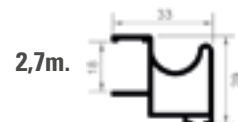

1,2m.



KIT
AEC18mm.



1m.

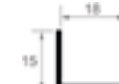

+ BAJO PEDIDO / UNDER REQUEST

ACABADOS	FINISHINGS	EX Ref. 178 2 und	RR QUILLA Ref. 177 2 und	R10 Ref. 179 2 und	R10 Ref. 179 2 und
LACADOS	COATED	REF.	REF.	REF.	REF.
Blanco Brillo Ral 9010	White	9497.B.L.B	9438.B.L.B	9481.B.L.B	-
Blanco Mate 9003	Mat White Ral9003	-	-	9481.B.L.BM03	-
Negro Mate	Mat black	-	-	9481.B.L.NM	-
Antracita	Anthracite	-	-	9481.B.L.ANT	-
ANODIZADOS	ANODIZED	REF.	REF.	REF.	REF.
Bronce Brillo Repulido	Bronce	-	-	9481.B.A.BR	-
Plata Brillo Repulido	Polished Silver	-	-	-	-
Plata Mate	Natural Anodized	9497.B.A.PM	9438.B.A.PM	9481.B.A.PM	9478.B.A.PM
Inox Brillo Repulido	Inox	-	-	9481.B.A.X	-
MELAMINA	MELAMINE	REF.	REF.	REF.	REF.
Roble RO 444	Oak	-	-	9481.B.M.RBRO	-
Sapely D2517	Sapely	-	-	-	-
Cerezo Duero	Cherry Tree	+ 9497.B.M.CZD	-	-	-
Cerezo Tajo	Cherry Tree	+ 9497.B.M.CZT	-	-	-
Haya Blanca Almijara	Beech Tree	+ 9497.B.M.Y	-	-	-
Haya Vapor. 428	Steam Beech	-	-	-	-
Wengue Congo	Wengue	+ 9497.B.M.W	-	-	-
Blanco Rebornizable	White	+ 9497.B.M.MR	-	-	-
MADERA	NATURAL WOOD	REF.	REF.	REF.	REF.
Roble Francés	Oak	+ 9497.B.C.RB	-	9481.B.C.RB	-
Sapely	Sapely	+ 9497.B.C.SP	-	-	-
Cerezo	Cherry Tree	+ 9497.B.C.CZ	-	-	-
Pino	Pine	+ 9497.B.C.PN	-	-	-
Haya Blanca	Beech Tree	+ 9497.B.C.Y	-	-	-
Haya Vaporizada	Steam Beech	+ 9497.B.C.YV	-	-	-

KIT
R018-10mm.

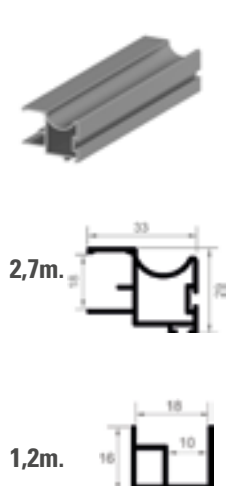

KIT
RT18mm.

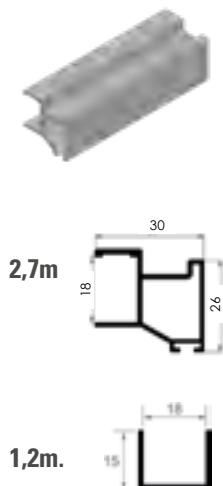

KIT
RT19mm.

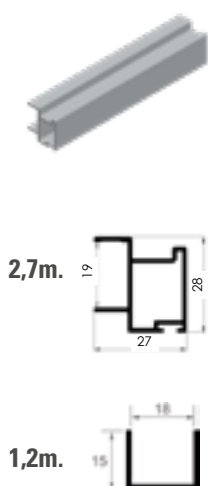

KIT
BT10mm.

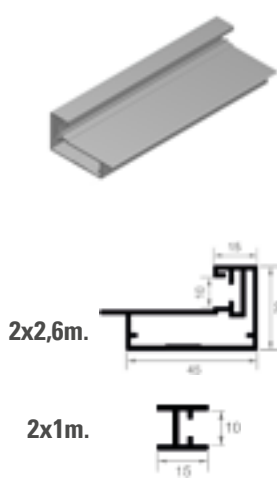

2un.



2un.



6un.



4un.



R10 Ref. 179 2 und	
---------------------------------	--

REF.
-
-
-
-
-
REF.
-
-
9489.B.A.PM
-

R10 Ref. 179 2 und	
---------------------------------	--

REF.
-
9404.B.L.BM03
9404.B.L.NM
9404.B.L.ANT
-
REF.
9404.B.A.BR
-
9404.B.A.PM
9404.B.A.X

R10 Ref. 179 2 und	
---------------------------------	--

REF.
9428.B.L.B
-
9428.B.L.NM
-
-
REF.
-
-
9428.B.A.PM
-

RR QUILLA Ref. 177 2 und	
---------------------------------------	--

REF.
BTK.B.L.B
-
BTK.B.L.NM
-
-
REF.
-
BTK.B.A.P
BTK.B.A.PM
-



70mm KIT GUÍAS TRACKS KIT

ADINOR

GSO-GI70

KIT GUÍA
TRACKS KIT

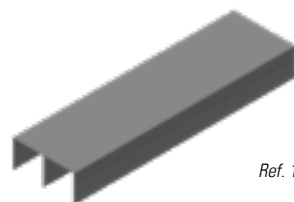

Ref. 112



Ref. 139



Ref. 196

ACABADOS	FINISHINGS	1,5 m.	2 m.	3 m.	4 m.
LACADOS	COATED	REF.	REF.	REF.	REF.
Blanco Brillo Ral 9010	White	980.L.B.1.5	980.L.B.2	980.L.B.3	980.L.B.4
Blanco Mate Ral 9010	Mat white	980.L.BM.1.5	980.L.BM.2	980.L.BM.3	980.L.BM.4
Blanco Mate Ral 9003	Mat white	980.L.BM03.1.5	980.L.BM03.2	980.L.BM03.3	980.L.BM03.4
Negro Mate	Mat black	980.L.NM.1.5	980.L.NM.2	980.L.NM.3	980.L.NM.4
Antracita	Anthracite	980.L.ANT.1.5	980.L.ANT.2	980.L.ANT.3	980.L.ANT.4
Oro	Gold	980.L.O.1.5	980.L.O.2	980.L.O.3	980.L.O.4
ANODIZADOS	ANODIZED	REF.	REF.	REF.	REF.
Bronce Brillo Repulido	Bronce	980.A.BR.1.5	980.A.BR.2	980.A.BR.3	980.A.BR.4
Plata Brillo Repulido	Polished Silver	980.A.P.1.5	980.A.P.2	980.A.P.3	980.A.P.4
Plata Mate	Natural Anodized	980.A.PM.1.5	980.A.PM.2	980.A.PM.3	980.A.PM.4
Inox Brillo Repulido	Inox	980.A.X.1.5	980.A.X.2	980.A.X.3	980.A.X.4
MELAMINA	MELAMINE	REF.	REF.	REF.	REF.
Roble RO 444	Oak	980.M.RBRO.1.5	980.M.RBRO.2	980.M.RBRO.3	980.M.RBRO.4
Roble A0562	Oak A0562	980.M.RB562.1.5	980.M.RB562.2	980.M.RB562.3	980.M.RB562.4
Sapely D2517	Sapely	980.M.SPD.1.5	980.M.SPD.2	980.M.SPD.3	980.M.SPD.4
Cerezo Duero	Cherry Tree	980.M.CZD.1.5	980.M.CZD.2	980.M.CZD.3	980.M.CZD.4
Cerezo Tajo	Cherry Tree	980.M.CZT.1.5	980.M.CZT.2	980.M.CZT.3	980.M.CZT.4
Haya Blanca Almijara	Beech Tree	980.M.Y.1.5	980.M.Y.2	980.M.Y.3	980.M.Y.4
Haya Vapor. 428	Steam Beech	980.M.YV.1.5	980.M.YV.2	980.M.YV.3	980.M.YV.4
Wengue Congo	Wengue	980.M.W.1.5	980.M.W.2	980.M.W.3	980.M.W.4
Blanco Rebornizable	White	980.M.MR.1.5	980.M.MR.2	980.M.MR.3	980.M.MR.4
Nogal Montisa	Montisa Walnut	980.M.NG.1.5	980.M.NG.2	980.M.NG.3	980.M.NG.4
Textil Cancun	Textil Cancun	980.M.TXCANC.15	980.M.TXCANC.2	980.M.TXCANC.3	980.M.TXCANC.4
MADERA	NATURAL WOOD	REF.	REF.	REF.	REF.
Roble Francés	Oak	980.C.RB.1.5	980.C.RB.2	980.C.RB.3	980.C.RB.4
Sapely	Sapely	980.C.SP.1.5	980.C.SP.2	980.C.SP.3	980.C.SP.4
Cerezo	Cherry Tree	980.C.CZ.1.5	980.C.CZ.2	980.C.CZ.3	980.C.CZ.4
Pino	Pine	980.C.PN.1.5	980.C.PN.2	980.C.PN.3	980.C.PN.4
Haya Blanca	Beech Tree	980.C.Y.1.5	980.C.Y.2	980.C.Y.3	980.C.Y.4
Haya Vaporizada	Steam Beech	980.C.YV.1.5	980.C.YV.2	980.C.YV.3	980.C.YV.4
VINILO	VINYL	REF.	REF.	REF.	REF.
Blanco Sil	Blanco Sil	980.V.BS.1.5	980.V.BS.2	980.V.BS.3	980.V.BS.4
Blanco Perla Touch	Blanco Perla T.	980.V.BP.1.5	980.V.BP.2	980.V.BP.3	980.V.BP.4
Blanco RAL 9003	Blanco RAL 9003	980.V.9003.15	980.V.9003.2	980.V.9003.3	980.V.9003.4
Halifax Natural	Natural Halifax	980.V.HN.1.5	980.V.HN.2	980.V.HN.3	980.V.HN.4
Halifax Tabaco	Tabaco Halifax	980.V.HT.1.5	980.V.HT.2	980.V.HT.3	980.V.HT.4
Halifax Blanco	White Halifax	980.V.HB.1.5	980.V.HB.2	980.V.HB.3	980.V.HB.4
Wengue Duero	Wengue Duero	980.V.W.1.5	980.V.W.2	980.V.W.3	980.V.W.4
Palo Rosa Touch	Palo Rosa T.	980.V.PRT.1.5	980.V.PRT.2	980.V.PRT.3	980.V.PRT.4

GSEC-GI70

KIT GUÍA
TRACKS KIT

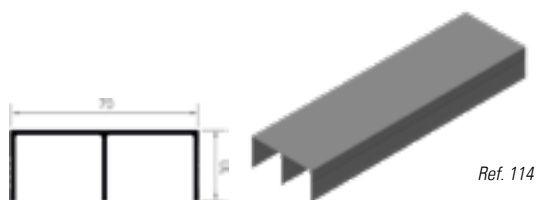

Ref. 114

GSO-GI0

KIT GUÍA
TRACKS KIT



Ref. 112



Ref. 196



Ref. 139



Ref. 135

2 m.	3 m.	4 m.
REF.	REF.	REF.
985.L.B.2	985.L.B.3	985.L.B.4
-	-	-
-	-	-
-	-	-
REF.	REF.	REF.
-	-	-
-	-	-
985.A.PM.2	985.A.PM.3	985.A.PM.4
-	-	-
REF.	REF.	REF.
-	-	-
-	-	-
-	-	-
-	-	-
-	-	-
-	-	-
-	-	-
-	-	-
-	-	-
-	-	-
-	-	-
REF.	REF.	REF.
-	-	-
-	-	-
-	-	-
-	-	-
-	-	-
-	-	-
-	-	-
-	-	-
-	-	-

2 m.	3 m.	4 m.
REF.	REF.	REF.
950.L.B.2	950.L.B.3	950.L.B.4
-	-	-
-	-	-
950.L.NM.2	950.L.NM.3	950.L.NM.4
950.L.ANT.2	950.L.ANT.3	950.L.ANT.4
-	-	-
REF.	REF.	REF.
950.A.BR.2	950.A.BR.3	950.A.BR.4
-	-	-
950.A.PM.2	950.A.PM.3	950.A.PM.4
950.A.X.2	950.A.X.3	950.A.X.4
REF.	REF.	REF.
950.M.RBRO.2	950.M.RBRO.3	950.M.RBRO.4
-	-	-
950.M.SPD.2	950.M.SPD.3	950.M.SPD.4
950.M.CZD.2	950.M.CZD.3	950.M.CZD.4
950.M.CZT.2	950.M.CZT.3	950.M.CZT.4
950.M.Y.2	950.M.Y.3	950.M.Y.4
950.M.YV.2	950.M.YV.3	950.M.YV.4
950.M.W.2	950.M.W.3	950.M.W.4
950.M.MR.2	950.M.MR.3	950.M.MR.4
-	-	-
-	-	-
REF.	REF.	REF.
950.C.RB.2	950.C.RB.3	950.C.RB.4
950.C.SP.2	950.C.SP.3	950.C.SP.4
950.C.CZ.2	950.C.CZ.3	950.C.CZ.4
950.C.PN.2	950.C.PN.3	950.C.PN.4
950.C.Y.2	950.C.Y.3	950.C.Y.4
950.C.YV.2	950.C.YV.3	950.C.YV.4

70mm

KIT GUÍAS

TRACKS KIT

ADINOR

GSO-GICO

KIT GUÍA
TRACKS KIT

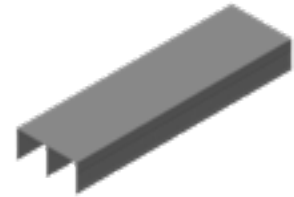

Ref. 112

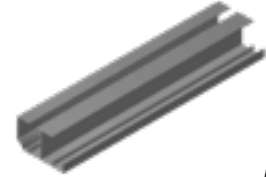
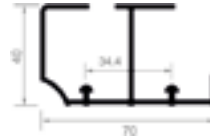

Ref. 138

BAJO PEDIDO / UNDER REQUEST

ACABADOS	FINISHINGS	2 m.	3 m.	4 m.
LACADOS	COATED	REF.	REF.	REF.
Blanco Brillo Ral 9010	White	970.L.B.2	970.L.B.3	970.L.B.4
Negro Mate	Mat Black	-	-	-
Oro	Gold	-	-	-
ANODIZADOS	ANODIZED	REF.	REF.	REF.
Bronce Brillo Repulido	Bronce	-	-	-
Plata Mate	Natural Anodized	970.A.PM.2	970.A.PM.3	970.A.PM.4
Inox Brillo Repulido	Inox	-	-	-
MELAMINA	MELAMINE	REF.	REF.	REF.
Roble RO 444	Oak	970.M.RBRO.2	970.M.RBRO.3	970.M.RBRO.4
Sapely D2517	Sapely	+ 970.M.SPD.2	+ 970.M.SPD.3	+ 970.M.SPD.4
Cerezo Duero	Cherry Tree	+ 970.M.CZD.2	+ 970.M.CZD.3	+ 970.M.CZD.4
Cerezo Tajo	Cherry Tree	-	-	-
Haya Blanca Almijara	Beech Tree	+ 970.M.Y.2	+ 970.M.Y.3	+ 970.M.Y.4
Haya Vapor. 428	Steam Beech	-	-	-
Wengue Congo	Wengue	-	-	-
Blanco Rebornizable	White	970.M.MR.2	970.M.MR.3	970.M.MR.4
MADERA	NATURAL WOOD	REF.	REF.	REF.
Roble Francés	Oak	970.C.RB.2	970.C.RB.3	970.C.RB.4
Sapely	Sapely	970.C.SP.2	970.C.SP.3	970.C.SP.4
Cerezo	Cherry Tree	970.C.CZ.2	970.C.CZ.3	970.C.CZ.4
Pino	Pine	970.C.PN.2	970.C.PN.3	970.C.PN.4
Haya Blanca	Beech Tree	970.C.Y.2	970.C.Y.3	970.C.Y.4
Haya Vaporizada	Steam Beech	970.C.YV.2	970.C.YV.3	970.C.YV.4

GSO-GI20

KIT GUÍA
TRACKS KIT

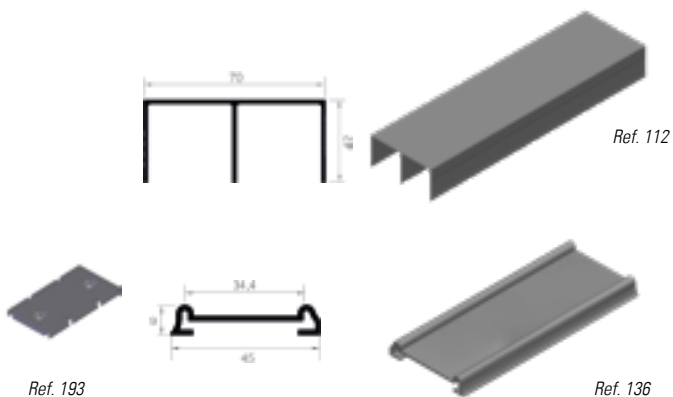

GSO-GSU-GI3P

KIT GUÍA
TRACKS KIT

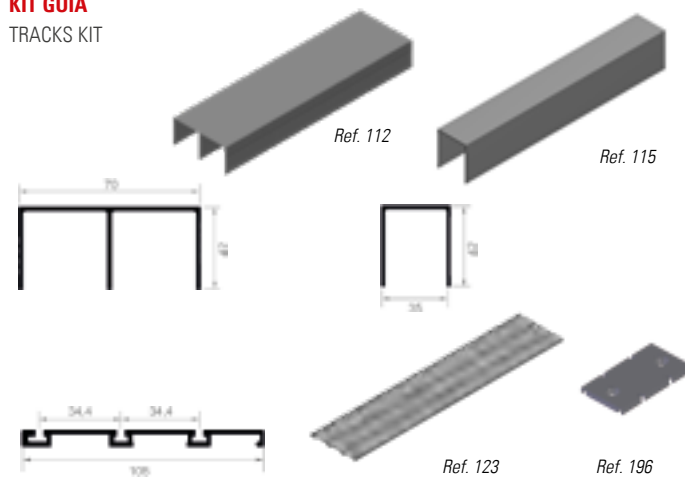

2 m.	3 m.	4 m.	2 m.	3 m.	4 m.
REF.	REF.	REF.	REF.	REF.	REF.
960.L.B.2	960.L.B.3	960.L.B.4	990.L.B.2	990.L.B.3	990.L.B.4
960.L.NM.2	960.L.NM.3	960.L.NM.4	990.L.NM.2	990.L.NM.3	990.L.NM.4
960.L.O.2	960.L.O.3	960.L.O.4	-	-	-
REF.	REF.	REF.	REF.	REF.	REF.
960.A.BR.2	960.A.BR.3	960.A.BR.4	-	-	-
960.A.PM.2	960.A.PM.3	960.A.PM.4	990.A.PM.2	990.A.PM.3	990.A.PM.4
960.A.X.2	960.A.X.3	960.A.X.4	-	-	-
REF.	REF.	REF.	REF.	REF.	REF.
960.M.RBRO.2	960.M.RBRO.3	960.M.RBRO.4	990.M.RBRO.2	990.M.RBRO.3	990.M.RBRO.4
960.M.SPD.2	960.M.SPD.3	960.M.SPD.4	-	-	-
960.M.CZD.2	960.M.CZD.3	960.M.CZD.4	-	-	-
960.M.CZT.2	960.M.CZT.3	960.M.CZT.4	-	-	-
960.M.Y.2	960.M.Y.3	960.M.Y.4	990.M.Y.2	990.M.Y.3	990.M.Y.4
960.M.YV.2	960.M.YV.3	960.M.YV.4	⊕ 990.M.YV.2	⊕ 990.M.YV.3	⊕ 990.M.YV.4
960.M.W.2	960.M.W.3	960.M.W.4	990.M.W.2	990.M.W.3	990.M.W.4
960.M.MR.2	960.M.MR.3	960.M.MR.4	990.M.MR.2	990.M.MR.3	990.M.MR.4
REF.	REF.	REF.	REF.	REF.	REF.
960.C.RB.2	960.C.RB.3	960.C.RB.4	990.C.RB.2	990.C.RB.3	990.C.RB.4
960.C.SP.2	960.C.SP.3	960.C.SP.4	-	-	-
960.C.CZ.2	960.C.CZ.3	960.C.CZ.4	990.C.CZ.2	990.C.CZ.3	990.C.CZ.4
960.C.PN.2	960.C.PN.3	960.C.PN.4	990.C.PN.2	990.C.PN.3	990.C.PN.4
960.C.Y.2	960.C.Y.3	960.C.Y.4	-	-	-
960.C.YV.2	960.C.YV.3	960.C.YV.4	990.C.YV.2	990.C.YV.3	990.C.YV.4

70mm

INSTRUCCIONES DE MONTAJE







ASSEMBLY INSTRUCTIONS

ADINOR

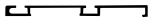
ALTURA PUERTA
DOOR HEIGHT

SIN AMORTIGUADOR
WITHOUT SELF CLOSING SYSTEM

CON AMORTIGUADOR
WITH SELF CLOSING SYSTEM

	GSO	GSEC	GSO
GI70 	H - 30		H - 40
GI3P 	H - 30		H - 40
GIO 	H - 30		H - 40
GIEC 	H - 30		H - 40
GI20 	H - 35		H - 45
GICO 	H - 65		H - 75

Para solape según dibujo esquema

Doors superposed according to drawing

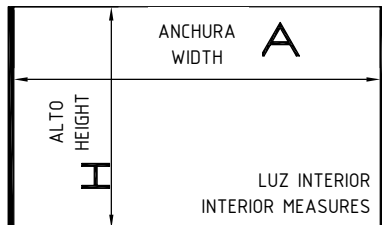

ACCEDE AL PROGRAMA DE DESPIECE DE CADA SERIE EN:



















www.adinor.info/programa-de-despiece

USE THE DOORS CUTTING SOFTWARE

ANCHURA DEL TABLERO / BOARD WIDTH (C)

		RT 16mm.	FO 16mm.	GT 16mm.	AEC 16mm.	GA 16mm.	RT 10mm.	FO 10mm.	CRVO 10mm.	JP 10mm.	MINVH 10mm.	RO 18-10mm.	RO 18mm.	AEC 18mm.	EX 10mm.	VHBT 10mm.
																
2 PUERTAS	2 BOARDS	A - 44 2	A - 50 2	A - 44 2	A - 28 2	A - 18 2	A - 44 2	A - 50 2	A - 65 2	A - 22 2	A - 8 2	A - 50 2	A - 50 2	A - 28 2	A - 39 2	A - 25 2
3 PUERTAS	3 BOARDS	A - 51 3	A - 60 3	A - 51 3	A - 30 3	A - 16 3	A - 51 3	A - 60 3	A - 76 3	A - 24 3	A - 4 3	A - 60 3	A - 60 3	A - 30 3	A - 39 3	A - 30 3
4 PUERTAS	4 BOARDS	A - 88 4	A - 100 4	A - 88 4	A - 56 4	A - 39 4	A - 88 4	A - 100 4	A - 130 4	A - 44 4	A - 16 4	A - 100 4	A - 100 4	A - 56 4	A - 78 4	A - 50 4
		HE 10mm.	JO 18mm.	RT 18mm.	RT 19mm.											
																
2 PUERTAS	2 BOARDS	A - 28 2	A - 50 2	A - 44 2	A - 41 2											
3 PUERTAS	3 BOARDS	A - 30 3	A - 60 3	A - 51 3	A - 48 3											
4 PUERTAS	4 BOARDS	A - 56 4	A - 100 4	A - 88 4	A - 82 4											

LONGITUD CORTE PERFIL H, U / H, U PROFILE HEIGHT

RT 16mm.	FO 16mm.	GT 16mm.	AEC 16mm.	RT 10mm.	FO 10mm.	CRVO 10mm.	JP 10mm.	MINVH 10mm.	RO 18-10mm.	RO 18mm.	AEC 18mm.	EX 10mm.	VHBT 10mm.	GA 16mm.	HE 10mm.
															
C - 23	C - 23	C - 23	C - 21	C - 23	C - 23	C - 31	C - 15	C - 13	C - 23	C - 23	C - 21	C - 39	C - 10	C - 23	C - 21
JO 18mm.	RT 18mm.	RT 19mm.													
															
C - 23	C - 23	C - 19													

SERIE 80

80 SERIE



80mm

ADINOR

GS80

GUÍA SUPERIOR GS80
GS80 UPPER RAIL

GS80 EC

GUÍA SUPERIOR GS80 EC
GS80 EC UPPER RAIL

GS80 3P

GUÍA SUPERIOR GS80 3P
GS80 3P UPPER RAIL

GI50

GUÍA INFERIOR GI50
GI50 LOWER RAIL

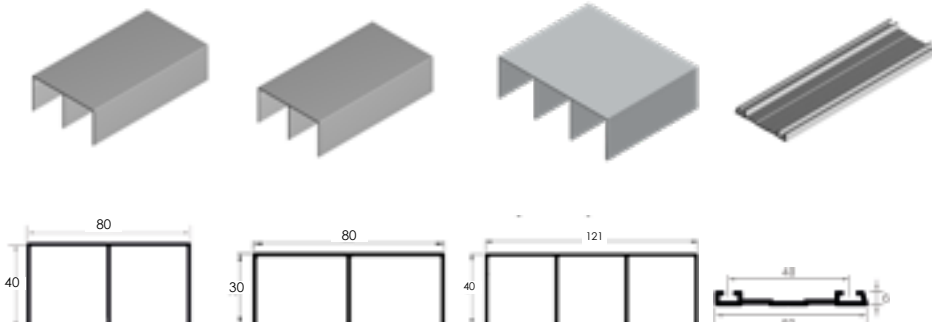

6m. Condiciones especiales de envío
6m. Special shipping conditions

ACABADOS	FINISHINGS	Longitud / Length : 6 m.	Longitud / Length : 6 m.	Longitud / Length : 6 m.	Longitud / Length : 6 m.
LACADOS	COATED	REF.	REF.	REF.	REF.
Blanco Brillo Ral 9010	White Ral 9010	117.L.B	1175.L.B	118.L.B	125.L.B
Blanco Mate Ral 9010	Mat white	117.L.BM	-	-	-
Blanco Mate Ral 9003	Mat White	117.L.BM03	-	-	-
Negro Mate	Mat Black	117.L.NM	-	-	-
Antracita	Anthracite	117.L.ANT	-	-	-
Oro	Gold	117.L.O	-	-	-
ANODIZADOS	ANODIZED	REF.	REF.	REF.	REF.
Bronce Brillo Repulido	Bronce	117.A.BR	-	-	-
Plata Brillo Repulido	Polished Silver	117.A.P	-	-	-
Plata Mate	Natural Anodized	117.A.PM	1175.A.PM	118.A.PM	125.A.PM
Inox Brillo Repulido	Inox	117.A.X	-	-	-
MELAMINA	MELAMINE	REF.	REF.	REF.	REF.
Textil Coral	Textil Coral	117.M.TXCO	-	-	-
Roble A-0562	Oak	117.M.RB562	-	-	-
Sapely D-2517	Sapely	117.M.SPD	-	-	-
Cerezo Duero	Cherry Tree	117.M.CZD	-	-	-
Cerezo Tajo	Cherry Tree	117.M.CZT	-	-	-
Haya Vaporizada 428	Steam Beech	117.M.YV	-	-	-
Blanco Rebornizable	White	117.M.MR	-	-	-
Wengue Congo	Wengue	117.M.W	-	-	-
MADERA	NATURAL WOOD	REF.	REF.	REF.	REF.
Roble Francés	Oak	117.C.RB	-	-	-
Sapely	Sapely	117.C.SP	-	-	-
Cerezo	Cherry Tree	117.C.CZ	-	-	-
Pino Gallego	Pine	117.C.PN	-	-	-
Haya Blanca	Beech Tree	117.C.Y	-	-	-
Haya Vapor	Steam Beech	117.C.YV	-	-	-
VINILO	VINYL	REF.	REF.	REF.	REF.
Blanco Sil	Blanco Sil	117.V.BS	-	-	-
Blanco RAL 9003	Blanco RAL 9003	117.V.9003	-	-	-
Blanco Perla Touch	Blanco Perla Touch	117.V.BP	-	-	-
Halifax Natural	Natural Halifax	117.V.HN	-	-	-
Halifax Tabaco	Tabaco Halifax	117.V.HT	-	-	-
Halifax Blanco	White Halifax	117.V.HB	-	-	-

GI80 3P

GUÍA INFERIOR GI80 3P
GI80 3P LOWER RAIL

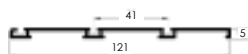

GI80

GUÍA INFERIOR GI80
GI80 LOWER RAIL



GI83

PERFIL INFERIOR GI83
GI83 LOWER RAIL

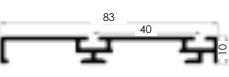

GI2A80

GUÍA INF. CERRADA GI2A80
GI2A80 LOWER RAIL

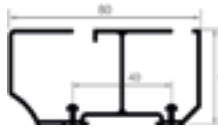
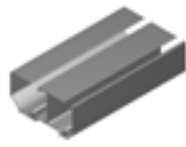

CTR60 10mm. H BT60

TIRADOR DE HOJA CTR60mm
CTR 60mm.
HANDLE PROFILE

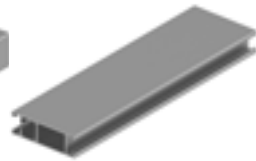
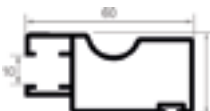
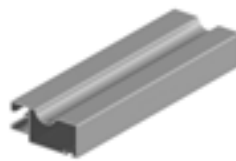

Longitud / Length : 6 m.	Longitud / Length : 6 m.	Longitud / Length : 6 m.	Longitud / Length : 6 m.	Longitud / Length : 2,7 m.	Longitud / Length : 3 m.
REF.	REF.	REF.	REF.	REF.	REF.
1295.L.B	126.L.B	128.L.B	127.L.B	-	-
-	126.L.BM	-	-	CTR110.L.BM	BT210.L.BM
-	126.L.BM03	128.L.BM03	-	-	-
-	126.L.NM	128.L.NM	127.L.NM	CTR110.L.NM	BT210.L.NM
-	126.L.ANT	-	-	-	-
-	126.L.O	-	-	-	-
REF.	REF.	REF.	REF.	REF.	REF.
-	126.A.BR	-	-	-	-
-	126.A.P	-	127.A.P	-	-
1295.A.PM	126.A.PM	128.A.PM	127.A.PM	CTR110.A.PM	BT210.A.PM
-	126.A.X	-	-	-	-
REF.	REF.	REF.	REF.	REF.	REF.
-	126.M.TXCO	-	-	CTR110.M.TXCO	BT210.M.TXCO
-	126.M.RB562	-	127.M.RB562	-	-
-	126.M.SPD	-	127.M.SPD	CTR110.M.SPD	BT210.M.SPD
-	126.M.CZD	-	127.M.CZD	-	-
-	126.M.CZT	-	-	-	-
-	126.M.YV	-	127.M.YV	CTR110.M.YV	BT210.M.YV
-	126.M.MR	-	127.M.MR	CTR110.M.MR	BT210.M.MR
-	126.M.W	-	-	-	-
REF.	REF.	REF.	REF.	REF.	REF.
-	126.C.RB	-	127.C.RB	CTR110.C.RB	BT210.C.RB
-	126.C.SP	-	127.C.SP	CTR110.C.SP	BT210.C.SP
-	126.C.CZ	-	127.C.CZ	CTR110.C.CZ	BT210.C.CZ
-	126.C.PN	-	127.C.PN	CTR110.C.PN	BT210.C.PN
-	126.C.Y	-	127.C.Y	CTR110.C.Y	BT210.C.Y
-	126.C.YV	-	127.C.YV	-	-
REF.	REF.	REF.	REF.	REF.	REF.
-	126.V.BS	-	-	-	-
-	126.V.9003	-	-	CTR110.V.9003	BT210.V.9003
-	126.V.BP	-	-	-	-
-	126.V.HN	-	-	-	-
-	126.V.HT	-	-	-	-
-	126.V.HB	-	-	-	-

80mm

ADINOR

6m. Condiciones especiales de envío
6m. Special shipping conditions

RTS10mm.

TIRADOR DE HOJA
RTS10mm.
RTS 10mm. HANDLE PROFILE

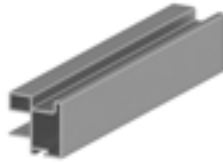

MINS10mm.

TIRADOR HOJA MINS10mm.
MINS10mm. HANDLE PROFILE

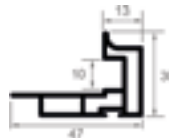

FALDÓN MIN10mm.

PERFIL FALDON SUP/INF
MIN 10mm. UPPER/LOWER
CONNECTION PROFILE

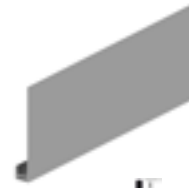

S016mm.

TIRADOR HOJA S016mm.
S016mm. HANDLE PROFILE



ACABADOS	FINISHINGS	Longitud / Length : 2,7 m.	Longitud / Length : 2,7 m.	Longitud / Length : 6 m.	Longitud / Length : 2,7 m.
LACADOS	COATED	REF.	REF.	REF.	REF.
Blanco Brillo Ral 9010	White Ral 9010	1410.L.B	C113.L.B	C210.L.B	1488.L.B
Blanco mate Ral 9010	Mate white	-	C113.L.BM	C210.L.BM	1488.L.BM
Blanco mate Ral 9003	Mat white	1410.L.BM03	C113.L.BM03	C210.L.BM03	-
Negro mate	Mate black	1410.L.NM	C113.L.NM	C210.L.NM	1488.L.NM
Antracita	Anthracite	-	-	-	1488.L.ANT
Oro	Gold	-	-	-	1488.L.O
ANODIZADOS	ANODIZED	REF.	REF.	REF.	REF.
Bronce Brillo Repulido	Bronce	-	-	-	1488.A.BR
Plata Brillo Repulido	Polished Silver	1410.A.P	C113.A.P	C210.A.P	1488.A.P
Plata Mate	Natural Anodized	1410.A.PM	C113.A.PM	C210.A.PM	1488.A.PM
Inox Brillo Repulido	Inox	-	-	-	-
MELAMINA	MELAMINE	REF.	REF.	REF.	REF.
Roble A-0562	A-0562 Oak	1410.M.RB562	C113.M.RB562	C210.M.RB562	1488.M.RB562
Textil Coral	Coral Textil	-	-	-	-
Sapely D2517	Sapely	1410.M.SPD	C113.M.SPD	C210.M.SPD	1488.M.SPD
Cerezo Duero	Cherry Tree	1410.M.CZD	C113.M.CZD	C210.M.CZD	1488.M.CZD
Cerezo Tajo	Cherry Tree	-	-	-	1488.M.CZT
Haya Vaporizada 428	Steam Beech	1410.M.YV	C113.M.YV	C210.M.YV	1488.M.YV
Blanco Rebornizable	White	1410.M.MR	C113.M.MR	C210.M.MR	1488.M.MR
MADERA	NATURAL WOOD	REF.	REF.	REF.	REF.
Roble Francés	Oak	1410.C.RB	C113.C.RB	C210.C.RB	1488.C.RB
Sapely	Sapely	1410.C.SP	C113.C.SP	C210.C.SP	1488.C.SP
Cerezo	Cherry Tree	1410.C.CZ	C113.C.CZ	C210.C.CZ	1488.C.CZ
Pino Gallego	Pine	1410.C.PN	C113.C.PN	C210.C.PN	1488.C.PN
Haya Blanca	Beech Tree	1410.C.Y	C113.C.Y	C210.C.Y	1488.C.Y
Haya Vapor	Steam Beech	-	-	-	1488.C.YV
VINILO	VINYL	REF.	REF.	REF.	REF.
Blanco RAL 9003	Blanco RAL 9003	1410.V.9003	-	-	1488.V.9003
Blanco Perla Touch	Touch Pearl white	-	-	-	-
Blanco Sil	Sil white	-	-	-	-
Halifax Natural	Natural Halifax	-	-	-	-
Halifax Tabaco	Tabaco Halifax	-	-	-	-
Halifax Blanco	White Halifax	-	-	-	-

RTS16mm.

TIRADOR HOJA RTS16mm.
RTS16mm.HANDLE PROFILE

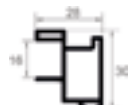

TZMS16mm.

TIRADOR DE HOJA
TZMS16mm.
TZMS 16mm. CT
HANDLE PROFILE



CT80 16mm.

TIRADOR DE HOJA
CT80 16mm.
16mm. CT80
HANDLE PROFILE

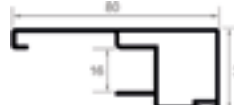
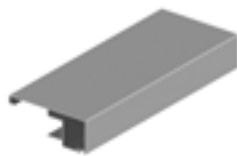

MINS16mm.

TIRADOR HOJA MINS16mm.
MINS16mm. HANDLE PROFILE

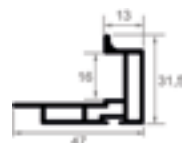
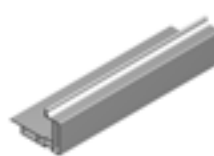

FALDÓN MIN16mm.

PERFIL FALDON SUP/INF
UPPER/LOWER
CONNECTION PROFILE



MSE16mm.

TIRADOR HOJA
MSE16mm.
MSE16mm. HANDLE PROFILE

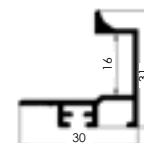

Longitud / Length : 2,7 m.	Longitud / Length : 2,7 m.	Longitud / Length : 2,7 m.	Longitud / Length : 2,7 m.	Longitud / Length : 6 m.	Longitud / Length : 2,6 m.
REF.	REF.	REF.	REF.	REF.	REF.
1496.L.B	1416.L.B	-	C123.L.B	C220.L.B	C124.L.B
1496.L.BM	1416.L.BM	-	C123.L.BM	C220.L.BM	-
1496.L.BM03	-	-	C123.L.BM03	C220.L.BM03	-
1496.L.NM	1416.L.NM	-	C123.L.NM	C220.L.NM	-
1496.L.ANT	-	-	C123.L.ANT	C220.L.ANT	-
-	-	-	-	-	-
REF.	REF.	REF.	REF.	REF.	REF.
-	-	-	-	-	-
1496.A.P	1416.A.P	-	C123.A.P	C220.A.P	-
1496.A.PM	1416.A.PM	-	C123.A.PM	C220.A.PM	C124.A.PM
1496.A.X	-	-	C123.A.X	C220.A.X	-
REF.	REF.	REF.	REF.	REF.	REF.
1496.M.RB562	1416.M.RB562	-	C123.M.RB562	C220.M.RB562	-
-	-	-	-	-	-
1496.M.SPD	1416.M.SPD	-	C123.M.SPD	C220.M.SPD	-
1496.M.CZD	1416.M.CZD	-	-	-	-
-	-	-	-	-	-
1496.M.YV	1416.M.YV	-	-	-	-
1496.M.MR	1416.M.MR	140.M.MR	C123.M.MR	C220.M.MR	C124.M.MR
REF.	REF.	REF.	REF.	REF.	REF.
1496.C.RB	1416.C.RB	140.C.RB	C123.C.RB	C220.C.RB	-
1496.C.SP	1416.C.SP	140.C.SP	C123.C.SP	C220.C.SP	-
1496.C.CZ	1416.C.CZ	140.C.CZ	C123.C.CZ	C220.C.CZ	-
1496.C.PN	1416.C.PN	140.C.PN	C123.C.PN	C220.C.PN	-
1496.C.Y	1416.C.Y	140.C.Y	C123.C.Y	C220.C.Y	-
1496.C.YV	-	-	C123.C.YV	C220.C.YV	-
REF.	REF.	REF.	REF.	REF.	REF.
1496.V.9003	-	140.V.9003	-	-	C124.V.9003
-	-	140.V.BP	-	-	-
1496.V.BS	-	-	-	-	-
1496.V.HN	-	-	-	-	-
1496.V.HT	-	-	-	-	-
1496.HB	-	-	-	-	-

RTS19mm.

TIRADOR HOJA
RTS19mm.
RTS19mm. HANDLE
PROFILE

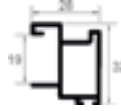

MINS19mm.

TIRADOR DE HOJA
MINS19mm.
MINS19mm.
HANDLE PROFILE



PS19mm.

TIRADOR DE HOJA
PS19mm.
PS19mm.
HANDLE PROFILE

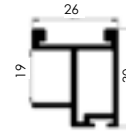
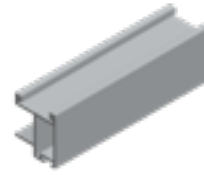

RTCS19mm.

TIRADOR DE HOJA
RTCS 19mm.
PS19mm.
HANDLE PROFILE

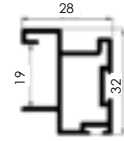

ACABADOS	FINISHINGS	Longitud / Length : 2,7m.	Longitud / Length : 2,7 m.	Longitud / Length : 2,6 m.	Longitud / Length : 3 m.
LACADOS	COATED	REF.	REF.	REF.	REF.
Blanco Brillo Ral 9010	White Ral 9010	1418.L.B	C133.L.B	-	14181.L.B
Blanco mate Ral 9010	Mate white	1418.L.BM	-	-	-
Blanco mate Ral 9003		1418.L.BM03	C133.L.BM03	PS.L.BM03.26	-
Negro mate	Mat black	1418.L.NM	C133.L.NM	-	-
Antracita	Anthracite	1418.L.ANT	-	-	-
ANODIZADOS	ANODIZED	REF.	REF.	REF.	REF.
Plata Brillo Repulido	Polished Silver	1418.A.P	-	-	-
Plata Mate	Natural Anodized	1418.A.PM	C133.A.PM	PS.A.PM.26	14181.A.PM
Inox Brillo Repulido	Inox	-	-	-	-
MELAMINA	MELAMINE	REF.	REF.	REF.	REF.
Blanco Rebornizable	White	1418.M.MR	C133.M.MR	-	-
MADERA	NATURAL WOOD	REF.	REF.	REF.	REF.
Roble Francés	Oak	1418.C.RB	-	-	-
Pino Gallego	Pine	1418.C.PN	-	-	-
Haya Blanca	Beech Tree	1418.C.Y	-	-	-

RTS22mm.

TIRADOR DE HOJA

RTS 22mm.

RTS 22mm.

HANDLE PROFILE

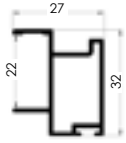
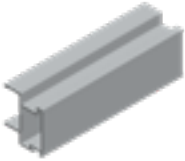

Longitud / Length : 2,6 m.

REF.

-

-

-

-

-

REF.

-

1485.A.PM

-

REF.

-

REF.

-

-

-

COMPLEMENTOS COMPLEMENTS

RODABLOC RR QUILLA

RR LOWER ROLLER



REF.	Descripción	Description
177	Rodabloc RR (Rueda Quilla) Guía Inferior GIO, GIEC, G170, G13P, UGIP, G150, G180	RR Lower Rail For GIO, GIEC, G170, G13P, UGIP, G150, G180 Lower Rail

RODABLOC RR QUILLA BLOQUEO FRONTAL

RR LOWER ROLLER WITH FRONT LOCK



REF.	Descripción	Description
171	Rodabloc RR Bloqueo (Quilla) Guía Inferior GIO, GIEC, G170, G13P, UGIP, G150, G180	Front lock RR Lower Rail For GIO, GIEC, G170, G13P, UGIP, G150, G180 Lower Rail

RODABLOC FR

FR LOWER ROLLER



REF.	Descripción	Description
174	Rodabloc FR (Rueda Quilla) Guía Inferior GIO, GIEC, G170, G13P, UGI, UGIP	FR Lower Rail For GIO, GIEC, G170, G13P, UGI, UGIP Lower Rail

RODABLOC REC QUILLA

REC LOWER ROLLER



REF.	Descripción	Description
1788	Rodabloc REC (Rueda Quilla) Guía Inferior GIO, GIEC, G170, G13P, UGI, UGIP	REC Lower Rail For GIO, GIEC, G170, G13P, UGI, UGIP Lower Rail

RODABLOC RDO

RDO LOWER ROLLER



REF.	Descripción	Description
173	Rodabloc RDO (Rueda Acanalada) Guía Inferior GICO	RDO Lower Rail For GICO Lower Rail

RODABLOC RD

RD LOWER RAIL



REF.	Descripción	Description
1701 (Con Limpiador)		

CABALLETE METÁLICO CON COJINETES Y GOMA S80

S80 METALLIC UPPER ROLLER WITH BEARINGS



REF.	Descripción	Description
1625S80	CBSS80 (Con Cojinetes)	CBSS80 (With Bearings)

CABALLETE METÁLICO CON COJINETES EXTRA Y GOMA S80

S80 METALLIC UPPER ROLLER WITH EXTRA BEARINGS



REF.	Descripción	Description
1629S80	CBSS80E (Con Cojinetes extra)	CBSS80E (With extra bearings)

CABALLETE METÁLICO SIN COJINETES Y GOMA S80

S80 METALLIC UPPER ROLLER WITHOUT BEARINGS



REF.	Descripción	Description
1661S80	CBSS80SC (Sin Cojinetes)	CBSS80SC (Without Bearings)

CUÑA INFERIOR DE FRENO GI80

GI80 BOTTON STOPPER



REF.	Descripción	Description
1634	Guía Inferior GI80	GI80 Lower Rail

ANTICABECEO-ANTIDESCARRILAMIENTO

DERAILMENT



REF.
182.S80

DESCÁRGATE LAS INSTRUCCIONES COMPLETAS EN:
www.adinor.info/instrucciones-de-montaje
 (Video Sistema Anticabeceo)

DOWNLOAD THE COMPLETE ASSEMBLY INSTRUCTIONS

TENSOR UNIÓN TIRADOR CTR6010mm CON H BT60

10mm CTR60 WITH BT60 HANDLE PROFILE



REF.	Bolsa / 4 un. / 4 un Box
BT302	

GOMA REDUCTORA VIDRIO 4mm BT60

BT60 PLASTIC GASKET FOR 4mm GLASS



REF.	Rollo / Roll: 100m.
BT303.4	

GOMA REDUCTORA VIDRIO 5mm BT60

BT60 PLASTIC GASKET FOR 5mm GLASS



REF.	Rollo / Roll: 100m.
BT303.5	

KIT DE HERRAJE ROLLER SET

KIT DE HERRAJE S80 - 16 - 19mm

S80 HARDWARE SET - 16-19mm



Ref. 177 - 2 Un.



Ref. 163 - 1 Un.



Ref. 1625S80 - 2 Un.

3,9x12



Ref. HT12 - 16 Un.

REF.
177.S80.KIT

KIT DE HERRAJE S80 - 10mm

S80 HARDWARE SET - 10mm



Ref. 177 - 2 Un.



Ref. 163 - 1 Un.



Ref. 1625S80 - 2 Un.

3,9x6,5



Ref. HT6.5- 16 Un.

REF.
17710.S80.KIT

KIT DE HERRAJE S80 - Min 10mm

S80 HARDWARE SET - Min 10mm



Ref. 177 - 2 Un.



Ref. 163 - 1 Un.



Ref. C350 - 4 Un.



Ref. 1625S80 - 2 Un.



Ref. C540 - 4 Un.

3,9x6,5



Ref. HT6.5- 16 Un.

REF.

177M10.S80.KIT

KIT DE HERRAJE S80 - Min 16mm

S80 HARDWARE SET - Min 16mm



Ref. 177 - 2 Un.



Ref. 163 - 1 Un.



Ref. C350 - 4 Un.



Ref. 1625S80 - 2 Un.



Ref. C540 - 4 Un.

3,9x12



Ref. HT12 - 16 Un.

REF.

177M16.S80.KIT

KIT DE HERRAJE S80 16 - 19mm RDO

S80 HARDWARE SET 16 - 19mm RDO



Ref. 173 - 2 Un.



Ref. 163 - 1 Un.



Ref. 1625S80 - 2 Un.

3,9x12



Ref. HT12 - 16 Un.

REF.

173.S80.KIT

KIT DE HERRAJE S80 10-16-19mm ECO

S80 HARDWARE SET 10-16-19mm ECO



Ref. 1788 - 2 Un.



Ref. 1661S80- 2 Un.

REF.

1788.S80.KIT

KIT DE HERRAJE S80- 16 - 19mm RD con limpiador

S80 HARDWARE SET 16 - 19mm RD



Ref. 1701 - 2 Un.



Ref. 163 - 1 Un.



Ref. 1625S80 - 2 Un.

3,9x12



Ref. HT12 - 16 Un.

REF.

1701.S80.KIT

AMORTIGUADORES FÁCIL MONTAJE (PATENTADO)

EASY ASSEMBLY SOFT CLOSING SYSTEM (PATENTED)

AMORTIGUADOR DE CIERRE IZQ.+DCH. GS80 15 KG. (sistema montaje rápido)

LEFT & RIGHT SELF-CLOSING SYSTEM UP TO 15KG. (EASY ASSEMBLY)



REF.
160S80AMOKIT15

AMORTIGUADOR DE CIERRE IZQ.+DCH. GS80 25 KG. (sistema montaje rápido)

LEFT & RIGHT SELF-CLOSING SYSTEM UP TO 25KG. (EASY ASSEMBLY)

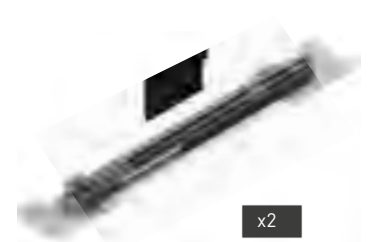

REF.
160S80AMOKIT25

AMORTIGUADOR DE CIERRE IZQ.+DCH. GS80 40 KG. (sistema montaje rápido)

LEFT & RIGHT SELF-CLOSING SYSTEM UP TO 40KG. (EASY ASSEMBLY)



REF.
160S80AMOKIT40

AMORTIGUADOR DE CIERRE IZQ.+DCH. GS80 60 KG. (sistema montaje rápido)

LEFT & RIGHT SELF-CLOSING SYSTEM UP TO 60KG. (EASY ASSEMBLY)



REF.
160S80AMOKIT60

AMORTIGUADOR DE CIERRE IZQ.+DCH. GS80 80 KG. (sistema montaje rápido)

LEFT & RIGHT SELF-CLOSING SYSTEM UP TO 80KG. (EASY ASSEMBLY)



REF.
160S80AMOKIT80

AMORTIGUADOR DE CIERRE IZQ.+DCH. GS80 100 KG. (sistema montaje rápido)

LEFT & RIGHT SELF-CLOSING SYSTEM UP TO 100KG. (EASY ASSEMBLY)



REF.
160S80AMOKIT100

AMORTIGUADOR DE CIERRE IZQ.+DCH. GS80 120 KG. (sistema montaje rápido)

LEFT & RIGHT SELF-CLOSING SYSTEM UP TO 120KG. (EASY ASSEMBLY)



REF.
160S80AMOKIT120

AMORTIGUADOR DE CIERRE CENTRAL GS80.

CENTRAL CLOSING SYSTEM



REF.	Descripción	Description
160S80AMOKITC25	Amortiguador central 25 kg	Central Self Closing System 25 kg.
160S80AMOKITC	Amortiguador central 40 kg.	Central Self Closing System 40 kg.

80mm MOLDURAS MOULDING

ADINOR

TAPETA_{70x11}

TAPETA DM
MDF FLAT ARCHITRAVE

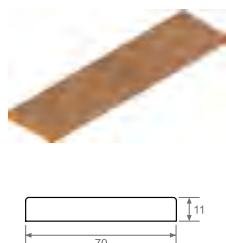

TAPETA_{150x8}

TAPETA DM
MDF FLAT ARCHITRAVE



ALUMINIO BATIENTE_{80x12}

BATIENTE DE ALUMINIO
ALUMINIUM DOOR STOP
MOULDING

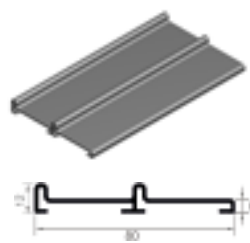

ACABADOS	FINISHINGS	Longitud / Length : 2,75 m.	Longitud / Length : 3,66 m.	Longitud / Length : 2,75 m.
LACADOS	COATED	REF.	REF.	REF.
Blanco Brillo Ral 9010	White	-	-	483.L.B
Blanco Mate	Mat white	-	-	483.L.BM
Blanco Mate Ral 9003	Mat white	-	-	483.L.BM03
Negro Mate	Mat black	-	-	483.L.NM
Antracita	Anthracite	-	-	483.L.ANT
ANODIZADOS	ANODIZED	REF.	REF.	REF.
Plata Brillo Repulido	Polished Silver	-	-	483.A.P
Plata Mate	Natural Anodized	-	-	483.A.PM
Inox Brillo Repulido	Inox	-	-	483.A.X
MELAMINA	MELAMINE	REF.	REF.	REF.
Roble A-0562	A-0562 Oak	432.M.RB562	434.M.RB562	483.M.RB562
Sapely D2517	Sapely	432.M.SPD	434.M.SPD	483.M.SPD
Cerezo Duero	Cherry Tree	432.M.CZD	434.M.CZD	483.M.CZD
Cerezo Tajo	Cherry Tree	-	-	483.M.CZT
Haya Vapor. 428	Steam Beech	432.M.YV	434.M.YV	483.M.YV
Blanco Rebarnizable	White	432.M.MR	434.M.MR	483.M.MR
Plata Mate	Silver	432.M.PM	434.M.PM	-
MADERA	NATURAL WOOD	REF.	REF.	REF.
Roble Francés	Oak	432.C.RB	434.C.RB	483.C.RB
Sapely	Sapely	432.C.SP	434.C.SP	483.C.SP
Cerezo	Cherry Tree	432.C.CZ	434.C.CZ	483.C.CZ
Pino	Pine	432.C.PN	434.C.PN	483.C.PN
Haya Blanca	Beech Tree	432.C.Y	434.C.Y	483.C.Y
Haya Vapor	Steam Beech	432.C.YV	434.C.YV	483.C.YV
VINILO	VINYL	REF.	REF.	REF.
Blanco RAL 9003	Blanco RAL 9003	432.V.9003	434.V.9003	483.V.9003
Halifax Natural	Natural Halifax	432.V.HN	434.V.HN	483.V.HN
Halifax Tabaco	Tabaco Halifax	432.V.HT	434.V.HT	483.V.HT
Halifax Blanco	White Halifax	432.V.HB	434.V.HB	483.V.HB
Blanco Pearl Touch	Pearl Touch White	432.V.BP	434.V.BP	483.V.BP
Blanco Sil	Sil White	432.V.BS	434.V.BS	483.V.BS



GS80 (REF 117)

**BATIENTE 80x12
(REF 483)**

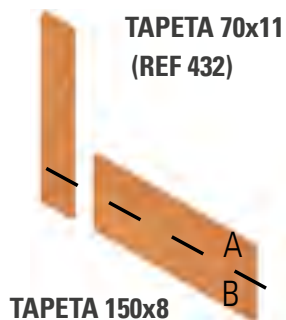

**TAPETA 70x11
(REF 432)**

**TAPETA 150x8
(REF 434)**

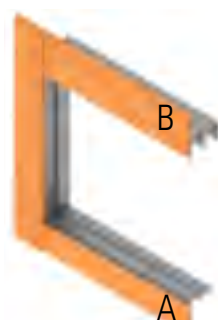

GI80 (REF 126)

80mm

KIT PUERTAS

SLIDING DOOR KIT

ADINOR

CONTENIDO DEL KIT

KIT ELEMENTS

Rueda Inferior con Rodamiento
Lower Roller with Bearings



x2

Tirador de Hoja
Handle Profile



x2

Bolsa Cepillo
Brush Bag



x1

Cuña de Freno
Upper Stopper



x1

Caballote metálico con goma y cojinetes
Metallic Upper Roller with Bearings



x2

Perfil Embellecedor U
U Profile

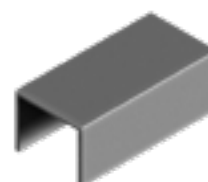

x1

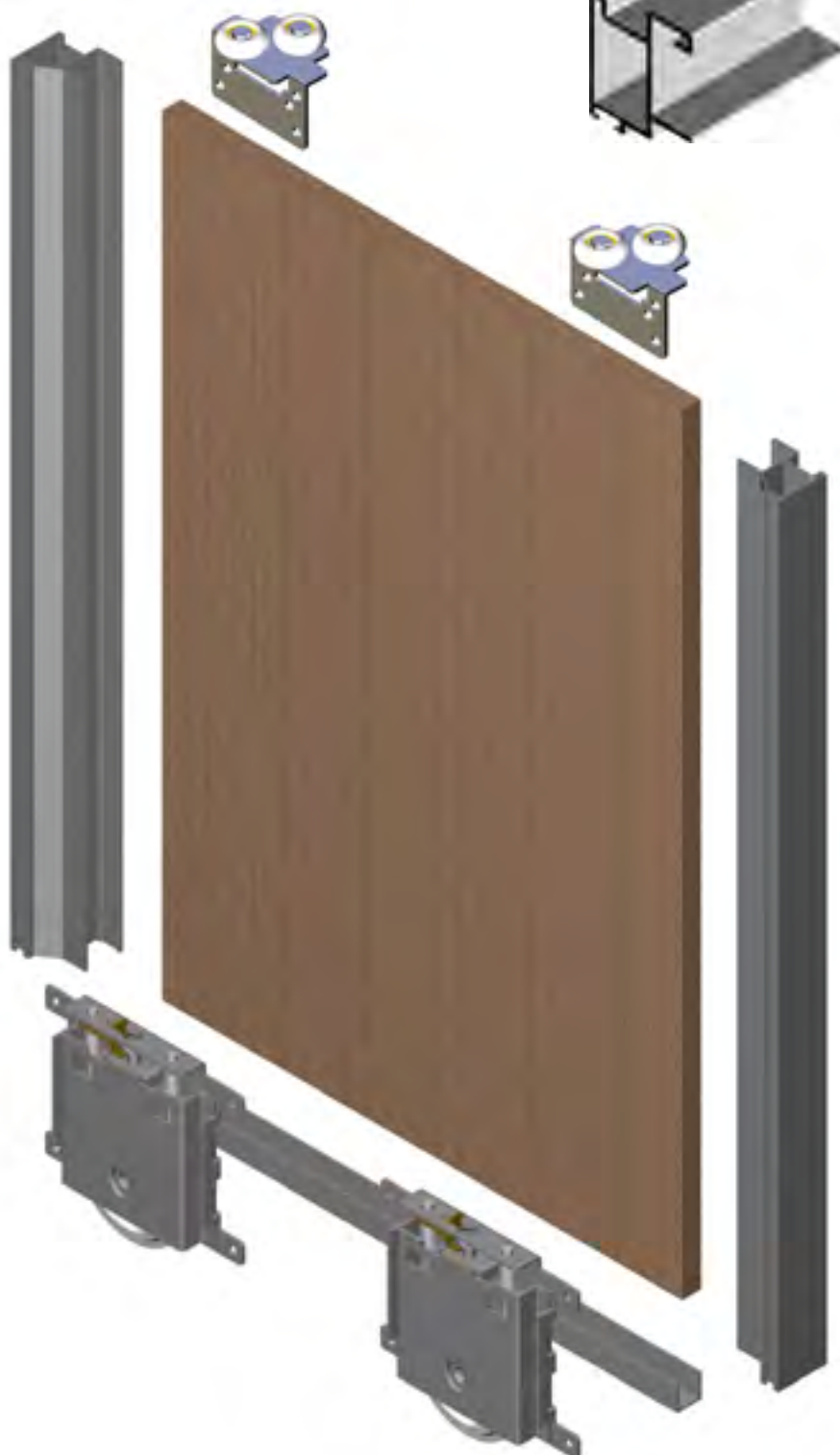

KIT
S016mm.

KIT
RTS16mm.

KIT
MINS16mm.

KIT
MINS10mm.

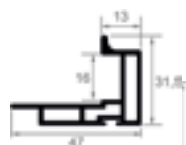

2,7m.

2,7m.

2,7m.

2,7m.

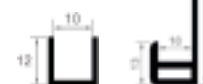

1,2m.

1,2m.

1,2m.

1,2m.

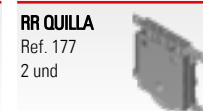
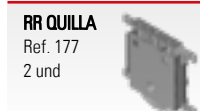
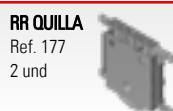

ACABADOS

FINISHINGS

LACADOS	COATED	REF.	REF.	REF.	REF.
Blanco Brillo Ral 9010	White	9205.B.L.B	9215.B.L.B	9465.B.L.B	9365.B.L.B
Blanco Mate Ral 9010	Mat white	9205.B.L.BM	9215.B.L.BM	9465.B.L.BM	9365.B.L.BM
Blanco Mate Ral 9003	Mat white	-	9215.B.L.BM03	9465.B.L.BM03	9365.B.L.BM03
Negro Mate	Mat Black	9205.B.L.NM	9215.B.L.NM	9465.B.L.NM	9365.B.L.NM
Antracita	Anthracite	9205.B.L.ANT	9215.B.L.ANT	9465.B.L.ANT	-
Oro	Gold	9205.B.L.O	-	-	-
ANODIZADOS	ANODIZED	REF.	REF.	REF.	REF.
Bronce	Bronce	9205.B.A.BR	-	-	-
Plata Brillo Repulido	Polished Silver	9205.B.A.P	9215.B.A.P	9465.B.A.P	9365.B.A.P
Plata Mate	Natural Anodized	9205.B.A.PM	9215.B.A.PM	9465.B.A.PM	9365.B.A.PM
Inox Brillo Repulido	Inox	-	9215.B.A.X	9465.B.A.X	-
MELAMINA	MELAMINE	REF.	REF.	REF.	REF.
Roble A-0562	Oak	9205.B.M.RB562	9215.B.M.RB562	9465.B.M.RB562	9365.B.M.RB562
Sapely D2517	Sapely	9205.B.M.SPD	9215.B.M.SPD	9465.B.M.SPD	9365.B.M.SPD
Cerezo Duero	Cherry Tree	9205.B.M.CZD	9215.B.M.CZD	-	9365.B.M.CZD
Cerezo Tajo	Cherry Tree	9205.B.M.CZT	-	-	-
Haya Vapor. 428	Steam Beech	9205.B.M.YV	9215.B.M.YV	-	9365.B.M.YV
Blanco Rebornizable	White	9205.B.M.MR	9215.B.M.MR	9465.B.M.MR	9365.B.M.MR
MADERA	NATURAL WOOD	REF.	REF.	REF.	REF.
Roble Francés	Oak	9205.B.C.RB	9215.B.C.RB	9465.B.C.RB	9365.B.C.RB
Sapely	Sapely	9205.B.C.SP	9215.B.C.SP	9465.B.C.SP	9365.B.C.SP
Cerezo	Cherry Tree	9205.B.C.CZ	9215.B.C.CZ	9465.B.C.CZ	9365.B.C.CZ
Pino	Pine	9205.B.C.PN	9215.B.C.PN	9465.B.C.PN	9365.B.C.PN
Haya Blanca	Beech Tree	9205.B.C.Y	9215.B.C.Y	9465.B.C.Y	9365.B.C.Y
Haya Vapor	Steam Beech	9205.B.C.YV	9215.B.C.YV	9465.B.C.YV	-
VINILO	VINYL	REF.	REF.	REF.	REF.
Blanco RAL 9003	Blanco RAL 9003	9205.B.V.9003	9215.B.V.9003	-	-
Blanco Sil	Sil White	-	9215.B.V.BS	-	-
Blanco Perla	Pearl White	-	-	-	-
Halifax Natural	Natural Halifax	-	9215.B.V.HN	-	-
Halifax Tabaco	Tabaco Halifax	-	9215.B.V.HT	-	-
Halifax Blanco	White Halifax	-	9215.B.V.HB	-	-

KIT
RTS10mm.

KIT
RTS19mm.

KIT
MINS19mm.

KIT
TZMS16mm.

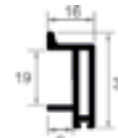
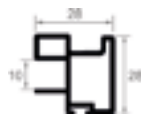
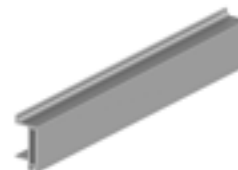
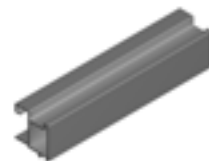

2,7m.

2,7m.

2,7m.

2,7m.



1,2m.

1,2m.

1,2m.

1,2m.



ACABADOS	FINISHINGS	RR QUILLA Ref. 177 2 und	RR QUILLA Ref. 177 2 und	RR QUILLA Ref. 177 2 und	RR QUILLA Ref. 177 2 und
LACADOS	COATED	REF.	REF.	REF.	REF.
Blanco Brillo Ral 9010	White	91410.B.L.B	9335.B.L.B	9466.B.L.B	944.B.L.B
Blanco Mate Ral 9010	Mat white	-	9335.B.L.BM	9466.B.L.BM	944.B.L.BM
Blanco Mate Ral 9003	Mat white	91410.B.L.BM03	9335.B.L.BM03	9466.B.L.BM03	-
Negro Mate	Mat Black	91410.B.L.NM	9335.B.L.NM	9466.L.NM	944.B.L.NM
Antracita	Anthracite	-	9335.B.L.ANT	-	-
Oro	Gold	-	-	-	-
ANODIZADOS	ANODIZED	REF.	REF.	REF.	REF.
Bronce Brillo Repulido	Bronce	-	-	-	-
Plata Brillo Repulido	Polished Silver	91410.B.A.P	9335.B.A.P	-	944.B.A.P
Plata Mate	Natural Anodized	91410.B.A.PM	9335.B.A.PM	9466.B.A.PM	944.B.A.PM
Inox Brillo Repulido	Inox	-	-	-	-
MELAMINA	MELAMINE	REF.	REF.	REF.	REF.
Roble A-0562	Oak	91410.B.M.RB562	-	-	944.B.M.RB562
Sapely D2517	Sapely	91410.B.M.SPD	-	-	944.B.M.SPD
Cerezo Duero	Cherry Tree	91410.B.M.CZD	-	-	944.B.M.CZD
Haya Vapor. 428	Steam Beech	91410.B.M.YV	-	-	944.B.M.YV
Blanco Rebornizable	White	91410.B.M.MR	9335.B.M.MR	9466.B.M.MR	944.B.M.MR
MADERA	NATURAL WOOD	REF.	REF.	REF.	REF.
Roble Francés	Oak	91410.B.C.RB	-	-	944.B.C.RB
Sapely	Sapely	91410.B.C.SP	-	-	944.B.C.SP
Cerezo	Cherry Tree	91410.B.C.CZ	-	-	944.B.C.CZ
Pino	Pine	91410.B.C.PN	-	-	944.B.C.PN
Haya Blanca	Beech Tree	91410.B.C.Y	-	-	944.B.C.Y
VINILO	VINYL	REF.	REF.	REF.	REF.
Blanco RAL 9003	White RAL 9003	91410.B.V.9003	-	-	-
Blanco Sil	Sil White	-	-	-	-
Blanco Perla Touch	Pearl Touch White	-	-	-	-
Halifax Natural	Natural Halifax	-	-	-	-
Halifax Tabaco	Tabaco Halifax	-	-	-	-
Halifax Blanco	White Halifax	-	-	-	-

KIT
PS19mm.

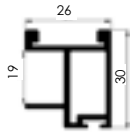
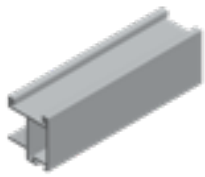

2,6m.



1,2m.

KIT
MSE16mm.

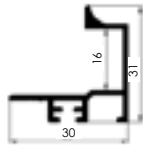

2,6m.

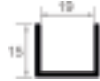

1m.

KIT
CT80 16mm.

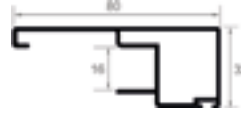
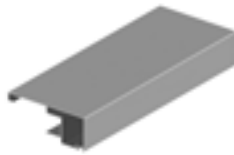

2,7m.



1un.

GS80-GI83

KIT GUÍA
TRACKS KIT

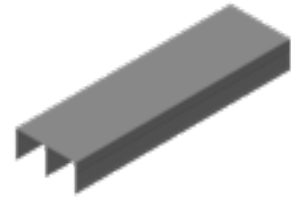

Ref. 117

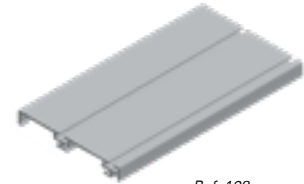
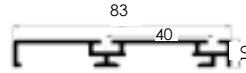

Ref. 128



Ref. 193

RR QUILLA
Ref. 177
2 und



RR QUILLA
Ref. 177
2 und



RR QUILLA
Ref. 177
2 und



2 m.

3 m.

4 m.

REF.	REF.	REF.
-	9C124.B.L.B	-
-	-	-
9PS.B.L.BM03	-	-
-	-	-
-	-	-
-	-	-
REF.	REF.	REF.
-	-	-
-	-	-
9PS.B.A.PM	9C124.B.A.PM	-
-	-	-
REF.	REF.	REF.
-	-	-
-	-	-
-	-	-
-	9C124.B.M.MR	9140.B.M.MR
REF.	REF.	REF.
-	-	9140.B.C.RB
-	-	9140.B.C.SP
-	-	9140.B.C.CZ
-	-	9140.B.C.PN
-	-	9140.B.C.Y
REF.	REF.	REF.
-	9C124.B.V.9003	9140.B.V.9003
-	-	-
-	-	9140.B.V.BP
-	-	-
-	-	-
-	-	-

REF.	REF.	REF.
937.L.B.2	937.L.B.3	937.L.B.4
-	-	-
937.L.BM03.2	937.L.BM03.3	937.L.BM03.4
937.L.NM.2	937.L.NM.3	937.L.NM.4
-	-	-
-	-	-
REF.	REF.	REF.
-	-	-
-	-	-
937.A.PM.2	937.A.PM.3	937.A.PM.4
-	-	-
REF.	REF.	REF.
-	-	-
-	-	-
-	-	-
-	-	-
-	-	-
REF.	REF.	REF.
-	-	-
-	-	-
-	-	-
-	-	-
-	-	-

80mm

KIT GUÍAS TRACKS KIT

ADINOR

GS80-GI80

KIT GUÍA
TRACKS KIT

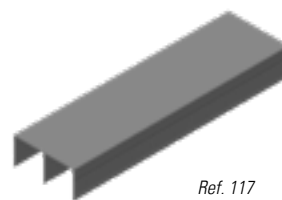

Ref. 117

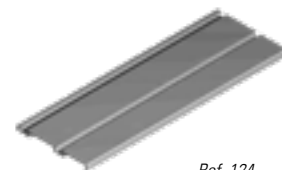
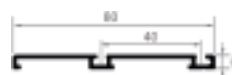

Ref. 124



Ref. 193

ACABADOS	FINISHINGS
LACADOS	COATED
Blanco Brillo Ral 9010	White
Blanco Mate Ral 9010	Mat white
Blanco Mate Ral 9003	Mat white
Negro Mate	Mat Black
Antracita	Anthracite
Oro	Gold
ANODIZADOS	ANODIZED
Bronce Brillo Repulido	Bronce
Plata Brillo Repulido	Polished Silver
Plata Mate	Natural Anodized
Inox Brillo Repulido	Inox
MELAMINA	MELAMINE
Roble A-0562	Oak
Sapely D2517	Sapely
Cerezo Duero	Cherry Tree
Haya Vapor. 428	Steam Beech
Blanco Rebornizable	White
MADERA	NATURAL WOOD
Roble Francés	Oak
Sapely	Sapely
Cerezo	Cherry Tree
Pino	Pine
Haya Blanca	Beech Tree
Haya Vapor	Steam Beech
VINILO	VINYL
Blanco RAL 9003	White RAL 9003
Blanco Sil	Sil White
Blanco Perla Touch	Pearl Touch White
Halifax Natural	Natural Halifax
Halifax Tabaco	Tabaco Halifax
Halifax Blanco	White Halifax

2 m.	3 m.	4 m.
REF.	REF.	REF.
934.L.B.2	934.L.B.3	934.L.B.4
934.L.BM.2	934.L.BM.3	934.L.BM.4
934.L.BM03.2	934.L.BM03.3	934.L.BM03.4
934.L.NM.2	934.L.NM.3	934.L.NM.4
934.L.ANT.2	934.L.ANT.3	934.L.ANT.4
934.L.O.2	934.L.O.3	934.L.O.4
REF.	REF.	REF.
934.A.BR.2	934.A.BR.3	934.A.BR.4
934.A.P.2	934.A.P.3	934.A.P.4
934.A.PM.2	934.A.PM.3	934.A.PM.4
934.A.X.2	934.A.X.3	934.A.X.4
REF.	REF.	REF.
934.M.RB562.2	934.M.RB562.3	934.M.RB562.4
934.M.SPD.2	934.M.SPD.3	934.M.SPD.4
934.M.CZD.2	934.M.CZD.3	934.M.CZD.4
934.M.YV.2	934.M.YV.3	934.M.YV.4
934.M.MR.2	934.M.MR.3	934.M.MR.4
REF.	REF.	REF.
934.C.RB.2	934.C.RB.3	934.C.RB.4
934.C.SP.2	934.C.SP.3	934.C.SP.4
934.C.CZ.2	934.C.CZ.3	934.C.CZ.4
934.C.PN.2	934.C.PN.3	934.C.PN.4
934.C.Y.2	934.C.Y.3	934.C.Y.4
934.C.YV.2	934.C.YV.3	934.C.YV.4
REF.	REF.	REF.
934.V.9003.2	934.V.9003.3	934.V.9003.4
934.V.BS.2	934.V.BS.3	934.V.BS.4
934.V.BP.2	934.V.BP.3	934.V.BP.4
934.V.HN.2	934.V.HN.3	934.V.HN.4
934.V.HT.2	934.V.HT.3	934.V.HT.4
934.V.HB.2	934.V.HB.3	934.V.HB.4

GS80-GI50

KIT GUÍA
TRACKS KIT

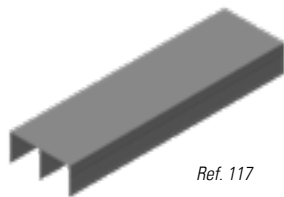

Ref. 117

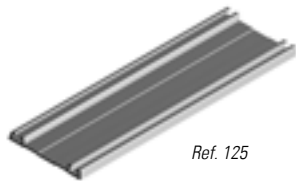

Ref. 125

GS803P-GI803P

KIT GUÍA
TRACKS KIT

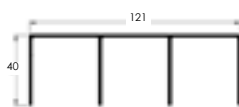

Ref. 118

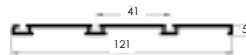

Ref. 1295



Ref. 193

2 m.	3 m.	4 m.
REF.	REF.	REF.
935.L.B.2	935.L.B.3	935.L.B.4
-	-	-
-	-	-
-	-	-
-	-	-
-	-	-
REF.	REF.	REF.
-	-	-
-	-	-
935.A.PM.2	935.A.PM.3	935.A.PM.4
-	-	-
REF.	REF.	REF.
-	-	-
-	-	-
-	-	-
-	-	-
REF.	REF.	REF.
-	-	-
-	-	-
-	-	-
-	-	-

2 m.	3 m.	4 m.
REF.	REF.	REF.
938.L.B.2	938.L.B.3	938.L.B.4
-	-	-
-	-	-
-	-	-
-	-	-
-	-	-
REF.	REF.	REF.
-	-	-
-	-	-
938.A.PM.2	938.A.PM.3	938.A.PM.4
-	-	-
REF.	REF.	REF.
-	-	-
-	-	-
-	-	-
-	-	-
REF.	REF.	REF.
-	-	-
-	-	-
-	-	-
-	-	-

80mm

INSTRUCCIONES DE MONTAJE

ASSEMBLY INSTRUCTIONS

ADINOR

ALTURA PUERTA / DOOR HEIGHT

	SIN AMORTIGUADOR WITHOUT SELF CLOSING SYSTEM	CON AMORTIGUADOR WITH SELF CLOSING SYSTEM
	GS80 	GS80
GI2A 80	H - 65	H - 75
GI80	H - 30	H - 40
GI50	H - 30	H - 40

Para solape según dibujo esquema
Doors superposed according to drawing

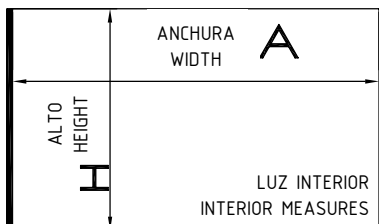

ACCEDE AL PROGRAMA DE DESPIECE DE CADA SERIE EN:

www.adinor.info/programa-de-despiece

USE THE DOORS CUTTING SOFTWARE

ANCHURA DEL TABLERO / BOARD WIDTH (C)

		SO 16mm.	RTS 16mm.	MINS 16mm.	MINS 10mm.	TZMS 16mm.	CT80 16mm.	RTS 19mm.
2 PUERTAS	2 BOARDS	$\frac{A - 50}{2}$	$\frac{A - 39}{2}$	$\frac{A - 14}{2}$	$\frac{A - 14}{2}$	$\frac{A - 64}{2}$	$\frac{A - 20}{2}$	$\frac{A - 39}{2}$
3 PUERTAS	3 BOARDS	$\frac{A - 60}{3}$	$\frac{A - 44}{3}$	$\frac{A - 14}{3}$	$\frac{A - 14}{3}$	$\frac{A - 76}{3}$	$\frac{A + 10}{3}$	$\frac{A - 44}{3}$
4 PUERTAS	4 BOARDS	$\frac{A - 100}{4}$	$\frac{A - 78}{4}$	$\frac{A - 28}{4}$	$\frac{A - 28}{4}$	$\frac{A - 128}{4}$	$\frac{A - 40}{4}$	$\frac{A - 78}{4}$
		MINS 19mm.	RTS 10mm.	CTR60 10mm.	MSE	RTS 22mm.	PS 19mm.	RTCS 19mm.
2 PUERTAS	2 BOARDS	$\frac{A - 12}{2}$	$\frac{A - 39}{2}$	$\frac{A - 116}{2}$	$\frac{A + 5}{2}$	$\frac{A - 39}{2}$	$\frac{A - 30}{2}$	$\frac{A - 39}{2}$
3 PUERTAS	3 BOARDS	$\frac{A - 10}{3}$	$\frac{A - 45}{3}$	$\frac{A - 144}{3}$	$\frac{A + 12}{3}$	$\frac{A - 44}{3}$	$\frac{A - 32}{3}$	$\frac{A - 44}{3}$
4 PUERTAS	4 BOARDS	$\frac{A - 24}{4}$	$\frac{A - 78}{4}$	$\frac{A - 232}{4}$	$\frac{A + 10}{4}$	$\frac{A - 78}{4}$	$\frac{A - 60}{4}$	$\frac{A - 78}{4}$

LONGITUD CORTE PERFIL H, U / H, U PROFILE HEIGHT

SO 16mm.	RTS 16mm.	MINS 16mm.	MINS 10mm.	TZMS 16mm.	CT80 16mm.	RTS 19mm.
C - 23	C - 21	C - 13	C - 13	C - 27	C - 109	C - 21
PS 19mm.	RTCS 19mm.	MINS 19mm.	RTS 10mm.	CTR60 10mm.	MSE	RTS 22mm.
C - 23	C - 21	C - 16	C - 21	C - 31	C - 18	C - 21

SERIE 85

85 SERIE

85mm

ADINOR

GS2B

GUÍA SUPERIOR 2B
2B UPPER RAIL

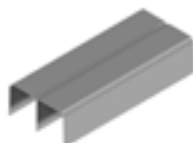

GI2A

GUÍA INF. CERRADA 2A
2A LOWER RAIL

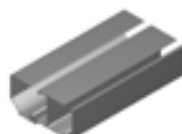

GI5F

GUÍA INFERIOR 5F
5F LOWER RAIL



6m. Condiciones especiales de envío
6m. Special shipping conditions



ACABADOS	FINISHINGS	Longitud / Lenght : 6 m.	Longitud / Lenght : 6 m.	Longitud / Lenght : 6 m.
LACADOS	COATED	REF.	REF.	REF.
Blanco Brillo Ral9010	White Ral9010	111.L.B	121.L.B	137.L.B
Negro Mate	Mat Black	111.L.NM	121.L.NM	137.L.NM
Blanco Mate Ral9010	White Mat Ral9010	111.L.BM	121.L.BM	137.L.BM
Blanco Mate Ral9003	White Mat Ral9003	111.L.BM03	121.L.BM03	137.L.BM03
Oro	Gold	111.L.O	121.L.O	137.L.O
ANODIZADOS	ANODIZED	REF.	REF.	REF.
Bronce Brillo Repulido	Bronce	111.A.BR	121.A.BR	137.A.BR
Plata Brillo Repulido	Polished Silver	111.A.P	121.A.P	137.A.P
Plata Mate	Natural Anodized	111.A.PM	121.A.PM	137.A.PM
Bronce Mate	Bronce Mat	-	-	-
MELAMINA	MELAMINE	REF.	REF.	REF.
Roble RO 444	Oak	111.M.RBRO	121.M.RBRO	137.M.RBRO
Sapely Rameado	Sapely	111.M.SP	121.M.SP	137.M.SP
Cerezo Duero	Cherry Tree	111.M.CZD	121.M.CZD	137.M.CZD
Haya Vaporizada 428	Steam Beech	111.M.YV	121.M.YV	137.M.YV
Wengue Congo	Wengue	111.M.W	121.M.W	137.M.W
Blanco Rebornizable	White	111.M.MR	121.M.MR	137.M.MR
MADERA	NATURAL WOOD	REF.	REF.	REF.
Roble Francés	Oak	111.C.RB	121.C.RB	137.C.RB
Sapely	Sapely	111.C.SP	121.C.SP	137.C.SP
Cerezo	Cherry Tree	111.C.CZ	121.C.CZ	137.C.CZ
Pino Gallego	Pine	111.C.PN	121.C.PN	137.C.PN
Haya Blanca	Beech Tree	111.C.Y	121.C.Y	137.C.Y
Haya Vaporizada	Steam Beech	111.C.YV	121.C.YV	137.C.YV

TZM16mm.

TIRADOR DE HOJA TZM
TZM HANDLE PROFILE



JP16mm.

TIRADOR DE HOJA JP
JP HANDLE PROFILE

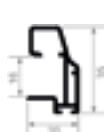

RTS19mm.

TIRADOR DE HOJA RTS
RTS HANDLE PROFILE

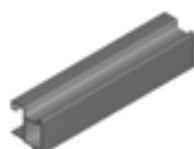

MINS16mm.

TIRADOR HOJA MINS16mm.
MINS16mm. HANDLE PROFILE

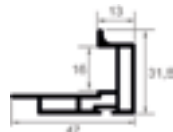
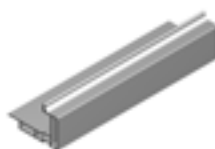

FALDÓN MIN16mm.

PERFIL FALDON SUP/INF
UPPER/LOWER
CONNECTION PROFILE



MINS19mm.

TIRADOR DE HOJA
MINS19mm.
MINS19mm.
HANDLE PROFILE

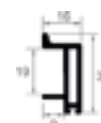
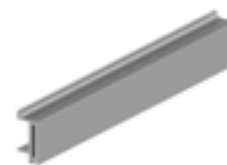

Longitud / Length : 2,5 m.	Longitud / Length : 2,5 m.	Longitud / Length : 2,7 m.	Longitud / Length : 2,7 m.	Longitud / Length : 6 m.	Longitud / Length : 2,7 m.
REF.	REF.	REF.	REF.	REF.	REF.
-	148.L.B	1418.L.B	C123.L.B	C220.L.B	C133.L.B
-	148.L.NM	1418.L.NM	-	-	-
-	-	1418.L.BM	-	-	-
-	-	1418.L.BM03	-	-	-
-	148.L.O	-	-	-	-
REF.	REF.	REF.	REF.	REF.	REF.
-	-	-	-	-	-
-	148.A.P	1418.A.P	C123.A.P	C220.A.P	-
-	148.A.PM	1418.A.PM	C123.A.PM	C220.A.PM	C133.A.PM
-	-	-	-	-	-
REF.	REF.	REF.	REF.	REF.	REF.
-	148.M.RBRO	-	C123.M.RBRO	C220.M.RBRO	-
-	148.M.SP	-	-	-	-
-	148.M.CZD	-	-	-	-
-	148.M.YV	-	-	-	-
-	148.M.W	-	-	-	-
-	148.M.MR	1418.M.MR	C123.M.MR	C220.M.MR	C133.M.MR
REF.	REF.	REF.	REF.	REF.	REF.
140M.C.RB	148.C.RB	1418.C.RB	C123.C.RB	C220.C.RB	-
140M.C.SP	148.C.SP	-	C123.C.SP	C220.C.SP	-
140M.C.CZ	148.C.CZ	-	C123.C.CZ	C220.C.CZ	-
140M.C.PN	148.C.PN	1418.C.PN	C123.C.PN	C220.C.PN	-
140M.C.Y	148.C.Y	1418.C.Y	C123.C.Y	C220.C.Y	-
140M.C.YV	148.C.YV	-	-	-	-

85mm

ADINOR

MC16mm.

TIRADOR DE HOJA MC
MC HANDLE PROFILE



FHP16mm.

TIRADOR DE HOJA FHP
FHP HANDLE PROFILE

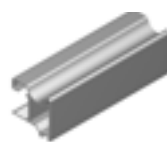

CT80mm.

TIRADOR DE HOJA CT
CT HANDLE PROFILE

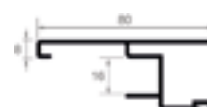

DB16mm.

TIRADOR DE HOJA DB
DB HANDLE PROFILE

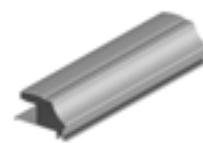

ACABADOS	FINISHINGS	Longitud / Length : 2,5 m.	Longitud / Length : 2,5 m.	Longitud / Length : 2,7 m.	Longitud / Length : 2,5 m.
LACADOS	COATED	REF.	REF.	REF.	REF.
Blanco Brillo Ral 9010	White Ral 9010	142.L.B	1471.L.B	-	149.L.B
Negro Mate	Mat black	142.L.NM	-	-	-
Blanco Mate Ral 9010	Mat white	142.L.BM	-	-	-
Blanco Mate Ral 9003	Mat white	142.L.BM03	-	-	-
Oro	Gold	142.L.O	1471.L.O	-	-
ANODIZADOS	ANODIZED	REF.	REF.	REF.	REF.
Bronce Brillo Repulido	Bronce	142.A.BR	1471.A.BR	-	-
Plata Brillo Repulido	Polished Silver	142.A.P	1471.A.P	-	149.A.P
Plata Mate	Natural Anodized	142.A.PM	1471.A.PM	-	149.A.PM
Bronce Mate	Bronce Mat	-	-	-	-
MELAMINA	MELAMINE	REF.	REF.	REF.	REF.
Roble RO 444	Oak	142.M.RBRO	1471.M.RBRO	-	149.M.RBRO
Sapely Rameado	Sapely	142.M.SP	1471.M.SP	-	149.M.SP
Cerezo Duero	Cherry Tree	142.M.CZD	1471.M.CZD	-	149.M.CZD
Haya Vaporizada 428	Steam Beech	142.M.YV	1471.M.YV	-	149.M.YV
Wengue Congo	Wengue	142.M.W	1471.M.W	-	-
Blanco Rebarnizable	White	142.M.MR	1471.M.MR	140.M.MR	149.M.MR
MADERA	NATURAL WOOD	REF.	REF.	REF.	REF.
Roble Francés	Oak	142.C.RB	1471.C.RB	140.C.RB	149.C.RB
Sapely	Sapely	142.C.SP	1471.C.SP	140.C.SP	149.C.SP
Cerezo	Cherry Tree	142.C.CZ	1471.C.CZ	140.C.CZ	149.C.CZ
Pino Gallego	Pine	142.C.PN	1471.C.PN	140.C.PN	149.C.PN
Haya Blanca	Beech Tree	142.C.Y	1471.C.Y	140.C.Y	149.C.Y
Haya Vaporizada	Steam Beech	142.C.YV	1471.C.YV	-	149.C.YV

RODABLOC RR QUILLA

RR LOWER RAIL

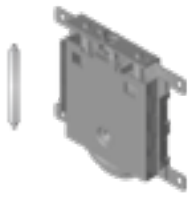

REF.	Descripción	Description
177	Rodabloc RR (Rueda Quilla) Guía Inferior GI5F, GI4F, UGI	RR Lower Rail For GI5F, GI4F, UGI Lower Rail

RODABLOC RDO

RDO LOWER RAIL



REF.	Descripción	Description
173	Rodabloc RDO (Rueda Acanalada) Guía Inferior GI2A	RDO Lower Rail For GI2A Lower Rail

RODABLOC RD

RD LOWER RAIL



REF.
170
1701 (Con Limpiador)

CABALLETE METÁLICO, GOMA Y COJINETES

METALLIC UPPER ROLLER
WITH BEARINGS



REF.
165MN

CABALLETE CEPILLO CB

CB UPPER ROLLER



REF.
162

PLETINA Y CILINDRO MAGNÉTICO

MAGNETIC PLATE AND CYLINDER



REF.	Descripción	Description
164	Cilindro	Cylinder
1641	Pletina	Plate

CUÑA DE FRENO INFERIOR

BOTTON STOPPER



REF.	Descripción	Description
1631	Guía Inferior GI4F, UGI, GIO	Lower Rail GI4F, UGI, GIO
1633	Guía Inferior GI5F	Lower Rail GI5F

CUÑA DE FRENO INFERIOR DOBLE PATILLA

BOTTON STOPPER



REF.	Descripción	Description
1632	Guía Inferior UGI, UGIP	Lower Rail UGI, UGIP

JUEGO IMÁN

MAGNETIC LOCK SET



REF.
185

AMORTIGUADOR DE CIERRE GS2B 10-80 KG

10-80 KG GS2B SELF-CLOSING SYSTEM



REF.	Descripción	Description
167	10-80 kg. Derecho	10-80 kg. Right
168	10-80 kg. Izquierdo	10-80 kg. Left

DESCÁRGATE EL PROGRAMA DE DESPIECE DE CADA SERIE EN:
www.adinor.info/programa-de-despiece
DOWNLOAD THE COMPLETE ASSEMBLY INSTRUCTIONS

85mm

MOLDURAS

MOULDING

ADINOR

90X12

BATIENTE DM
MDF DOOR STOP MOULDING

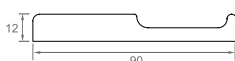

80X5

TAPETA DM
MDF FLAT ARCHITRAVE

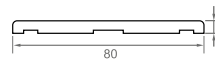

TAPETA 70X11

TAPETA DM
MDF FLAT ARCHITRAVE

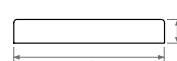

TAPETA 150x8

TAPETA DM
MDF FLAT ARCHITRAVE



ACABADOS	FINISHINGS	Longitud / Lenght : 2,75 m.	Longitud / Lenght : 2,75 m.	Longitud / Lenght : 2,75 m.	Longitud / Lenght : 3,66 m.
MELAMINA	MELAMINE	REF.	REF.	REF.	REF.
Roble RO 444	Oak	482.M.RBRO	-	432.M.RBRO	434.M.RBRO
Sapely Rameado	Sapely	482.M.SP	-	432.M.SP	434.M.SP
Cerezo Duero	Cherry Tree	482.M.CZD	-	432.M.CZD	434.M.CZD
Haya Vaporizada 428	Steam Beech	482.M.YV	-	432.M.YV	434.M.YV
Wengue Congo	Wengue	482.M.W	-	432.M.W	434.M.W
Blanco Rebornizable	White	482.M.MR	4856.M.MR	432.M.MR	434.M.MR
Plata Mate	Natural Anodized	482.M.PM	-	432.M.PM	434.M.PM
MADERA	NATURAL WOOD	REF.	REF.	REF.	REF.
Roble Francés	Oak	482.C.RB	4856.C.RB	432.C.RB	434.C.RB
Sapely	Sapely	482.C.SP	4856.C.SP	432.C.SP	434.C.SP
Cerezo	Cherry Tree	482.C.CZ	4856.C.CZ	432.C.CZ	434.C.CZ
Pino	Pine	482.C.PN	4856.C.PN	432.C.PN	434.C.PN
Nogal	Wallnut	482.C.NG	-	-	-
Haya Blanca	Beech Tree	482.C.Y	4856.C.Y	432.C.Y	434.C.Y
Haya Vaporizada	Steam Beech	482.C.YV	-	432.C.YV	434.C.YV
VINILOS	VYNILS	REF.	REF.	REF.	REF.
Blanco Sil	White sil	-	4856.V.BS	432.V.BS	434.V.BS
Blanco Perla	Pearl white	-	4856.V.BP	432.V.BP	434.V.BP
Halifax Natural	Natural Halifax	-	4856.V.HN	432.V.HN	434.V.HN
Halifax Tabaco	Tabaco Halifax	-	4856.V.HT	432.V.HT	434.V.HT
Halifax Blanco	White Halifax	-	4856.V.HB	432.V.HB	434.V.HB

85mm

KIT PUERTAS

SLIDING DOOR KIT

ADINOR

CONTENIDO DEL KIT

KIT ELEMENTS



Tirador de Hoja
Handle Profile

Rueda Inferior con Rodamiento
Lower Roller with Bearings

x2

Bolsa Cepillo
Brush Bag

x2



x1

Cuña de Freno
Upper Stopper

x1

Caballote metálico con goma y cojinetes
Metallic Upper Roller with Bearings

x2

Perfil Embellecedor U
U Profile

x1

85mm

KIT PUERTAS SLIDING DOOR KIT

ADINOR

FHP16mm

KIT DE PUERTA
SLIDING DOOR KIT



Ref. 1471 - 2x2,5 m



Ref. 16060 - 2x2,5 m.



Ref. 152 - 1x1m.



Ref. 165MN - 2 un.



Ref. 163 - 1 un.

JP16mm

KIT DE PUERTA
SLIDING DOOR KIT



Ref. 148 - 2x2,5 m



Ref. 16060 - 2x2,5 m.



Ref. 152 - 1x1m.



Ref. 165MN - 2 un.



Ref. 163 - 1 un.

RR QUILLA

Ref. 177
2 und



RD CON LIMPIADOR

Ref. 1701
2 und



RR QUILLA

Ref. 177
2 und



RD CON LIMPIADOR

Ref. 1701
2 und



ACABADOS	FINISHINGS	RR QUILLA Ref. 177 2 und	RD CON LIMPIADOR Ref. 1701 2 und	RR QUILLA Ref. 177 2 und	RD CON LIMPIADOR Ref. 1701 2 und
LACADOS	COATED	REF.	REF.	REF.	REF.
Blanco Brillo Ral 9010	White	920.B.L.B	920.RD.L.B	921.B.L.B	921.RD.L.B
Oro	Gold	-	-	-	-
ANODIZADOS	ANODIZED	REF.	REF.	REF.	REF.
Bronce Brillo Repulido	Bronce	-	-	-	-
Plata Brillo Repulido	Polished Silver	920.B.A.P	920.RD.A.P	921.B.A.P	921.RD.A.P
Plata Mate	Natural Anodized	920.B.A.PM	920.RD.A.PM	921.B.A.PM	921.RD.A.PM
MELAMINA	MELAMINE	REF.	REF.	REF.	REF.
Roble RO 444	Oak	920.B.M.RBRO	920.RD.M.RBRO	921.B.M.RBRO	921.RD.M.RBRO
Sapely Rameado	Sapely	920.B.M.SP	920.RD.M.SP	921.B.M.SP	921.RD.M.SP
Cerezo Duero	Cherry Tree	920.B.M.CZD	920.RD.M.CZD	921.B.M.CZD	921.RD.M.CZD
Haya Vapor. 428	Steam Beech	920.B.M.YV	920.RD.M.YV	921.B.M.YV	921.RD.M.YV
Wengue Congo	Wengue	920.B.M.W	920.RD.M.W	921.B.M.W	921.RD.M.W
Blanco Rebornizable	White	-	-	921.B.M.MR	921.RD.M.MR
MADERA	NATURAL WOOD	REF.	REF.	REF.	REF.
Roble Francés	Oak	920.B.C.RB	920.RD.C.RB	921.B.C.RB	921.RD.C.RB
Sapely	Sapely	921.B.C.SP	921.RD.C.SP	921.B.C.SP	921.RD.C.SP
Cerezo	Cherry Tree	920.B.C.CZ	920.RD.C.CZ	921.B.C.CZ	921.RD.C.CZ
Pino	Pine	920.B.C.PN	920.RD.C.PN	921.B.C.PN	921.RD.C.PN
Haya Blanca	Beech Tree	920.B.C.Y	920.RD.C.Y	921.B.C.Y	921.RD.C.Y
Haya Vaporizada	Steam Beech	920.B.C.YV	920.RD.C.YV	921.B.C.YV	921.RD.C.YV

MINS16mm

KIT DE PUERTA
SLIDING DOOR KIT



RTS19mm

KIT DE PUERTA
SLIDING DOOR KIT



RR QUILLA

Ref. 177
2 und



RR QUILLA

Ref. 177
2 und



ACABADOS

FINISHINGS

LACADOS	COATED	REF.
Blanco Brillo Ral 9010	White	946.B.L.B
Negro Mate	Mat black	946.B.L.NM
ANODIZADOS	ANODIZED	REF.
Bronce Brillo Repulido	Bronce	-
Plata Brillo Repulido	Polished Silver	946.B.A.P
Plata Mate	Natural Anodized	946.B.A.PM
MELAMINA	MELAMINE	REF.
Roble RO 444	Oak	946.B.M.RBRO
Sapely Rameado	Sapely	-
Cerezo Duero	Cherry Tree	-
Haya Vapor. 428	Steam Beech	-
Wengue Congo	Wengue	-
Blanco Rebarnizable	White	946.B.M.MR
MADERA	NATURAL WOOD	REF.
Roble Francés	Oak	946.B.C.RB
Sapely	Sapely	946.B.C.SP
Cerezo	Cherry Tree	946.B.C.CZ
Pino	Pine	946.B.C.PN
Haya Blanca	Beech Tree	946.B.C.Y
Haya Vaporizada	Steam Beech	-

REF.
933.B.L.B
-
REF.
-
933.B.A.P
933.B.A.PM
REF.
-
-
-
-
-
-
REF.
-
-
-
-
-

85mm

KIT GUÍAS

TRACKS KIT

ADINOR

GS2B-GI5F

KIT GUÍA
TRACKS KIT

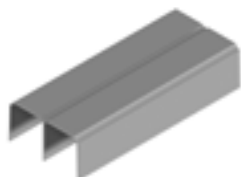

Ref. 111

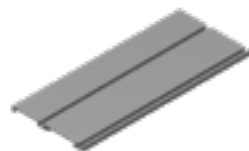

Ref. 137



Ref. 193

GS2B-GI2A

KIT GUÍA
TRACKS KIT

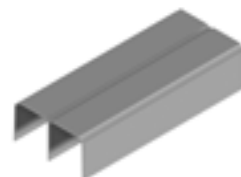

Ref. 111

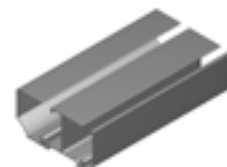

Ref. 121



Ref. 193

ACABADOS	FINISHINGS	2 m.	3 m.	4 m.	2 m.	3 m.	4 m.
LACADOS	COATED	REF.	REF.	REF.	REF.	REF.	REF.
Blanco Brillo Ral 9010	White	931.L.B.2	931.L.B.3	931.L.B.4	920.L.B.2	920.L.B.3	920.L.B.4
Negro Mate	Mat black	-	-	-	920.L.NM.2	920.L.NM.3	920.L.NM.4
ANODIZADOS	ANODIZED	REF.	REF.	REF.	REF.	REF.	REF.
Plata Brillo Repulido	Polished Silver	931.A.P.2	931.A.P.3	931.A.P.4	920.A.P.2	920.A.P.3	920.A.P.4
Plata Mate	Natural Anod.	931.A.PM.2	931.A.PM.3	931.A.PM.4	920.A.PM.2	920.A.PM.3	920.A.PM.4
MELAMINA	MELAMINE	REF.	REF.	REF.	REF.	REF.	REF.
Roble RO 444	Oak	931.M.RBRO.2	931.M.RBRO.3	931.M.RBRO.4	920.M.RBRO.2	920.M.RBRO.3	920.M.RBRO.4
Sapely Rameado	Sapely	931.M.SP.2	931.M.SP.3	931.M.SP.4	920.M.SP.2	920.M.SP.3	920.M.SP.4
Cerezo Duero	Cherry Tree	931.M.CZD.2	931.M.CZD.3	931.M.CZD.4	920.M.CZD.2	920.M.CZD.3	920.M.CZD.4
Haya Vapor 428	Steam Beech	931.M.YV.2	931.M.YV.3	931.M.YV.4	920.M.YV.2	920.M.YV.3	920.M.YV.4
Wengue Congo	Wengue	931.M.W.2	931.M.W.3	931.M.W.4	920.M.W.2	920.M.W.3	920.M.W.4
Blanco Rebamizable	White	931.M.MR.2	931.M.MR.3	931.M.MR.4	920.M.MR.2	920.M.MR.3	920.M.MR.4
MADERA	NATURAL WOOD	REF.	REF.	REF.	REF.	REF.	REF.
Roble Francés	Oak	931.C.RB.2	931.C.RB.3	931.C.RB.4	920.C.RB.2	920.C.RB.3	920.C.RB.4
Sapely	Sapely	931.C.SP.2	931.C.SP.3	931.C.SP.4	920.C.SP.2	920.C.SP.3	920.C.SP.4
Cerezo	Cherry Tree	931.C.CZ.2	931.C.CZ.3	931.C.CZ.4	920.C.CZ.2	920.C.CZ.3	920.C.CZ.4
Pino	Pine	931.C.PN.2	931.C.PN.3	931.C.PN.4	920.C.PN.2	920.C.PN.3	920.C.PN.4
Haya Blanca	Beech Tree	931.C.Y.2	931.C.Y.3	931.C.Y.4	920.C.Y.2	920.C.Y.3	920.C.Y.4
Haya Vaporizada	Steam Beech	931.C.YV.2	931.C.YV.3	931.C.YV.4	920.C.YV.2	920.C.YV.3	920.C.YV.4

85mm

INSTRUCCIONES DE MONTAJE

ASSEMBLY INSTRUCTIONS

ADINOR

ACCEDE AL PROGRAMA DE DESPIECE DE CADA SERIE EN:

www.adinor.info/programa-de-despiece

USE THE DOORS CUTTING SOFTWARE

Para solape según dibujo esquema

Doors superposed according to drawing

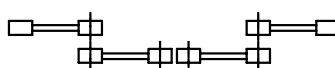

ALTURA PUERTA / DOOR HEIGHT

		SIN AMORTIGUADOR WITHOUT SELF CLOSING SYSTEM	CON AMORTIGUADOR WITH SELF CLOSING SYSTEM
		GS2B 	GS2B
GI2A		H - 65	H - 75
GI5F		H - 30	H - 40

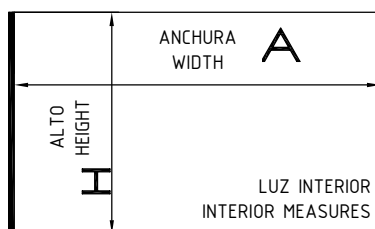

ANCHURA DEL TABLERO / BOARD WIDTH (C)

		TZM 16mm.	JP 16mm.	RTS 19mm.	MINS 16mm.	MINS 19mm.	MC 16mm.	FHP 16mm.	CT 80mm.	DB16mm.
2 PUERTAS	2 BOARDS	$\frac{A - 55}{2}$	$\frac{A - 5}{2}$	$\frac{A - 39}{2}$	$\frac{A - 14}{2}$	$\frac{A - 12}{2}$	$\frac{A - 15}{2}$	$\frac{A - 40}{2}$	$\frac{A - 20}{2}$	$\frac{A - 77}{2}$
3 PUERTAS	3 BOARDS	$\frac{A - 60}{3}$	$\frac{A + 5}{3}$	$\frac{A - 44}{3}$	$\frac{A - 14}{3}$	$\frac{A - 10}{3}$	$\frac{A - 5}{3}$	$\frac{A - 44}{3}$	$\frac{A + 10}{3}$	$\frac{A - 93}{3}$
4 PUERTAS	4 BOARDS	$\frac{A - 110}{4}$	$\frac{A - 10}{4}$	$\frac{A - 78}{4}$	$\frac{A - 28}{4}$	$\frac{A - 24}{4}$	$\frac{A - 30}{4}$	$\frac{A - 48}{4}$	$\frac{A - 40}{4}$	$\frac{A - 154}{4}$

LONGITUD CORTE PERFIL H, U / H, U PROFILE HEIGHT

TZM 16mm.	JP16mm.	RTS 19mm.	MINS 16mm.	MINS 19mm.	MC 16mm.	FHP 16mm.	CT 80mm.	DB16mm.
C - 34	C - 27	C - 21	C - 13	C - 16	C - 42	C - 27	C - 109	C - 28

SERIE 90

90 SERIE



SERIE 90

90 SERIE

ADINOR

GS90

GUÍA SUPERIOR GS90
GS90 UPPER RAIL

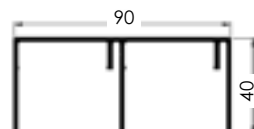

6m. Condiciones especiales de envío
6m. Special shipping conditions

ACABADOS	FINISHINGS	Longitud / Length : 6 m.
ANODIZADOS	ANODIZED	REF.
Plata Mate	Natural Anodized	119.A.PM

UGI

GUÍA INFERIOR UGI
UGI LOWER RAIL

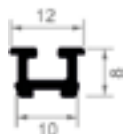

UGIP

GUÍA INFERIOR UGIP
UGIP LOWER RAIL



UGIA

GUÍA INFERIOR UGIA
UGIA LOWER RAIL



GIAE

GUÍA INFERIOR GIAE
GIAE LOWER RAIL

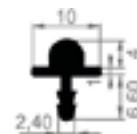

ACABADOS	FINISHINGS	Longitud / Length : 6 m.	Longitud / Length : 6 m.	Longitud / Length : 6 m.	Longitud / Length : 6 m.
LACADOS	COATED	REF.	REF.	REF.	REF.
Negro Mate	Mat Black	134.L.NM	-	-	-
Blanco Mate Ral9010	White Mat Ral9010	134.L.BM	-	-	-
ANODIZADOS	ANODIZED	REF.	REF.	REF.	REF.
Plata Mate	Natural Anodized	134.A.PM	124.A.PM	1341.A.PM	129.A.PM

COMPLEMENTOS

COMPLEMENTS

RODABLOC RR QUILLA

RR LOWER ROLLER



REF.	Descripción	Description
177	Rodabloc RR (Rueda Quilla) Guía Inferior UGI, UGIP	RR Lower Rail For UGI, UGIP Lower Rail

RODABLOC RR ACANALADA

RR LOWER ROLLER



REF.	Descripción	Description
176	Rodabloc RR (Rueda Acanalada) Guía Inferior GIAE, UGIA	RR Lower Rail For GIAE, UGIA Lower Rail

RODABLOC RR QUILLA BLOQUEO FRONTAL

RR LOWER ROLLER WITH FRONT LOCK



REF.	Descripción	Description
171	Rodabloc RR Bloqueo (Quilla) Guía Inferior GIO, GIEC, GI70, GI3P, UGIP, GI50, GI60	Front lock RR Lower Rail For GIO, GIEC, GI70, GI3P, UGIP, GI50, GI80 Lower Rail

CUÑA INFERIOR DE FRENO DOBLE PATILLA UGI, UGIP

UGI, UGIP BOTTOM STOPPER



REF.	Descripción	Description
1632	Freno para UGI, UGIP	UGI, UGIP Bottom stopper

CUÑA INFERIOR DE FRENO GIO, UGI, GI4F

GIO, UGI, GI4F BOTTOM STOPPER



REF.	Descripción	Description
1631	Freno para UGI, UGIP	UGI, UGIP Bottom stopper

CABALLETE METÁLICO CON COJINETES EXTRA Y GOMA S90

S80 METALLIC UPPER ROLLER WITH EXTRA BEARINGS



REF.	Descripción	Description
1629S90	CBSS90E (Con Cojinetes extra)	CBSS90E (With extra bearings)

AMORTIGUADOR DE CIERRE IZQ.+DCH. GS80 15 KG. (sistema montaje rápido)

LEFT & RIGHT SELF-CLOSING SYSTEM UP TO 15KG. (EASY ASSEMBLY)



REF.	
160S80AMOKIT15	x2

AMORTIGUADOR DE CIERRE IZQ.+DCH. GS80 25 KG. (sistema montaje rápido)

LEFT & RIGHT SELF-CLOSING SYSTEM UP TO 25KG. (EASY ASSEMBLY)



REF.	
160S80AMOKIT25	x2

AMORTIGUADOR DE CIERRE IZQ.+DCH. GS80 40 KG. (sistema montaje rápido)

LEFT & RIGHT SELF-CLOSING SYSTEM UP TO 40KG. (EASY ASSEMBLY)



REF.	
160S80AMOKIT40	x2

AMORTIGUADOR DE CIERRE IZQ.+DCH. GS80 60 KG. (sistema montaje rápido)

LEFT & RIGHT SELF-CLOSING SYSTEM UP TO 60KG. (EASY ASSEMBLY)



REF.	
160S80AMOKIT60	x2

AMORTIGUADOR DE CIERRE IZQ.+DCH. GS80 80 KG. (sistema montaje rápido)

LEFT & RIGHT SELF-CLOSING SYSTEM UP TO 80KG. (EASY ASSEMBLY)



REF.	
160S80AMOKIT80	x2

AMORTIGUADOR DE CIERRE CENTRAL GS80

GS80 CENTRAL SELF-CLOSING SYSTEM



REF.	Descripción	Description
160S80AMOKIT25	Amortiguador central 25 kg.	Central Self Closing System 25 kg.
160S80AMOKITC	Amortiguador central 40 kg.	Central Self Closing System 40 kg.

AMORTIGUADOR DE CIERRE IZQ.+DCH. GS80 100 KG. (sistema montaje rápido)

LEFT & RIGHT SELF-CLOSING SYSTEM UP TO 80KG. (EASY ASSEMBLY)



REF.	
160S80AMOKIT100	x2

AMORTIGUADOR DE CIERRE IZQ.+DCH. GS80 120 KG. (sistema montaje rápido)

LEFT & RIGHT SELF-CLOSING SYSTEM UP TO 80KG. (EASY ASSEMBLY)



REF.	
160S80AMOKIT120	x2

TAPÓN FINAL GUÍA UGIP

UGIP END COVER



REF.	Descripción	Description
1639	Tapón UGIP	UGIP End cover

CROQUIS DE MONTAJE

ASSEMBLY INSTRUCTIONS

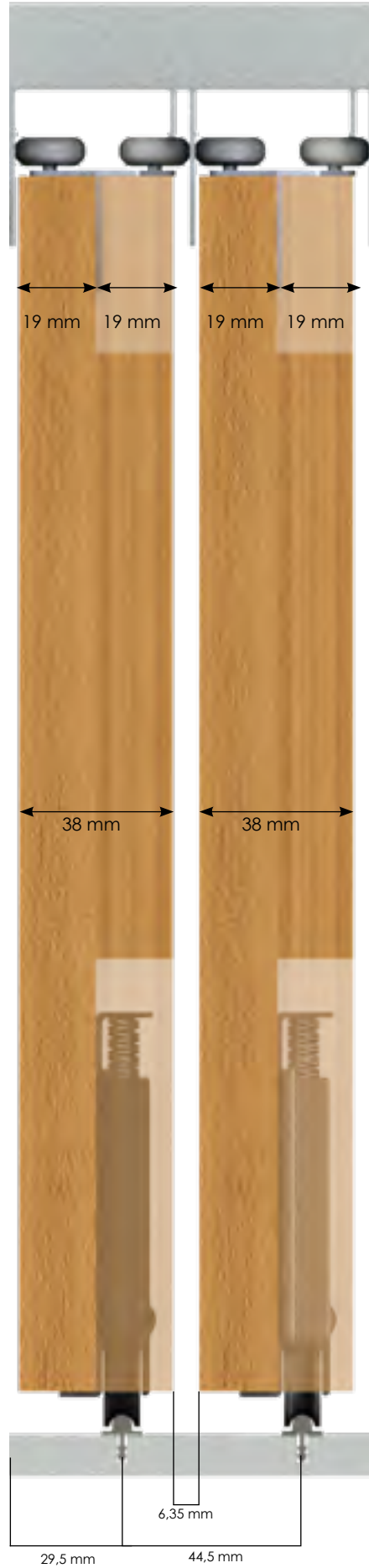
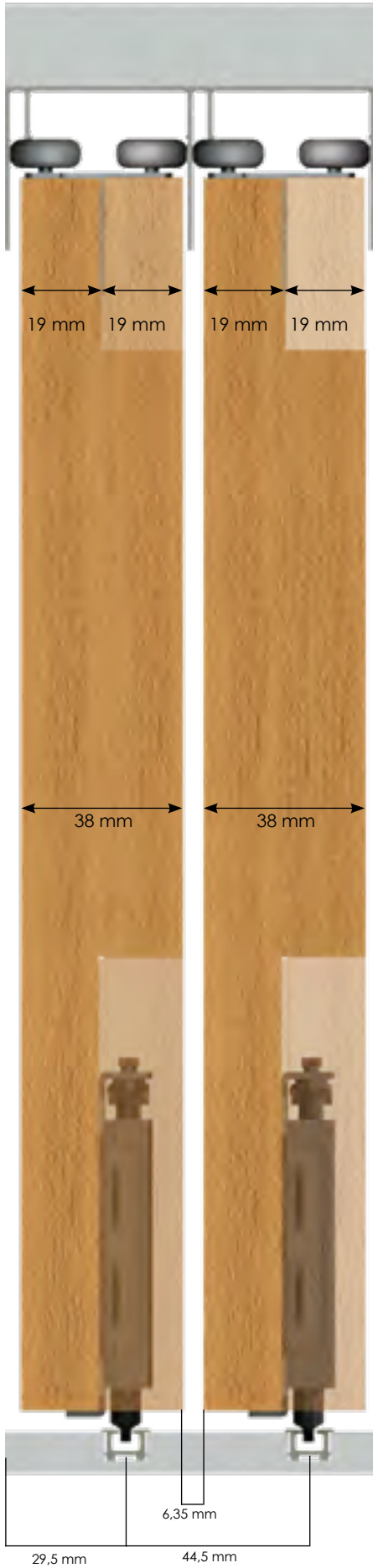

COMPLEMENTOS COMUNES

COMMON COMPLEMENTS



COMPLEMENTOS COMUNES SERIE M, S57, S70, S80, S85, S90

COMMON COMPLEMENTS FOR M, S57, S70, S80, S85, S90 SYSTEMS

FILM TEXTIL AUTOADHESIVO PARA VIDRIO

SELF-ADHESIVE GLASS PROTECTOR FABRIC



REF.	Medida / Measure
1519	Rollos / Roll 0,5 x 20m
1519DB	Rollos / Roll 1 x 20m

PIEZA DE ANCLAJE GI70, GI3P

LOWER RAIL FIXING PLATE GI70, GI3P



REF.
196

PIEZA DE ANCLAJE GI20, GI2A, GI2A80, GI5F, GI80, GI83, GI803P, BATIENTE 70x12, 80x12

LOWER RAIL FIXING PLATE GI20, GI2A, GI2A80, GI5F, GI80, GI83, GI803P, DOOR STOP MOULDING 70x12, 80x12



REF.
193

ARANDELA NYLON NIVELADORA

LEVELLING NYLON WASHER

PARA TIRADOR MIN10, MINS10-16 Y MSE16
FOR MIN10, MINS10-16 AND MSE16 HANDLE PROFILE



REF.
C530

CUÑA ANTICABECEO PARA TIRADOR MIN10, MINS10, MINS16, MSE16.

PVC STABILIZATION WEDGE FOR MINI10, MINS10, MINS16, MSE16 HANDLE PROFILE



REF.
C540

TORNILLOS

SCREWS



REF.	Medida / Measure	
HT6.5	3,9 x 6,5 mm.	16 un.
HT12	3,9 x 12 mm.	16 un.

CUÑA SUPERIOR DE FRENO

UPPER STOPPER



REF.	Descripción	Description
163	Guía Superior GSO, GSU, GSEC, GS57, GS80	GSO, GSU, GSEC, GS57, GS80 Upper Rail

CERRADURA PUERTAS CORREDERAS

SLIDING DOOR LOCK



PARA TABLERO DE 10, 16, 18, 19 mm
FOR 10, 16, 18, 19mm BOARD

REF.	Descripción	Description
17099.LLI	LLaves iguales	Equal keys
17099.LLD	LLaves diferentes	Different keys

CERRADURA FALLEBA PUERTAS CORREDERAS

SLIDING DOOR LOCK



PARA TABLERO DE 10, 16, 18, 19 mm
FOR 10, 16, 18, 19mm BOARD

REF.	Descripción	Description
17091	Cerradura Falleba	Falleba Lock

CEPILLO (Rollos)

BRUSH (Roll)

MARRÓN / BROWN		BLANCO / WHITE		GRIS / GREY	
REF.	MEDIDA / MEASURE	REF.	MEDIDA / MEASURE	REF.	MEDIDA / MEASURE
16080M	7 x 8 mm.	16060B	7 x 6 mm.	16140C	4 x 6 mm.
		16080B	7 x 8 mm.	16160	5 x 6 mm.
		16010B	7 x 10 mm.	16045	7 x 4,5 mm.
				16060	7 x 6 mm.
				16080	7 x 8 mm.
				16010	7 x 10 mm.
				16060AD	7 x 6 mm.
				16010AD	7 x 10 mm.



CEPILLO (Bolsa)

BRUSH (Poly Bag)



REF.	MEDIDA / MEASURE	BOLSA / POLY BAG
16060.K.G	7 x 6 mm. Gris / Grey	5,4 m
16060.K.B	7 x 6 mm. Blanco / White	5,4 m
16010C.K.G	7 x 10 mm. Gris / Grey	2,8 m
16010C.K.B	7 x 10 mm. Blanco / White	2,8 m
16140.K.G	4 x 6 Gris / Grey	5,4 m

6m. Condiciones especiales de envío
6m. Special shipping conditions

15x15

ÁNGULO 15x15
ANGLE PROFILE 15x15



U16mm.

U PARA TABLERO 16mm.
16mm. U PROFILE BOARD

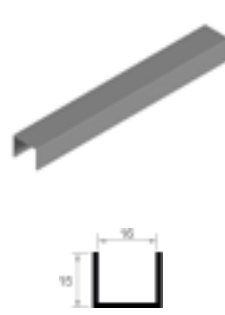

H16mm.

H PARA TABLERO 16mm.
16mm. H PROFILE BOARD

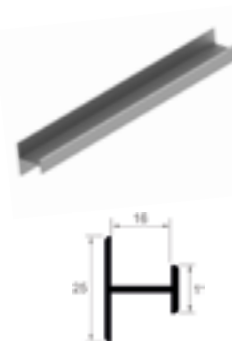

H16mm. (24X30)

H PARA TABLERO 16mm.(24X30)
16mm. H PROFILE BOARD (24X30)

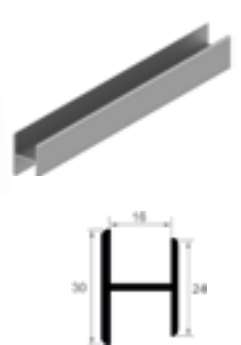

ACABADOS	FINISHINGS	Longitud / Length : 6 m.	Longitud / Length : 6 m.	Longitud / Length : 3 m.	Longitud / Length : 3 m.
LACADOS	COATED	REF.	REF.	REF.	REF.
Blanco Brillo Ral 9010	White	150.L.B	152.L.B	1525.L.B	C320.L.B
Negro Mate	Mat Black	-	152.L.NM	1525.L.NM	-
Blanco Mate Ral 9010	Mat white	-	152.L.BM	1525.L.BM	-
Blanco Mate Ral 9003	Mat white	-	152.L.BM03	1525.L.BM03	-
Antracita	Anthracite	-	152.L.ANT	1525.L.ANT	-
Oro	Gold	-	152.L.O	1525.L.O	-
ANODIZADOS	ANODIZED	REF.	REF.	REF.	REF.
Bronce Brillo Repulido	Bronce	-	152.A.BR	1525.A.BR	-
Plata Brillo Repulido	Polished Silver	-	152.A.P	1525.A.P	C320.A.P
Plata Mate	Natural Anodized	150.A.PM	152.A.PM	1525.A.PM	C320.A.PM
Inox Brillo Repulido	Inox	-	152.A.X	1525.A.X	-
MELAMINA	MELAMINE	REF.	REF.	REF.	REF.
Roble RO 444	Oak	-	152.M.RBRO	1525.M.RBRO	-
Roble 562	Oak	-	152.M.RB562	1525.M.RB562	-
Sapely D2517	Sapely	-	152.M.SPD	1525.M.SPD	-
Sapely Rameado	Sapely	-	152.M.SP	1525.M.SP	-
Cerezo Duero	Cherry Tree	-	152.M.CZD	1525.M.CZD	-
Cerezo Tajo	Cherry Tree	-	152.M.CZT	1525.M.CZT	-
Nogal Montisa	Montisa Walnut	-	152.M.NG	1525.M.NG	-
Haya Blanca Almijara	Beech Tree	-	152.M.Y	1525.M.Y	-
Haya Vapor. 428	Steam Beech	-	152.M.YV	1525.M.YV	-
Wengue Congo	Wengue	-	152.M.W	1525.M.W	-
Blanco Rebornizable	White	-	152.M.MR	1525.M.MR	-
Textil Coral	Textil Coral	-	-	-	-
Textil Cancun	Textil Cancun	-	152.M.TXCANC	1525.M.TXCANC	-
MADERA	NATURAL WOOD	REF.	REF.	REF.	REF.
Roble Francés	Oak	-	152.C.RB	1525.C.RB	-
Sapely	Sapely	-	152.C.SP	1525.C.SP	-
Cerezo	Cherry Tree	-	152.C.CZ	1525.C.CZ	-
Pino	Pine	-	152.C.PN	1525.C.PN	-
Haya Blanca	Beech Tree	-	152.C.Y	1525.C.Y	-
Haya Vaporizada	Steam Beech	-	152.C.YV	1525.C.YV	-
VINILO	VINYL	REF.	REF.	REF.	REF.
Blanco Sil	Blanco Sil	-	152.V.BS	1525.V.BS	-
Blanco Perla Touch	Blanco Perla Touch	-	152.V.BP	1525.V.BP	-
Blanco RAL 9003	Blanco RAL 9003	-	152.V.9003	1525.V.9003	-
Halifax Natural	Natural Halifax	-	152.V.HN	1525.V.HN	-
Halifax Tabaco	Tabaco Halifax	-	152.V.HT	1525.V.HT	-
Halifax Blanco	White Halifax	-	152.V.HB	1525.V.HB	-
Wengue Duero	Wengue Duero	-	152.V.W	1525.V.W	-
Palo Rosa Touch	Palo Rosa Touch	-	152.V.PRT	1525.V.PRT	-

HGA 16mm.

HGA 16mm.
16mm. H PROFILE BOARD

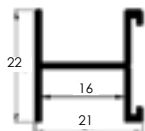

U10mm.

U PARA TABLERO 10mm.
10mm. U PROFILE BOARD

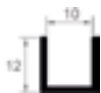

H10mm.

H PARA TABLERO 10mm.
10mm. H PROFILE BOARD



U18-10mm.

U PARA TABLERO 18-10mm.
18-10mm. U PROFILE BOARD



U18mm.

U PARA TABLERO 18mm.
18mm. U PROFILE BOARD

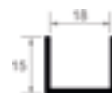

H18mm.

H PARA TABLERO 18mm.
18mm. U PROFILE BOARD



Longitud / Length : 3 m.	Longitud / Length : 6 m.	Longitud / Length : 3 m.	Longitud / Length : 6 m.	Longitud / Length : 6 m.	Longitud / Length : 3 m.
REF.	REF.	REF.	REF.	REF.	REF.
-	151.L.B	1515.L.B	-	154.L.B	1589.L.B
-	151.L.NM	1515.L.NM	-	154.L.NM	1589.L.NM
-	151.L.BM	1515.L.BM	-	-	-
-	151.L.BM03	1515.L.BM03	-	154.L.BM03	1589.L.BM03
-	-	-	-	154.L.ANT	1589.L.ANT
-	151.L.O	1515.L.O	-	-	1589.L.O
REF.	REF.	REF.	REF.	REF.	REF.
-	151.A.BR	1515.A.BR	-	154.A.BR	1589.A.BR
-	151.A.P	1515.A.P	-	-	-
146H.A.PM	151A.PM	1515.A.PM	1548.A.PM	154.A.PM	1589.A.PM
-	151.A.X	1515.A.X	-	154.A.X	-
REF.	REF.	REF.	REF.	REF.	REF.
-	151.M.RBRO	1515.M.RBRO	-	154.M.RBRO	1589.M.RBRO
-	151.M.RB562	1515.M.RB562	-	-	-
-	151.M.SPD	1515.M.SPD	-	-	-
-	-	-	-	-	-
-	151.M.CZD	1515.M.CZD	-	-	-
-	151.M.CZT	1515.M.CZT	-	-	-
-	-	-	-	-	-
-	151.M.Y	1515.M.Y	-	-	-
-	151.M.YV	1515.M.YV	-	-	-
-	151.M.W	1515.M.W	-	154.M.W	1589.M.W
-	151.M.MR	1515.M.MR	-	154.M.MR	1589.M.MR
-	151.M.TXCO	-	-	-	-
-	-	-	-	-	-
REF.	REF.	REF.	REF.	REF.	REF.
-	151.C.RB	1515.C.RB	-	154.C.RB	1589.C.RB
-	151.C.SP	1515.C.SP	-	-	-
-	151.C.CZ	1515.C.CZ	-	-	-
-	151.C.PN	1515.C.PN	-	-	-
-	151.C.Y	1515.C.Y	-	-	-
-	151.C.YV	1515.C.YV	-	-	-
REF.	REF.	REF.	REF.	REF.	REF.
-	151.V.BS	1515.V.BS	-	-	-
-	151.V.BP	1515.V.BP	-	-	-
-	151.V.9003	1515.V.9003	-	-	-
-	151.V.HN	1515.V.HN	-	-	-
-	151.V.HT	1515.V.HT	-	-	-
-	151.V.HB	1515.V.HB	-	-	-
-	151.V.VW	1515.V.VW	-	-	-
-	151.V.PRT	1515.V.PRT	-	-	-

U19mm.
U PARA TABLERO 19mm.
 19mm. U PROFILE BOARD

H19mm.
H PARA TABLERO 19mm.
 19mm. H PROFILE BOARD

PLETINA5x2
PLETINA PVC ADHESIVA
 PVC SELF-ADHESIVE PLATE

PLETINA8x2
PLETINA PVC ADHESIVA
 PVC SELF-ADHESIVE PLATE

6m. Condiciones especiales de envío
6m. Special shipping conditions

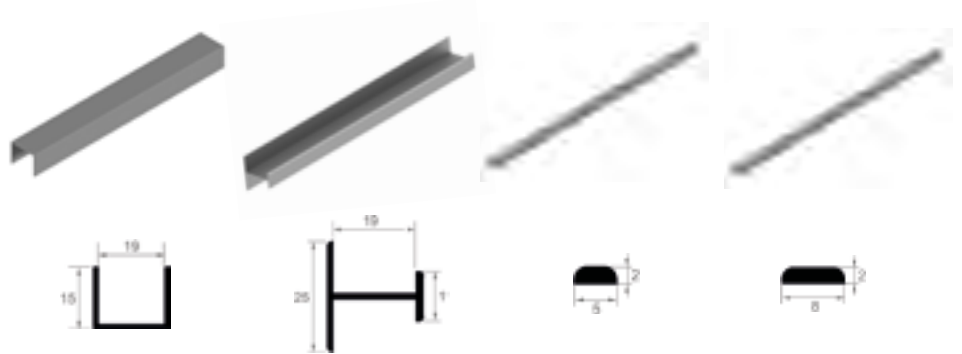

ACABADOS	FINISHINGS	Longitud / Lenght : 6 m.	Longitud / Lenght : 3 m.	Longitud / Lenght : 3 m.	Longitud / Lenght : 3 m.
LACADOS	COATED	REF.	REF.	REF.	REF.
Blanco Brillo Ral 9010	White	1522.L.B	1580.L.B	-	-
Blanco Mate Ral 9010	Mat white	1522.L.BM	1580.L.BM	-	-
Blanco Mate Ral 9003	Mat white	1522.L.BM03	1580.L.BM03	-	-
Negro Mate	Black	1522.L.NM	1580.L.NM	-	-
Antracita	Anthracite	1522.L.ANT	1580.L.ANT	-	-
Oro	Gold	-	-	-	-
ANODIZADOS	ANODIZED	REF.	REF.	REF.	REF.
Plata Brillo Repulido	Polished Silver	1522.A.P	1580.A.P	-	-
Plata Mate	Natural Anodized	1522.A.PM	1580.A.PM	453.A.PM	4531.A.PM
Crudo	Natural	-	-	-	-
MELAMINA	MELAMINE	REF.	REF.	REF.	REF.
Blanco Rebarnizable	White	1522.M.MR	1580.M.MR	-	-
MADERA	NATURAL WOOD	REF.	REF.	REF.	REF.
Roble Francés	Oak	1522.C.RB	1580.C.RB	-	-
Cerezo	Cherry Tree	1522.C.CZ	1580.C.CZ	-	-

GOMA 4-5mm.
TRANSPARENTE PARA
CRISTAL 4-5mm.
 TRANSPARENT GASKET

TIRA BURBUJA
TIRA BURBUJA LATERAL
TIRADOR CRVO 10mm
 PVC LATERAL GASKET
 FOR CRVO 10mm HANDLE
 PROFILE

GOMA 5mm.
TRANSPARENTE PARA
CRISTAL 5mm.
 TRANSPARENT GASKET

GOMA 4mm.
TRANSPARENTE PARA
CRISTAL 4mm.
 TRANSPARENT GASKET

Vidrio = 4-5 mm.
 Glassy

Vidrio = 5 mm.
 Glassy

Vidrio = 4 mm.
 Glassy

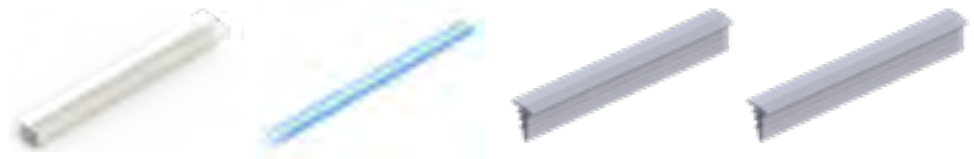

PARA TIRADOR 19mm.
 19mm. HANDLE PROFILE

PARA TIRADOR 10mm.
 10mm. HANDLE PROFILE

PARA TIRADOR 10mm.
 10mm. HANDLE PROFILE

ACABADOS	FINISHINGS	Rollo / Roll: 25 m.	Rollo / Roll: 250 m.	Rollo / Roll: 150 m.	Rollo / Roll: 125 m.
ACABADOS	FINISHINGS	REF.	REF.	REF.	REF.
Transparente	Transparent	15892	751	1585	1586
Gris	Grey	-	-	-	-

PLETINA 20x2 PERFIL T7,5mm. PLETINA 40x2,5

PLETINA ALUMINIO
DECORATIVA
ALUMINIUM PLATE

PERFIL T ALUMINIO
ALUMINIUM T PROFILE

PLETINA DE ALUMINIO
ALUMINIUM PLATE

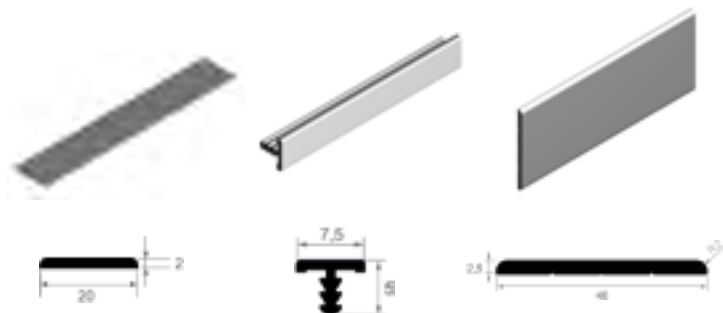

Longitud / Lenght : 6 m.	Longitud / Lenght : 6 m.	Longitud / Lenght : 6 m.
REF.	REF.	REF.
157.L.B	-	-
-	-	-
-	-	-
157.L.O	-	-
REF.	REF.	REF.
157.A.P	-	-
157.A.PM	454.A.PM	-
-	-	1575.A.C
REF.	REF.	REF.
-	-	-
REF.	REF.	REF.
-	-	-
-	-	-

GOMA 4-5mm.

TRANSPARENTE PARA
CRISTAL 4-5mm.
TRANSPARENT GASKET

GOMA 4-5mm.

TRANSPARENTE PARA
CRISTAL 4-5mm.
TRANSPARENT GASKET

REDUCTOR 16mm.

PERFIL PVC REDUCTOR
SLOT REDUCER PROFILE

REDUCTOR 10mm.

PERFIL PVC REDUCTOR
SLOT REDUCER PROFILE

REDUCTOR 18mm.

PERFIL PVC REDUCTOR
SLOT REDUCER PROFILE

Vidrio
Glassy = 4-5 mm.

Vidrio
Glassy = 4-5 mm.

Vidrio
Glassy = 4-5 mm.

Vidrio
Glassy = 4 mm.

Vidrio
Glassy = 4-6 mm.



PARA TIRADOR 16mm.
16mm. HANDLE PROFILE

PARA TIRADOR 18mm.
18mm. HANDLE PROFILE

PARA TIRADOR 16mm.
16mm. HANDLE PROFILE

PARA TIRADOR 10mm.
10mm. HANDLE PROFILE

PARA TIRADOR 18mm.
18mm. HANDLE PROFILE

Rollo / Roll: 50 m.	Rollo / Roll: 50 m.	Longitud / Lenght : 3 m.	Longitud / Lenght : 3 m.	Longitud / Lenght : 3 m.
REF.	REF.	REF.	REF.	REF.
1587	15891	-	-	15835
-	-	1583	1584	-



PUERTAS ABATIBLES Y PLEGABLES

FOLDING AND BIFOLDING DOOR SYSTEMS

ABATIBLES VIDRIO
FOLDING GLASS DOORS

114

ABATIBLES
BIFOLDING DOORS

116

PLEGABLES
BIFOLDING DOORS

123

ABATIBLES VIDRIO FOLDING DOORS



KIT PUERTA

ABATIBLES

VIDRIO

KIT GLASS FOLDING DOORS

ADINOR

20x45 P8

PERFIL 20x45 P8
20x45 P8 PROFILE

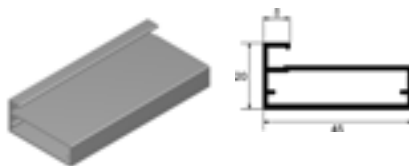

PUERTA ALUMINIO HASTA 2000x550mm
(4 mecanizados bisagra)
ALUMINIUM FRAME DOOR UP TO 2000x550mm (4 hinges drill)

PUERTA ALUMINIO HASTA 2500x550mm
(5 mecanizados bisagra)
ALUMINIUM FRAME DOOR UP TO 2500x550mm (5 hinges drill)

35x45 P8

PERFIL 35x45 P8
35x45 P8 PROFILE

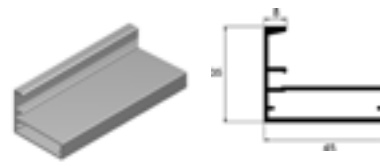

PUERTA ALUMINIO HASTA 2800x550mm
(6 mecanizados bisagra)
ALUMINIUM FRAME DOOR UP TO 2800x550mm (6 hinges drill)

ACABADOS	FINISHINGS	Longitud / Length : 2000x550 mm.	Longitud / Length : 2500x550 mm.	Longitud / Length : 2800x550 mm.
LACADOS	COATED	REF.	REF.	REF.
Negro Mate	Mat Black	7995KIT.L.NM.2	7995KIT.L.NM.25	7995KIT.L.NM.28
ANODIZADOS	ANODIZED	REF.	REF.	REF.
Plata Mate	Natural Anodized	7995KIT.A.PM.2	7995KIT.A.PM.25	7995KIT.A.PM.28

20x45 P4N

PERFIL 20x45mm
20x45mm PROFILE

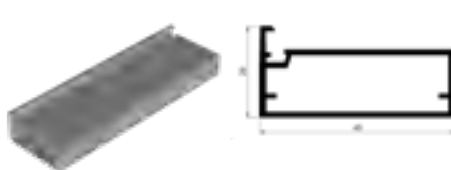

PUERTA ALUMINIO HASTA 2000x550mm
(4 mecanizados bisagra)
ALUMINIUM FRAME DOOR UP TO 2000x550mm (4 hinges drill)

PUERTA ALUMINIO HASTA 2500x550mm
(5 mecanizados bisagra)
ALUMINIUM FRAME DOOR UP TO 2500x550mm (5 hinges drill)

35x45 P4

PERFIL 35x45mm
35x45mm PROFILE

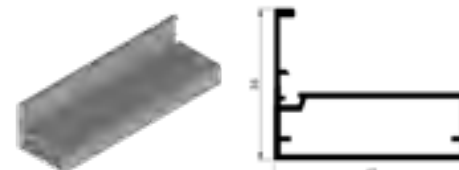

PUERTA ALUMINIO HASTA 2800x550mm
(6 mecanizados bisagra)
ALUMINIUM FRAME DOOR UP TO 2800x550mm (6 hinges drill)

ACABADOS	FINISHINGS	Longitud / Length : 2000x550 mm.	Longitud / Length : 2500x550 mm.	Longitud / Length : 2800x550 mm.
LACADOS	COATED	REF.	REF.	REF.
Negro Mate	Mat Black	7888KIT.L.NM.2	7888KIT.L.NM.25	7888KIT.L.NM.28
ANODIZADOS	ANODIZED	REF.	REF.	REF.
Plata Mate	Natural Anodized	7888KIT.A.PM.2	7888KIT.A.PM.25	7888KIT.A.PM.28

BISAGRA HETTICH BLACK RECTA / ACODADA / SUPERACODADA

OVERLAY / HALF OVERLAY / INSET MOUNTING / HETTICH BLACK HINGE



REF.
HBH12 (Recta)
HBH22 (Acodada)
HBH32 (Superacodada)

INCLUYE:
EMBELLECEDOR
CAZOLETA Y BRAZO

BASE AVIÓN HETTICH BLACK CON REGULACIÓN EXCÉNTRICA

HETTICH BLACK CLIP PLATE

H = 0



REF.
HBH41

BASE RECTA HETTICH BLACK

HETTICH BLACK CLIP PLATE

H = 0'5



REF.
HBH44

ABATIBLES

FOLDING DOORS



ABATIBLES BT60

BT60 FOLDING DOORS

ADINOR

BT60

TIRADOR BT60 10mm
10mm BT60 HANDLE PROFILE



H BT60

PERFIL H BT60 10mm
10mm BT60 H PROFILE



ACABADOS	FINISHINGS	Longitud / Length : 2,7 m.	Longitud / Length : 3 m.
LACADOS	COATED	REF.	REF.
Blanco Mate Ral 9010	Mat White Ral 9010	BT110.L.BM	BT210.L.BM
Negro Mate	Mat Black	BT110.L.NM	BT210.L.NM
ANODIZADOS	ANODIZED	REF.	REF.
Plata Mate	Natural Anodized	BT110.A.PM	BT210.A.PM
MELAMINA	MELAMINE	REF.	REF.
Roble RO 444	Oak	BT110.M.RBRO	BT210.M.RBRO
Textil Coral	Textil	BT110.M.TXCO	BT210.M.TXCO
Sapely D2517	Sapely	BT110.M.SPD	BT210.M.SPD
Haya Vapor. 428	Steam Beech	BT110.M.YV	BT210.M.YV
Blanco Rebornizable	White	BT110.M.MR	BT210.M.MR
MADERA	NATURAL WOOD	REF.	REF.
Roble Francés	Oak	BT110.C.RB	BT210.C.RB
Sapely	Sapely	BT110.C.SP	BT210.C.SP
Cerezo	Cherry Tree	BT110.C.CZ	BT210.C.CZ
Pino	Pine	BT110.C.PN	BT210.C.PN
Haya Blanca	Beech Tree	BT110.C.Y	BT210.C.Y
VINILO	VINYL	REF.	REF.
Blanco RAL 9003	Blanco RAL 9003	BT110.V.9003	BT210.V.9003

COMPLEMENTOS COMPLEMENTS

TENSOR UNIÓN TIRADOR BT60 CON H BT60

PERPENDICULAR JOINT



REF.

BT302

Bolsa 4un. / 4un Box

GOMA REDUCTORA VIDRIO 4mm. BT60

BT60 PLASTIC GASKET FOR 4mm. GLASS



REF.

BT303.4

Rollo / Roll: 100m

GOMA REDUCTORA VIDRIO 5mm. BT60

BT60 PLASTIC GASKET FOR 5mm. GLASS



REF.

BT303.5

Rollo / Roll: 100m

ABATIBLES BT10

BT10 FOLDING DOORS

ADINOR

VHBT10mm.
TIRADOR VHBT 10mm.
10mm. VHBT HANDLE PROFILE

HBT10mm.
PERFIL H BT 10mm.
10mm. BT H PROFILE

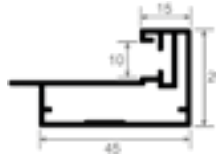
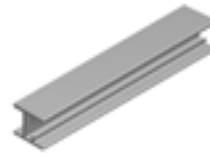
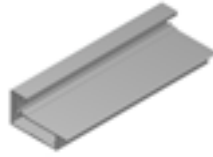

ACABADOS	FINISHINGS	Longitud / Length : 2,6 m.	Longitud / Length : 3 m.
LACADOS	COATED	REF.	REF.
Blanco Brillo Ral9010	White Ral9010	BT100.L.B	BT200.L.B
Negro Mate	Mat Black	BT100.L.NM	BT200.L.NM
ANODIZADOS	ANODIZED	REF.	REF.
Plata Brillo Repulido	Polished Silver	BT100.A.P	BT200.A.P
Plata Mate	Natural Anodized	BT100.A.PM	BT200.A.PM

COMPLEMENTOS COMPLEMENTS

ESCUADRA 42x42 PERFIL BT + 4 TORNILLOS

42X42 INNER CONNECTION ANGLE FOR BT + 4 SCREWS



REF.

BT300

ESCUADRA REMATE 42x5 PERFIL BT + 3 TORNILLOS

42X5 INNER CONNECTION ANGLE FOR BT+ 3 SCREWS



REF.

BT301

CONJUNTO 4 ESCUADRAS DE ZAMAK + 8 TORNILLOS

4 ZAMAK INNER CONNECTION ANGLE + 8 SCREWS



REF.

7932

BISAGRAS SALICE RECTA /ACODADA / SUPERACODADA

OVERLAY / HALF OVERLAY / INSET MOUNTING / SALICE HINGE

Espesor 19-35mm.
Thickness 19-35mm.



REF.

H12 (Recta)

H22 (Acodada)

H32 (Superacodada)

BASE SALICE CON REGULACIÓN

SALICE CLIP PLATE

H = 0



REF.

HS42

ABATIBLES BT10 KIT

BT10 SET

ADINOR

**KIT
BT10mm.**

**KIT DE PUERTA ABATIBLE
FOLDING DOOR KIT**

CORTE RECTO
STRAIGHT CUT

**KIT
BT10mm.**

**KIT DE PUERTA ABATIBLE
FOLDING DOOR KIT**

CORTE A INGLETE
MITRE CUT

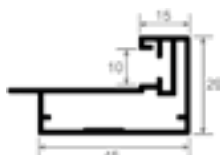
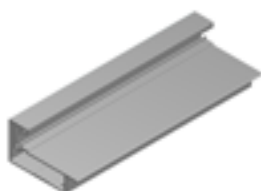

2x2,6m.

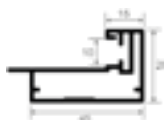

1,5m.



2un.



2un.



4un.



Mecanizados
Bisagra



2x2,6m.

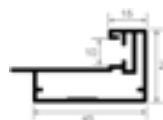

1m.



4un.



4un.



Mecanizados
Bisagra

ACABADOS

FINISHINGS

LACADOS

COATED

REF.

REF.

Blanco Brillo Ral 9010

White

BTK.CR.L.B

BTK.CI.L.B

Negro Mate

Mat Black

BTK.CR.L.NM

BTK.CI.L.NM

ANODIZADOS

ANODIZED

REF.

REF.

Plata Brillo Repulido

Polished Silver

BTK.CR.A.P

BTK.CI.A.P

Plata Mate

Natural Anodized

BTK.CR.A.PM

BTK.CI.A.PM

ABATIBLES COMPLEMENTOS

FOLDING DOORS
COMPLEMENTS

ADINOR

TIRADOR 37x16

TIRADOR 37x16
37x16 HANDLE PROFILE

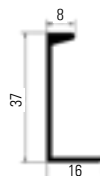

TIRADOR 48x14

TIRADOR 48x14
48x14 HANDLE PROFILE



PARA PERFIL TIRADOR BT10
FOR BT10 HANDLE PROFILE

6m. Condiciones especiales de envío
6m. Special shipping conditions

ACABADOS	FINISHINGS	Longitud / Length : 5 m.	Longitud / Length : 150 mm.	Longitud / Length : 5,2 m.
LACADOS	COATED	REF.	REF.	REF.
Blanco	White	7997.L.B	7997.L.B.150	7794.L.B.52
Negro Mate	Mat Black	7997.L.NM	7997.L.NM.150	7794.L.NM.52
ANODIZADOS	ANODIZED	REF.	REF.	REF.
Plata Brillo	Polished Silver	7997.A.P	-	7794.A.P.52
Plata Mate	Natural Anodized	7997.A.PM	7997.A.PM.150	7794.A.PM.52

TIRADOR J

TIRADOR J
J HANDLE PROFILE

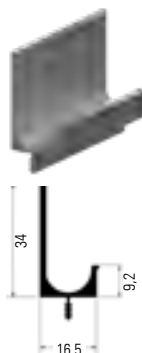

TIRADOR GOLA AIR

TIRADOR GOLA AIR
GOLA AIR HANDLE PROFILE

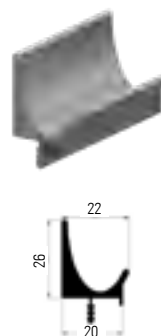

CANTONERA

CANTONERA CRVIR
CRVIR BORDER PROFILE

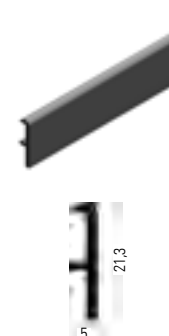

CANTONERA

CANTONERA AAR
AAR BORDER PROFILE

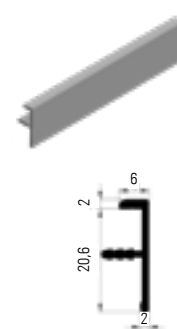

ACABADOS	FINISHINGS	Longitud / Length : 6 m.	Longitud / Length : 4 m.	Longitud / Length : 4m.	Longitud / Length : 5,2 m.
LACADOS	COATED	REF.	REF.	REF.	REF.
Blanco Mate RAL 9003	Mat White RAL9003	-	-	-	79929.L.BM03
Negro Mate	Mat Black	-	-	-	79929.L.NM
Repintable	Pre-paint	-	710.IROD.A.T	-	-
ANODIZADOS	ANODIZED	REF.	REF.	REF.	REF.
Plata Brillo	Polished Silver	-	-	-	-
Plata Mate	Natural Anodized	710.A.PM	710.IROD.PM	79921.A.PM	79929.A.PM



TIRADOR GOLA

TIRADOR GOLA
GOLA HANDLE PROFILE

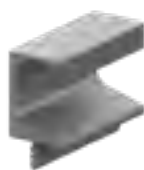

Longitud / Length : 5,2 m.

REF.

7294.L.BM03.52

7294.L.NM.52

7294.L.T.52

REF.

7294.A.PM.52

TIRADOR HORIZON

TIRADOR HORIZON
HORIZON HANDLE PROFILE

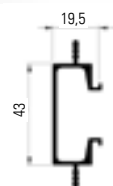

Longitud / Length : 4 m.

REF.

7291.L.BM03.4

7291.L.NM.4

7291.L.T.4

REF.

7291.PM.4

TAPA HORIZON

TAPA HORIZON
HORIZON END COVER



IZQ+DER / RIGHT+LEFT

REF.

7291TL.L.BM03

7291TL.L.NM

7291TL.L.T

REF.

7291TL.L.PM

ACABADOS

FINISHINGS

LACADOS

COATED

Blanco Mate RAL 9003

Mat White RAL 9003

Negro Mate

Mat Black

Repintable

Pre-paint

ANODIZADOS

ANODIZED

Plata Mate

Natural Anodized

PLETINA 5x2

PLETINA ADHESIVA
SELF-ADHESIVE PLATE



Longitud / Length : 3 m.

REF.

453.A.PM

PLETINA 8x2

PLETINA ADHESIVA
SELF-ADHESIVE PLATE



Longitud / Length : 3 m.

REF.

4531.A.PM

PERFIL T 7,5mm.

PERFIL T
T PROFILE



Longitud / Length : 6 m.

REF.

454.A.PM

ACABADOS

FINISHINGS

ANODIZADOS

ANODIZED

Plata Mate

Natural Anodized

TIRADOR SENSE ALUMINIO

SENSE ALUMINIUM HANDLE



El perfil de aluminio viene con un tratamiento para poderlo lacar en el color deseado.

Medida del tirador desde 150 mm. hasta 3000 mm.

The aluminium profile has an special treatment that allows you to paint it in any colour wished.

Lenght of the handle: 150 mm. to 3000 mm.

REF.	DESCRIPCION / DESCRIPTION
SKPA.4295464	Kit perfil 1 m. + 2 bisagras / 1 m. handle set + 2 hinges
SKPA.4585464	Kit perfil 3 m. + 6 bisagras / 3 m. handle set + 6 hinges
SKPA.5685464	Bisagra para tirador Sense / Sense Hinge handle

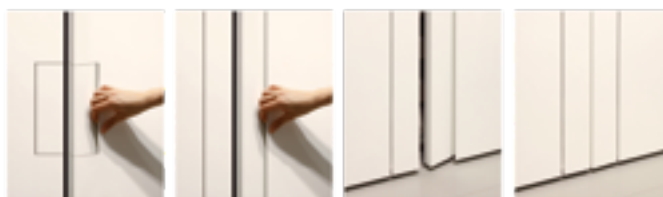

COMPLEMENTOS

COMPLEMENTS

BISAGRA RECTA/ACODADA/SUPERACODADA CON SOFT CLOSING

110° / HALF OVERLAY / INSET MOUNTING SOFT CLOSING HINGE



REF.
H15.PL.R
H25.PL.A
H35.PL.SA

BISAGRA RECTA/ACODADA/SUPERACODADA CON SOFT CLOSING

165° / HALF OVERLAY / INSET MOUNTING SOFT CLOSING HINGE



REF.
H45.PL.165R
H45.PL.165A
H45.PL.165SA

BASE CON REGULACIÓN PARA TABLERO.

CLIP PLATE FOR BOARD

H=0



ESPESOR TABLERO / DOOR HEIGHT	REF.
19mm	H55.PL.19
16mm	H55.PL.16

BISAGRA MASTER BLACK RECTA / ACODADA / SUPERACODADA CON SOFT CLOSING

OVERLAY / HALF OVERLAY / INSET MOUNTING SOFT CLOSING MASTER BLACK HINGE



REF.
HBSA12 (Recta)
HBSA22 (Acodada)
HBSA32 (Superacodada)

INCLUYE:
EMBELLEDADOR
CAZOLETA Y BRAZO

BASE AVIÓN MASTER BLACK CON REGULACIÓN EXCÉNTRICA

MASTER BLACK CLIP PLATE

Tablero 19 mm



REF.
HBSA41

BASE RECTA MASTER BLACK

MASTER BLACK CLIP PLATE - HORIZONTAL

Tablero 19 mm



REF.
HBSA44

PLEGABLES

BIFOLDING DOORS

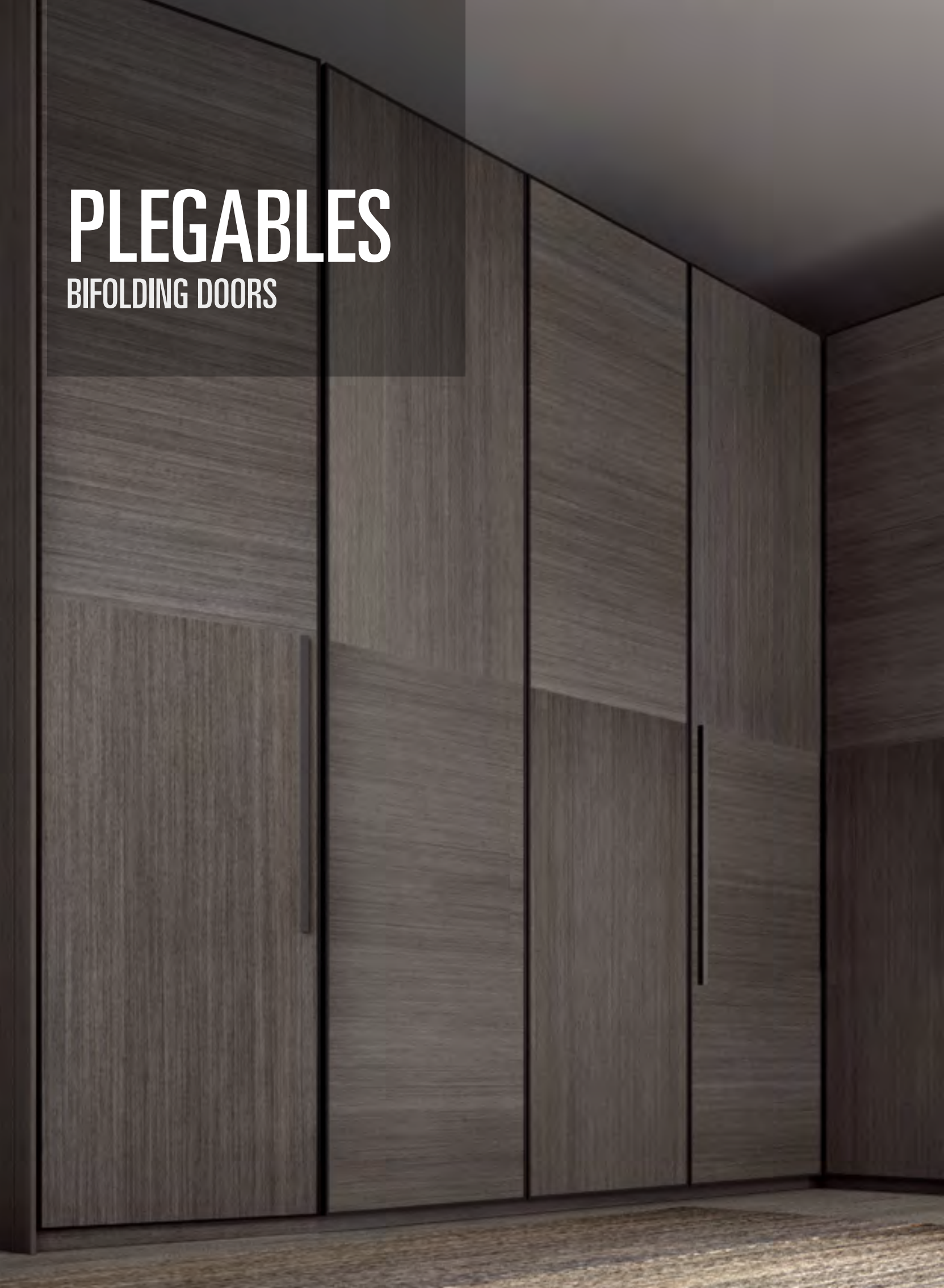

PLEGABLES

BIFOLDING DOORS

ADINOR

6m. Condiciones especiales de envío
6m. Special shipping conditions

GUIA SUPERIOR ALUMINIO

UPPER RAIL



Longitud / Length : 6 m.

REF.	LACADOS	COATED
PL112.L.B.6	Blanco	White
REF.	ANODIZADOS	ANODIZED
PL111.A.PM.6	Plata Mate	Natural Anod.

GUIA INFERIOR ALUMINIO

LOWER RAIL



Longitud / Length : 6 m.

REF.	LACADOS	COATED
PL122.L.B.6	Blanco	White
REF.	ANODIZADOS	ANODIZED
PL121.A.PM.6	Plata Mate	Natural Anod.

CARRO SUPERIOR

UPPER ROLLER



REF.

PL130

CARRO INFERIOR

BOTTOM ROLLER

REVERSIBLE / REVERSIBLE



REF.

PL140

CONJUNTO 4 BISAGRAS PUERTA PLEGABLE + 8 CLIPS

SET OF 4 CLIP-ON CENTRE HINGES



REF.

PL160

FIJACION CARRO SUPERIOR CON REGULACIÓN

SUPPORT WITH HEIGHT-ADJUSTMENT CAPABILITY

REVERSIBLE / REVERSIBLE



REF.

PL153

DESCRIPCION

Derecha /Izquierda

DESCRIPTION

Right / Left

DISTANCIADOR PARA PLEGABLE CORREDERA

SPACER SPINDLE FOR SLIDING FOLDING DOOR



REF.

PL170

PLEGABLES KIT

BIFOLDING DOOR SET

ADINOR

KIT PARA 1 PUERTA PLEGABLE (2 HOJAS)

KIT FOR 1 FOLDING DOOR WITH 2 PANELS

REVERSIBLE / REVERSIBLE



REF.	DESCRIPCION	DESCRIPTION
PL180	Derecha /Izquierda	Right / Left

KIT PARA 1 PUERTA PLEGABLE CORREDERA (2 HOJAS)

KIT FOR 1 SLIDING FOLDING DOOR WITH 2 PANELS

REVERSIBLE / REVERSIBLE



REF.	DESCRIPCION	DESCRIPTION
PL185	Derecha /Izquierda	Right / Left

INSTRUCCIONES
DE MONTAJE
ASSEMBLY INSTRUCTIONS

DESCÁRGATE LAS INSTRUCCIONES COMPLETAS EN:
www.adinor.info/instrucciones-de-montaje

DOWNLOAD THE COMPLETE ASSEMBLY INSTRUCTIONS
www.adinor.info/instrucciones-de-montaje



SISTEMAS MODULARES

MODULAR SYSTEMS

COLOMA

128

UNIX

147

DOMINÓ

155

ABP

163

SISTEMA STRUKTURA 165

SISTEMA COLOMA

COLOMA SYSTEM















CONCEPTO FUNCIONAL

Este tipo de construcción permite crear espacios de gran amplitud visual pudiendo exponer los productos de una manera atractiva y sencilla.

Conjunto de paneles y baldas soportados mediante perfiles ocultos de aluminio atornillados a la pared.

Su diseño permite regular las baldas a la altura deseada gracias a la cremallera que incorporan los perfiles.

Las baldas a utilizar son de 30-40 mm de grosor y los paneles traseros pueden tener un espesor de 10 a 30 mm.

El ancho máximo recomendado por módulo es 1,30 m.

La altura máxima del perfil básico es 2,80 m.

El peso máximo recomendado por balda es 50 kg.

El grosor estándar del panel trasero es 10 mm.

SUMMARY

This system creates a model of visual spaciousness being able to display the products in an alternative and simple way.

A collection of panels and shelves supported by slotted aluminium profiles fixed to the wall that remain completely concealed and permit shelf regulation to the desired height.

The shelves thickness is 30-40 mm. and is intended for backing panel thickness from 10 to 30 mm.

The maximum recommended panel width is 1,30 m.

The basic profile maximum height is 2,80 m.

The maximum weight recommended per panel is 50 kg.

The back panel standard thickness is 10 mm.

COLOMA

ADINOR

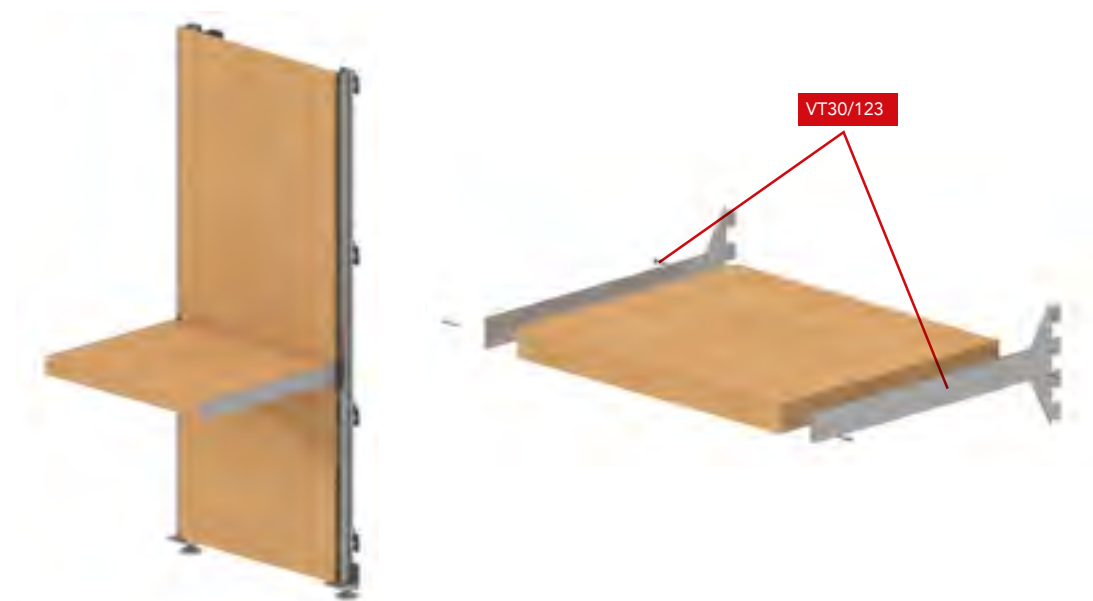

PERFIL BÁSICO V1

SLOTTED BASIC PROFILE

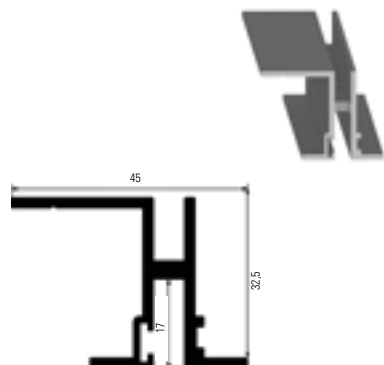

REF.
V100.A.N

Longitud / Length : **2,8 m.**

PERFIL BÁSICO V3

SLOTTED BASIC PROFILE

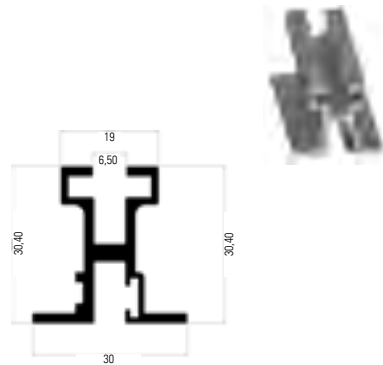

REF.
V102.A.N

Longitud / Length : **2,8 m.**

Corte profundidad balda / Depth shelf measure:

MODELO PERFIL SLOTTED PROFILE	Espesor panel trasero Backing pannel thickness	Cartela 543 mm Shelf Bracket	Cartela 350 mm Shelf Bracket
V1	10 mm	543 mm	350 mm
	16 mm	537 mm	344 mm
	19 mm	534 mm	341 mm
V3	10 mm	548 mm	355 mm
	16 mm	542 mm	349 mm
	19 mm	539 mm	346 mm

NO VÁLIDO PARA: "CARTELAS PARA ATORNILLAR
MODELO USA"

Corte anchura balda / Shelf width measure:

misma anchura que el panel trasero
Same width as backing pannel

COMPONENTES COMPONENTS

SOPORTE FIJACIÓN PARED SIMPLE

SINGLE WALL FIXING ANGLE



REF.
V107

Sólo válido para el Perfil Básico V3
Only for the slotted, V3 Basic Profile

SOPORTE FIJACIÓN PARED DOBLE

DOUBLE WALL FIXING ANGLE

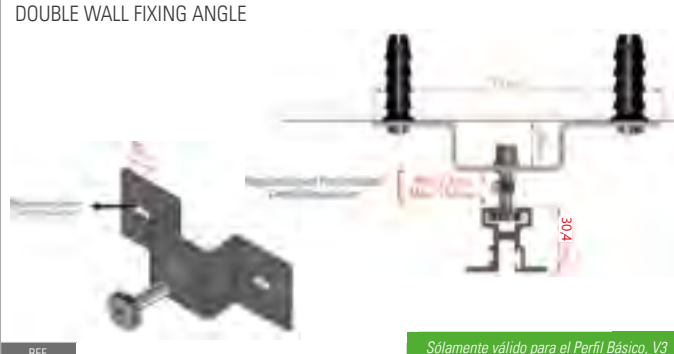

REF.
V107DB

Sólo válido para el Perfil Básico, V3
Only for the slotted, V3 Basic Profile

PIE REGULABLE

ADJUSTABLE FEET



REF.
V108

Sólo válido para el Perfil Básico, V3
Only for the slotted, V3 Basic Profile

CEPILLO 7x10 1P

7x10 BRUSH



Bolsa / Plastic Bag : **2,8 m.**

REF.	ACABADO / FINISHING
16010C.K.G	Gris / Grey
16010C.K.B	Blanco / White

CLIP PANELADO

PANEL FIXING PLASTIC PLATE



REF.
V109

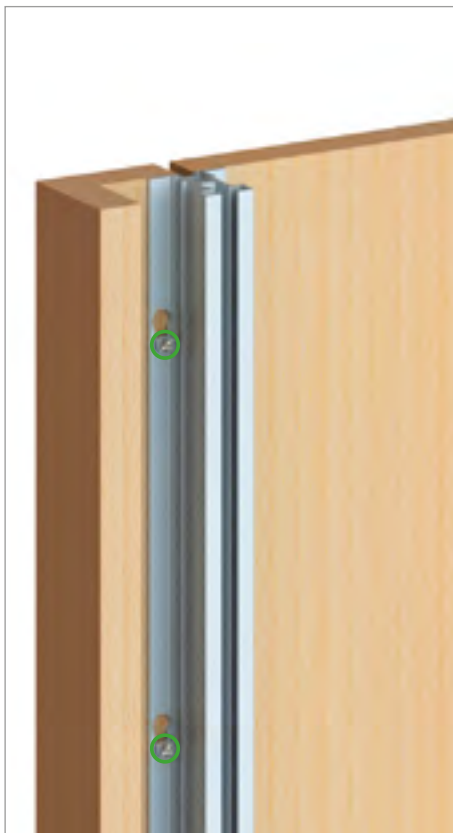
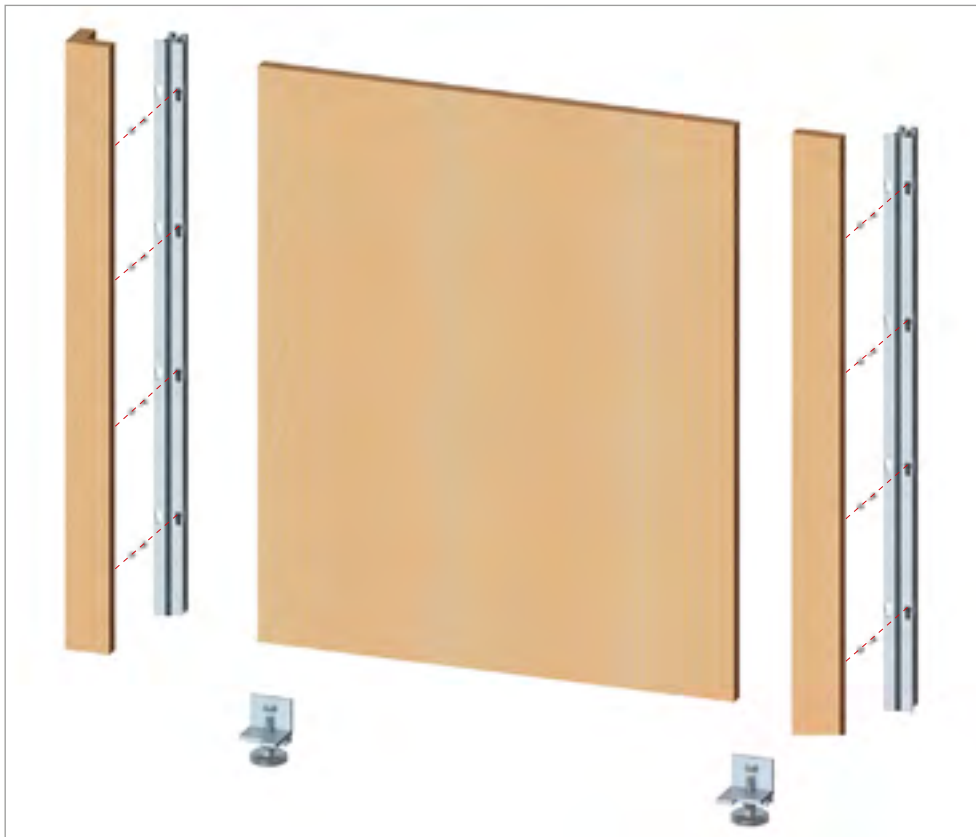

PERFIL BASICO V3 CON MECANIZADO BOCALLAVE + ANCLAJES CON TIRAFONDO

SLOTTED BASIC PROFILE

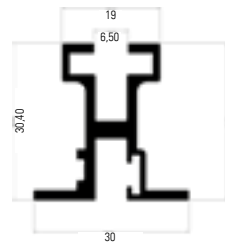

2600mm

2300mm

1500mm

900mm

200mm

REF.
V103.A.N

Longitud / Length : 2,8 m

COMPLEMENTOS

COMPLEMENTS

PIE REGULABLE LADO IZQUIERDO

LEFT SWIVELING FOOT



REF.
V108.FIZ

Sólo válido para el Perfil Básico, V3
Only for the slotted, V3 Basic Profile

PIE REGULABLE DERECHO

RIGHT SWIVELING FOOT



REF.
V108.FDCH

Sólo válido para el Perfil Básico, V3
Only for the slotted, V3 Basic Profile

CARTELAS PARA ATORNILLAR

BRACKETS FOR SCREWS

CARTELA BALDA BAJA 30x543mm. PARA TORNILLOS DER. + IZQ.

RIGHT AND LEFT 30x543mm. LOWER SHELF BRACKET FOR SCREWS

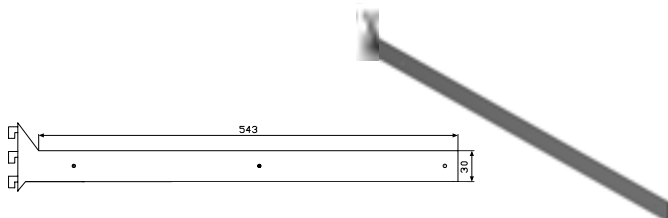

REF.	ACABADO / FINISHING
VT30/117	Gris / Grey
VT30/117.MK	Moka

CARTELA BALDA INTERMEDIA 30x543mm. PARA TORNILLOS DER.+ IZQ.

RIGHT AND LEFT 30x543mm. MIDDLE SHELF BRACKET FOR SCREWS

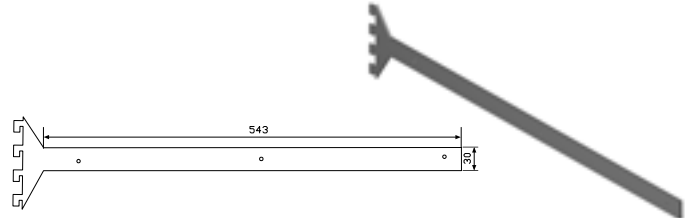

REF.	ACABADO / FINISHING
VT30/123	Gris / Grey
VT30/123.MK	Moka

CARTELA BALDA CAJONERA 30x543mm. PARA TORNILLOS DER. + IZQ.

RIGHT AND LEFT 30x543mm. DRAWER SHELF BRACKET FOR SCREWS

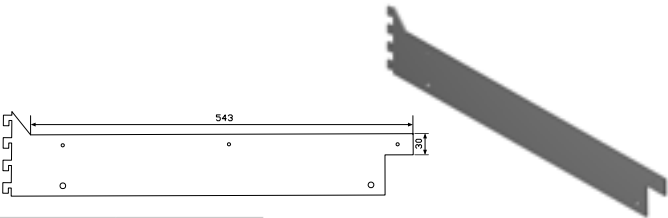

REF.	ACABADO / FINISHING
VT30/137	Gris / Grey
VT30/137.MK	Moka

CARTELA BALDA INTERMEDIA 30x350mm. PARA TORNILLOS DER.+ IZQ.

RIGHT AND LEFT 30x350mm. MIDDLE SHELF BRACKET FOR SCREWS

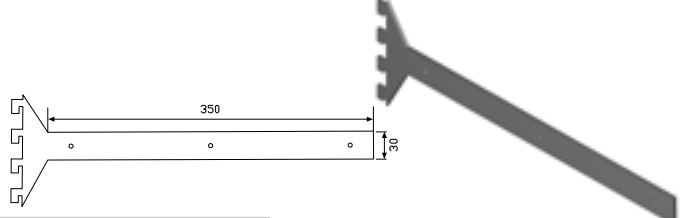

REF.	ACABADO / FINISHING
VT30/122	Gris / Grey
VT30/122.MK	Moka

CARTELA ZAPATERO DER. + IZQ.

RIGHT AND LEFT SHOE RACK BRACKET SET

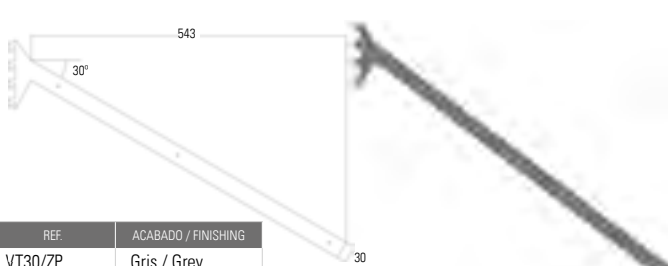

REF.	ACABADO / FINISHING
VT30/ZP	Gris / Grey
VT30/ZP.MK	Moka

CARTELA CAJONERA OCULTA DER. + IZQ.

RIGHT AND LEFT CONCEALED DRAWER BRACKET SET

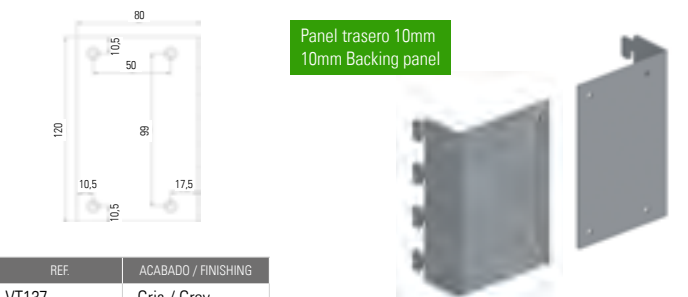

REF.	ACABADO / FINISHING
VT137	Gris / Grey

CARTELAS PARA BALDAS CON MECANIZADO (CLOC)

BRACKETS FOR CLOC MECHANIZED SHELVES

CARTELA BALDA BAJA 40x543mm.

40x543mm. LOWER SHELF BRACKET

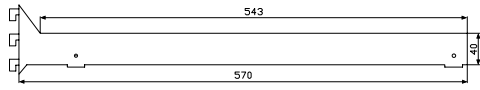

REF.

V111 (derecha / right)
V112 (izquierda / left)
V113 (central / center)

CARTELA BALDA INTERMEDIA 40x543mm.

40x543mm. MIDDLE SHELF BRACKET

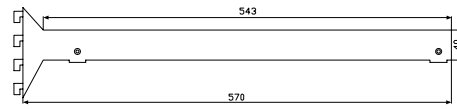

REF.

V121 (derecha / right)
V122 (izquierda / left)
V123 (central / center)

CARTELA BALDA CAJONERA 40x543mm.

40x543mm. DRAWER SHELF BRACKET

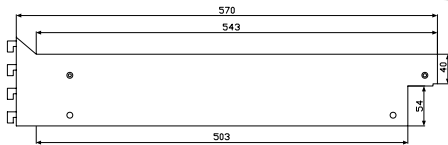

REF.

V131 (derecha / right)
V132 (izquierda / left)
V133 (central / center)

CARTELA BALDA BAJA 30x543mm.

30x543mm. LOWER SHELF BRACKET

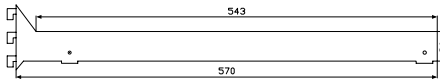

REF.

V30/114 (derecha / right)
V30/115 (izquierda / left)
V30/116 (central / center)

CARTELA BALDA INTERMEDIA 30x543mm.

30 x 543mm. MIDDLE SHELF BRACKET

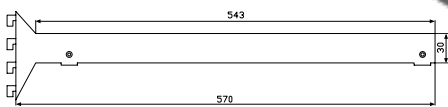

REF.

V30/124 (derecha / right)
V30/125 (izquierda / left)
V30/126 (central / center)

CARTELA BALDA CAJONERA 30x543mm.

30x543mm. DRAWER SHELF BRACKET

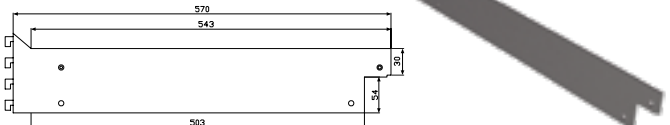

REF.

V30/134 (derecha / right)
V30/135 (izquierda / left)
V30/136 (central / center)

CARTELA BALDA INTERMEDIA 40x350mm.

40x350mm. MIDDLE SHELF BRACKET

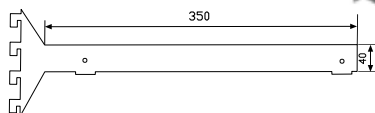

REF.

V127 (derecha / right)
V128 (izquierda / left)
V129 (central / center)

CARTELA BALDA INTERMEDIA 30x350mm.

30x350mm. MIDDLE SHELF BRACKET

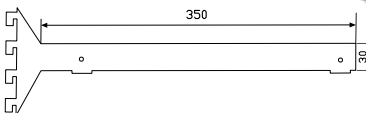

REF.

V30/127 (derecha / right)
V30/128 (izquierda / left)
V30/129 (central / center)

HERRAJE CARTELA BALDA SIMPLE

SINGLE SHELF MOUNTING ACCESSORIES



REF.

V140

x2

x2

x2

x2

HERRAJE CARTELA BALDA DOBLE

DOUBLE SHELF MOUNTING ACCESSORIES



REF.

V150

x4

x2

x4

x2

HERRAJE CARTELA CAJONERA SIMPLE

SINGLE DRAWER MOUNTING ACCESSORIES



REF.

V160

x2

x2

x2

x2

x2

x2

HERRAJE CARTELA CAJONERA DOBLE

DOUBLE DRAWER MOUNTING ACCESSORIES



REF.

V170

x4

x2

x4

x2

x2

x4

CARTELAS PARA VIDRIO

BRACKETS FOR GLASS

CARTELA VIDRIO IZQUIERDA + DERECHA

RIGHT AND LEFT GLASS SHELF BRACKET SET

Panel trasero 10mm
10mm Backing panel

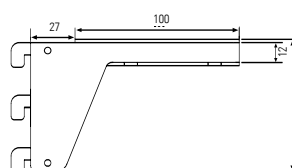
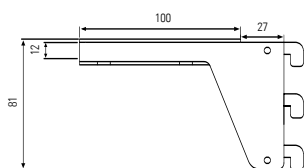

Para vidrio de 4 a 10mm.
For glass up to 10mm.

REF.	ACABADO / FINISHING
V110C.IZ.DCH	Gris / Grey

CARTELA VIDRIO IZQUIERDA + DERECHA

RIGHT AND LEFT GLASS SHELF BRACKET SET

Panel trasero 10mm
10mm Backing panel

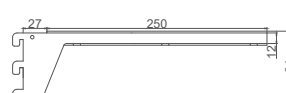
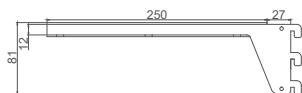

Para vidrio de 4 a 10mm.
For glass up to 10mm.

REF.	ACABADO / FINISHING
V110C.IZ.DCH.25	Gris / Grey

PLANTILLA MONTAJE COLOMA

COLOMA ASSEMBLY TEMPLATE

PLANTILLA MONTAJE COLOMA

COLOMA ASSEMBLY TEMPLATE



x2

REF.

V180

DESCÁRGATE LAS INSTRUCCIONES COMPLETAS EN:
www.adinor.info/instrucciones-de-montaje
(VIDEO PLANTILLA COLOMA)

DOWNLOAD THE COMPLETE ASSEMBLY INSTRUCTIONS
www.adinor.info/instrucciones-de-montaje
(COLOMA VIDEO TEMPLATE)

CARTELAS PARA ATORNILLAR (modelo USA)

BRACKETS FOR SCREWS (USA model)

CARTELA BALDA BAJA 38,1 mm (1 1/2") x 305 mm (12")

38,1mm (1 1/2") x 305mm (12") LOWER SHELF BRACKET



ACABADOS	FINISHES	REF.
Gris	Grey	HVT11/2.B.12.G
Moka	Moka	HVT11/2.B.12.M

CARTELA BALDA BAJA 38,1 mm (1 1/2") x 356 mm (14")

38,1mm (1 1/2") x 356mm (14"). LOWER SHELF BRACKET

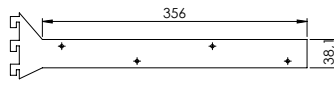

ACABADOS	FINISHES	REF.
Gris	Grey	HVT11/2.B.14.G
Moka	Moka	HVT11/2.B.14.M

CARTELA BALDA BAJA 38,1 mm (1 1/2") x 457 mm (18")

38,1mm (1 1/2") x 457mm (18") LOWER SHELF BRACKET

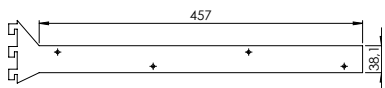

ACABADOS	FINISHES	REF.
Gris	Grey	HVT11/2.B.18.G
Moka	Moka	HVT11/2.B.18.M

CARTELA BALDA BAJA 38,1 mm (1 1/2") x 559 mm (22")

38,1 mm (1 1/2") x 559 mm (22"). LOWER SHELF BRACKET

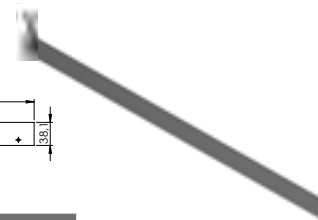
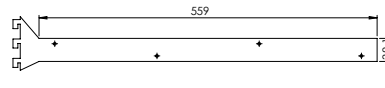

ACABADOS	FINISHES	REF.
Gris	Grey	HVT11/2.B.22.G
Moka	Moka	HVT11/2.B.22.M

CARTELA BALDA BAJA 28,5 mm (1 1/8") x 305 mm (12")

28,5 mm (1 1/8") x 305 mm (12"). LOWER SHELF BRACKET

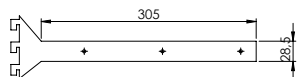

ACABADOS	FINISHES	REF.
Gris	Grey	HVT11/8.B.12.G
Moka	Moka	HVT11/8.B.12.M

CARTELA BALDA BAJA 28,5 mm (1 1/8") x 356 mm (14")

28,5 mm (1 1/8") x 356 mm (14") LOWER SHELF BRACKET

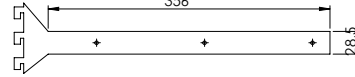

ACABADOS	FINISHES	REF.
Gris	Grey	HVT11/8.B.14.G
Moka	Moka	HVT11/8.B.14.M

CARTELA BALDA BAJA 28,5 mm (1 1/8") x 457 mm (18")

28,5 mm (1 1/8") x 457 mm (18") LOWER SHELF BRACKET

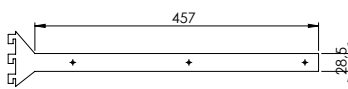

ACABADOS	FINISHES	REF.
Gris	Grey	HVT11/8.B.18.G
Moka	Moka	HVT11/8.B.18.M

CARTELA BALDA BAJA 28,5 mm (1 1/8") x 559 mm (22")

28,5 mm (1 1/8") x 559 mm (22") LOWER SHELF BRACKET

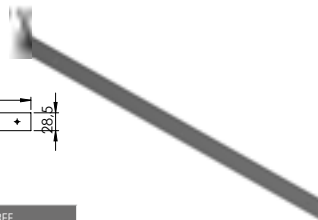
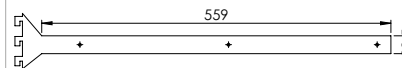

ACABADOS	FINISHES	REF.
Gris	Grey	HVT11/8.B.22.G
Moka	Moka	HVT11/8.B.22.M

CARTELA BALDA INTERMEDIA 38,1 mm (1 1/2") x 305 mm (12")

38,1 mm (1 1/2") x 305 mm (12") MIDDLE SHELF BRACKET

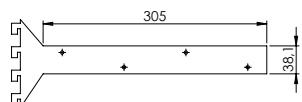

ACABADOS	FINISHES	REF.
Gris	Grey	HVT11/2.I.12.G
Moka	Moka	HVT11/2.I.12.M

CARTELA BALDA INTERMEDIA 38,1 mm (1 1/2") x 356 mm (14")

38,1 mm (1 1/2") x 356 mm (14") MIDDLE SHELF BRACKET

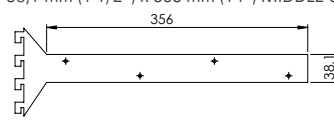

ACABADOS	FINISHES	REF.
Gris	Grey	HVT11/2.I.14.G
Moka	Moka	HVT11/2.I.14.M

CARTELA BALDA INTERMEDIA 38,1 mm (1 1/2") x 457 mm (18")

38,1 mm (1 1/2") x 457 mm (18") MIDDLE SHELF BRACKET

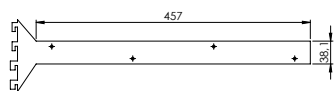

ACABADOS	FINISHES	REF.
Gris	Grey	HVT11/2.I.18.G
Moka	Moka	HVT11/2.I.18.M

CARTELA BALDA INTERMEDIA 38,1 mm (1 1/2") x 559 mm (22")

38,1 mm (1 1/2") x 559 mm (22") MIDDLE SHELF BRACKET

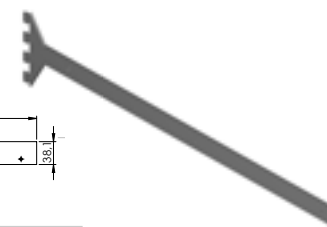
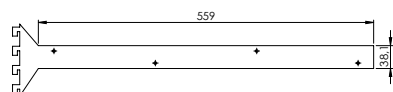

ACABADOS	FINISHES	REF.
Gris	Grey	HVT11/2.I.22.G
Moka	Moka	HVT11/2.I.22.M

CARTELA BALDA INTERMEDIA 28,5 mm (1 1/8") x 305 mm (12")

28,5 mm (1 1/8") x 305 mm (12") MIDDLE SHELF BRACKET

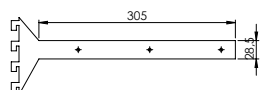

ACABADOS	FINISHES	REF.
Gris	Grey	HVT11/8.I.12.G
Moka	Moka	HVT11/8.I.12.M

CARTELA BALDA INTERMEDIA 28,5 mm (1 1/8") x 356 mm (14")

28,5 mm (1 1/8") x 356 mm (14") MIDDLE SHELF BRACKET

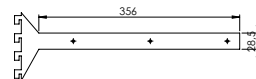

ACABADOS	FINISHES	REF.
Gris	Grey	HVT11/8.I.14.G
Moka	Moka	HVT11/8.I.14.M

CARTELA BALDA INTERMEDIA 28,5 mm (1 1/8") x 457 mm (18")

28,5 mm (1 1/8") x 457 mm (18"). MIDDLE SHELF BRACKET

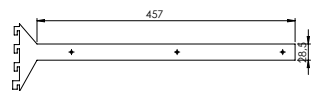

ACABADOS	FINISHES	REF.
Gris	Grey	HVT11/8.I.18.G
Moka	Moka	HVT11/8.I.18.M

CARTELA BALDA INTERMEDIA 28,5 mm (1 1/8") x 559 mm (22")

28,5 mm (1 1/8") x 559 mm (22"). MIDDLE SHELF BRACKET

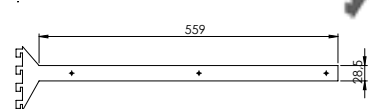

ACABADOS	FINISHES	REF.
Gris	Grey	HVT11/8.I.22.G
Moka	Moka	HVT11/8.I.22.M

CARTELA BALDA CAJONERA 38,1 mm (1 1/2") x 305 mm (12")

38,1 mm (1 1/2") x 305 mm (12"). DRAWER SHELF BRACKET

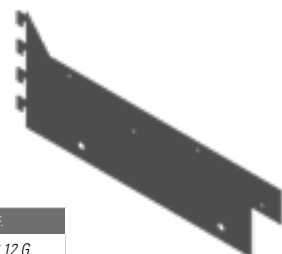
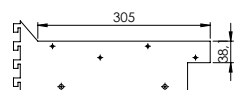

ACABADOS	FINISHES	REF.
Gris	Grey	HVT11/2.C.12.G
Moka	Moka	HVT11/2.C.12.M

CARTELA BALDA CAJONERA 38,1 mm (1 1/2") x 356 mm (14")

38,1 mm (1 1/2") x 356 mm (14"). DRAWER SHELF BRACKET

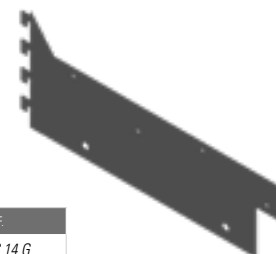
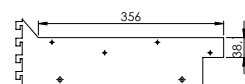

ACABADOS	FINISHES	REF.
Gris	Grey	HVT11/2.C.14.G
Moka	Moka	HVT11/2.C.14.M

CARTELA BALDA CAJONERA 38,1 mm (1 1/2") x 457 mm (18")

38,1 mm (1 1/2") x 457 mm (18"). DRAWER SHELF BRACKET

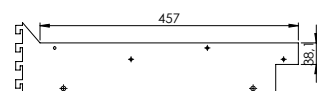

ACABADOS	FINISHES	REF.
Gris	Grey	HVT11/2.C.18.G
Moka	Moka	HVT11/2.C.18.M

CARTELA BALDA CAJONERA 38,1 mm (1 1/2") x 559 mm (22")

38,1 mm (1 1/2") x 559 mm (22"). DRAWER SHELF BRACKET

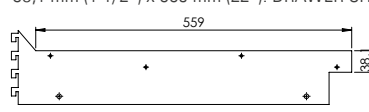

ACABADOS	FINISHES	REF.
Gris	Grey	HVT11/2.C.22.G
Moka	Moka	HVT11/2.C.22.M

CARTELA BALDA CAJONERA 28,5 mm (1 1/8") x 305 mm (12")

28,5 mm (1 1/8") x 305 mm (12") DRAWER SHELF BRACKET

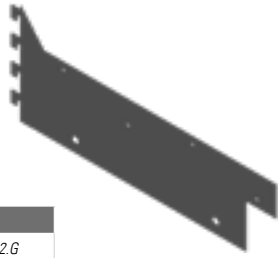
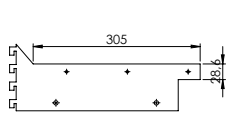

ACABADOS	FINISHES	REF.
Gris	Grey	HVT11/8.C.12.G
Moka	Moka	HVT11/8.C.12.M

CARTELA BALDA CAJONERA 28,5 mm (1 1/8") x 356 mm (14")

28,5 mm (1 1/8") x 356 mm (14") DRAWER SHELF BRACKET

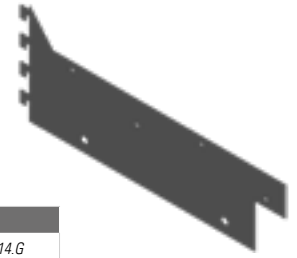

ACABADOS	FINISHES	REF.
Gris	Grey	HVT11/8.C.14.G
Moka	Moka	HVT11/8.C.14.M

CARTELA BALDA CAJONERA 28,5 mm (1 1/8") x 457 mm (18")

28,5 mm (1 1/8") x 457 mm (18") DRAWER SHELF BRACKET

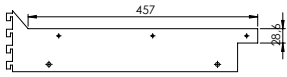

ACABADOS	FINISHES	REF.
Gris	Grey	HVT11/8.C.18.G
Moka	Moka	HVT11/8.C.18.M

CARTELA BALDA CAJONERA 28,5 mm (1 1/8") x 559 mm (22")

28,5 mm (1 1/8") x 559 mm (22") DRAWER SHELF BRACKET

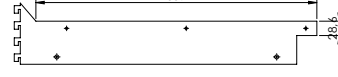

ACABADOS	FINISHES	REF.
Gris	Grey	HVT11/8.C.22.G
Moka	Moka	HVT11/8.C.22.M

CARTELA VIDRIO IZQUIERDA + DERECHA

RIGHT AND LEFT GLASS SHELF BRACKET SET

Panel trasero 19mm
19mm Backing panel

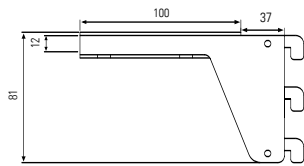

REF.	ACABADO/FINISHING
HVT110KIT.CV.G	Gris / Grey

CARTELA CAJONERA OCULTA DER. + IZO.

RIGHT AND LEFT CONCEALED DRAWER BRACKET SET

Panel trasero 19mm
19mm Backing panel

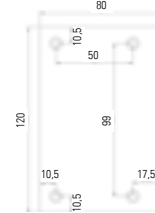

REF.	ACABADO / FINISHING
HVT.CO.G	Gris / Grey
HVT.CO.M	Moka/Moka

CARTELA BALDA INCLINADA 38,1 mm (1 1/2") x 356 mm (14")

38,1 mm (1 1/2") x 356 mm (14") 30° SHELF BRACKET

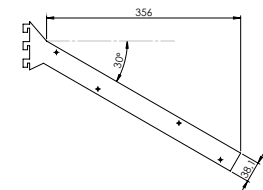

ACABADOS	FINISHES	REF.
Gris	Grey	HVT11/2.Z.14.G
Moka	Moka	HVT11/2.Z.14.M

CARTELA BALDA INCLINADA 38,1 mm (1 1/2") x 457 mm (18")

38,1 mm (1 1/2") x 457 mm (18") 30° SHELF BRACKET

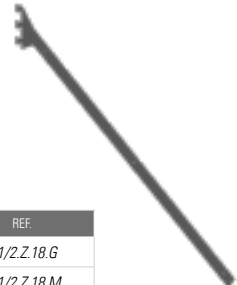
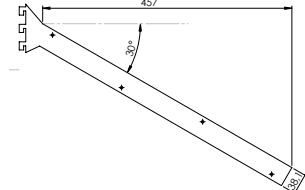

ACABADOS	FINISHES	REF.
Gris	Grey	HVT11/2.Z.18.G
Moka	Moka	HVT11/2.Z.18.M

CARTELA BALDA INCLINADA 28,5 mm (1 1/8") x 356 mm (14")

28,5 mm (1 1/8") x 356 mm (14") 30° SHELF BRACKET

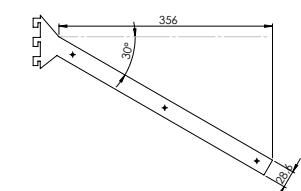

ACABADOS	FINISHES	REF.
Gris	Grey	HVT11/8.Z.14.G
Moka	Moka	HVT11/8.Z.14.M

CARTELA BALDA INCLINADA 28,5 mm (1 1/8") x 457 mm (18")

28,5 mm (1 1/8") x 457 mm (18") 30° SHELF BRACKET

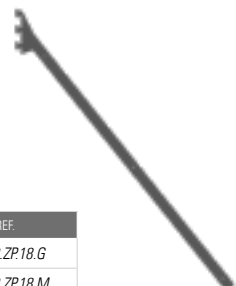
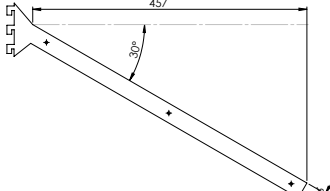

ACABADOS	FINISHES	REF.
Gris	Grey	HVT11/8.ZP.18.G
Moka	Moka	HVT11/8.ZP.18.M

COLOMA

INSTRUCCIONES DE MONTAJE

ASSEMBLY INSTRUCTIONS

ADINOR

ESCANÉALO!
SCAN IT!



VIDEO INSTRUCCIONES DE MONTAJE
ASSEMBLY INSTRUCTIONS VIDEO

DESCÁRGATE LAS INSTRUCCIONES COMPLETAS EN:
www.adinor.info/instrucciones-de-montaje
(VIDEO SISTEMA COLOMA)
DOWNLOAD THE COMPLETE INSTRUCTIONS

MONTAJE SISTEMA SIN MECANIZADO

NONE MECHANIZED SYSTEM ASSEMBLY

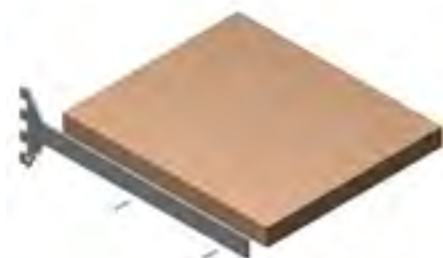
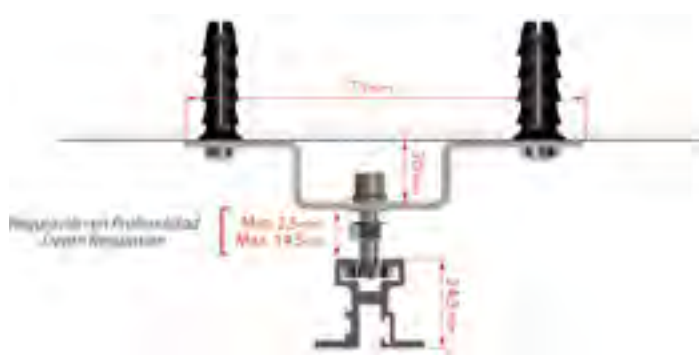

MONTAJE SISTEMA MECANIZADO

MECHANIZED SYSTEM ASSEMBLY

MECANIZADO PANEL TRASERO

BACKING PANEL ASSEMBLY



*Según grosor panel
Depends on the panel
thickness



MECANIZADO BALDAS

SHELF ASSEMBLY

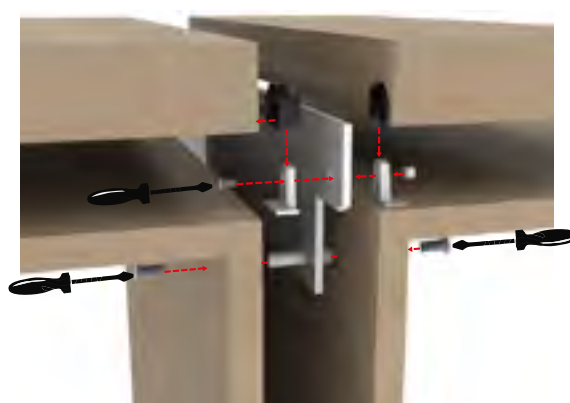
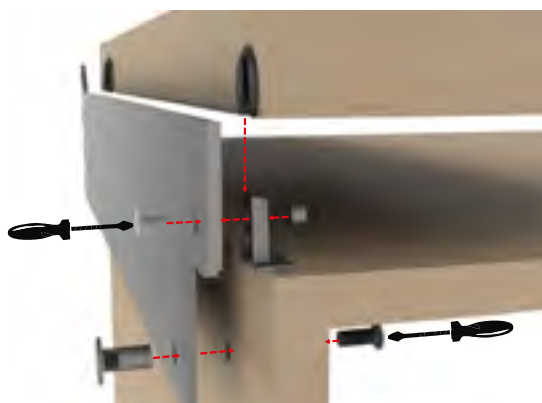
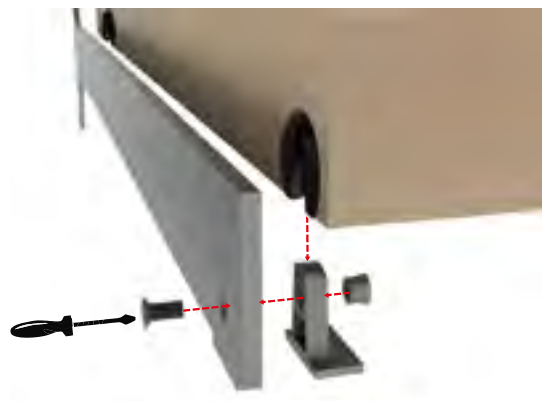
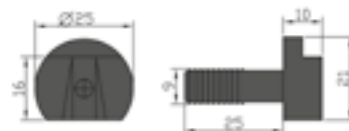
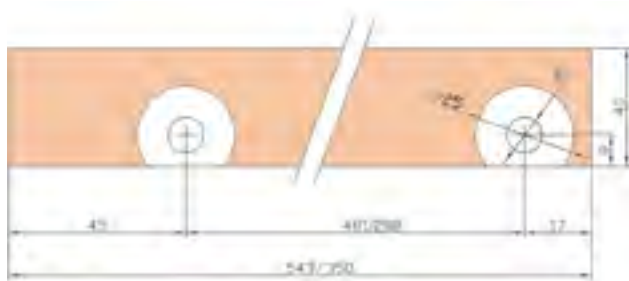

SISTEMA UNIX

UNIX SYSTEM









CONCEPTO FUNCIONAL

De gran versatilidad, permite dos tipos de construcciones:
Suelo-Techo ó *Suelo-Pared*

A diferencia de los diseños tradicionales de módulos con costados de madera, este sistema permite una visión global de todos los artículos que se expongan.

La perfilera vertical de aluminio tiene el canal longitudinal en la cara trasera, las tuercas quedan ocultas a la vista y los soportes de la balda poco visibles. Las baldas pueden ser reguladas a la altura deseada.

Las cartelas permiten utilizar baldas para madera o vidrio, pudiendo inclinarse hasta 38°.

Este sistema nos permite recubrir el perfil con los mismos acabados que las baldas creando una integración total entre ambos.

SUMMARY

This system has a great versatility. It permits two types of assembly:

From floor to ceiling or *From floor to wall*

There is a difference with traditional designs, which are manufactured with wooden sides, Unix allows a quick overall view of all the exposed articles.

The vertical aluminium profile has a longitudinal slot on the rear face, the nuts are hidden from view and the shelf supports are barely visible. The shelves can be fixed at any height.

The shelf's brackets allow the use of wooden or glassy material and are able to lean 38°.

This system allows wrapping the profile with the same finishings as the shelves making a complete integration on both elements.



UNIX

ADINOR

UNIX

VERTICAL UNIX
UNIX VERTICAL PROFILE



ACABADOS	FINISHINGS	Longitud / Length : 2,7 m.
LACADOS	COATED	REF.
Blanco Mate Ral 9010	Mat White	5488.L.BM
Negro Mate Ral 9011	Mat Black	5488.L.NM
Antracita	Anthracite	5488.L.ANT
ANODIZADOS	ANODIZED	REF.
Plata Mate	Natural Anodized	5488.A.PM
MELAMINA	MELAMINE	REF.
Roble RO 444	Oak	5488.M.RBRO
Textil Coral	Textil	5488.M.TXCO
Sapely D2517	Sapely	5488.M.SPD
Haya Vapor. 428	Steam Beech	5488.M.YV
Blanco Rebornizable	White	5488.M.MR
MADERA	NATURAL WOOD	REF.
Roble Francés	Oak	5488.C.RB
Sapely	Sapely	5488.C.SP
Cerezo	Cherry Tree	5488.C.CZ
Pino	Pine	5488.C.PN
Haya Blanca	Beech Tree	5488.C.Y
VINILO	VINYL	REF.
Blanco RAL 9003	Blanco RAL 9003	5488.V.9003



COMPONENTES COMPONENTS

SUPLEMENTO PIE

FIXING NAIL FOR ADJUSTABLE FEET



REF.

5565

PIE REGULABLE + UNIÓN PERFIL UNIX

ADJUSTABLE FEET



REF.

5477.L.CM (cromo mate)

CONECTOR ANGULO RECTO UNIX

UNIX CONNECTION ANGLE

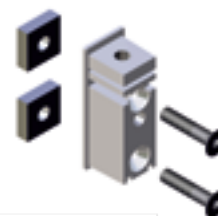

REF.

5466.L.CM (cromo mate)

SOPORTE FIJACIÓN PARED SISTEMA UNIX

UNIX WALL FIXING PLATE



REF.

5455.L.CM (cromo mate)

NO INCLUYE / NO INCLUDED

Tornillo / Screw

SOPORTE BALDA PARA MADERA UNIX

SHELF SUPPORT

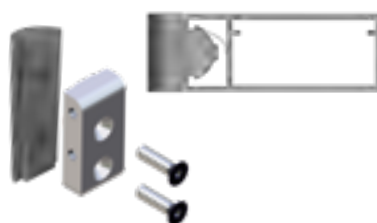

REF.

5444.L.CM (cromo mate)

CARTELA PARA VIDRIO

GLASS PANEL BRACKET

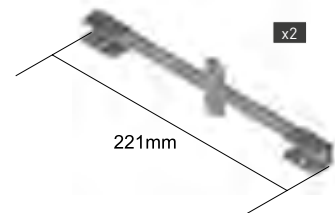

REF.

5434.2.L.PM

INCLUYE / INCLUDED

+2 Tornillos / Screws

CARTELA ALUMINIO PARA MADERA INCL38°

ALUMINIUM WOOD PANEL BRACKET 38°

Inclinable 38°
38° Tilttable

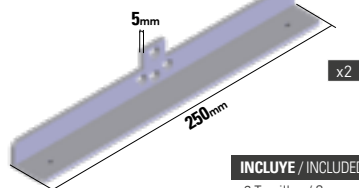

INCLUYE / INCLUDED

+2 Tornillos / Screws

ACABADOS	FINISHINGS	REF.
Blanco Mate	Mat White	5433.2.L.BM
Negro Mate	Mat Black	5433.2.L.NM
Plata Mate	Natural Anodized	5433.2.L.PM

CONJUNTO SOPORTE LATERAL RECTANGULAR

RECTANGULAR LATERAL SUPORT

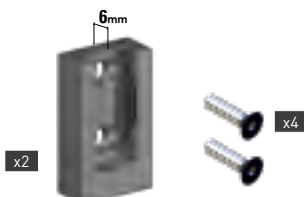

ACABADOS	FINISHINGS	REF.
Blanco Mate	Mat White	51954BM
Negro Mate	Mat Black	51954NM
Plata Mate	Natural Anodized	51954PM
Moka	Moka	51954MK
Antracita	Anthracite	51954ANT

INSTRUCCIONES DE MONTAJE ASSEMBLY INSTRUCTIONS

DESCÁRGATE LAS INSTRUCCIONES COMPLETAS EN:
www.adinor.info/instrucciones-de-montaje
(Instrucciones montaje SISTEMA UNIX)

DOWNLOAD THE COMPLETE ASSEMBLY INSTRUCTIONS
www.adinor.info/instrucciones-de-montaje

UNIX

KITS SETS

ADINOR

KIT SUELO-TECHO

FLOOR-CEILING SET

KIT SUELO-PARED

FLOOR-WALL SET



ACABADOS	FINISHINGS	REF.	REF.
LACADOS	COATED	REF.	REF.
Blanco Mate Ral 9010	Mat White	5910.L.BM	5920.L.BM
Negro Mate Ral 9011	Mat Black	5910.L.NM	5920.L.NM
Antracita	Anthracite	5910.L.ANT	5920.L.ANT
ANODIZADOS	ANODIZED	REF.	REF.
Plata Mate	Natural Anodized	5910.A.PM	5920.A.PM
MELAMINA	MELAMINE	REF.	REF.
Roble RO 444	Oak	5910.M.RBRO	5920.M.RBRO
Textil Coral	Textil	5910.M.TXCO	5920.M.TXCO
Sapely D2517	Sapely	5910.M.SPD	5920.M.SPD
Haya Vapor. 428	Steam Beech	5910.M.YV	5920.M.YV
Blanco Rebornizable	White	5910.M.MR	5920.M.MR
MADERA	NATURAL WOOD	REF.	REF.
Roble Francés	Oak	5910.C.RB	5920.C.RB
Sapely	Sapely	5910.C.SP	5920.C.SP
Cerezo	Cherry Tree	5910.C.CZ	5920.C.CZ
Pino	Pine	5910.C.PN	5920.C.PN
Haya Blanca	Beech Tree	5910.C.Y	5920.C.Y
VINILO	VINYL	REF.	REF.
Blanco RAL 9003	Blanco RAL 9003	5910.V.9003	5920.V.9003

SISTEMA DOMINÓ

DOMINÓ SYSTEM









CONCEPTO FUNCIONAL

De gran versatilidad, permite dos tipos de construcciones:
Suelo-Techo ó Suelo-Pared

A diferencia de los diseños tradicionales de módulos con costados de madera, este sistema permite una visión global de todos los artículos que se expongan.

Gracias a la perfilera de aluminio con canal lateral y a las tuercas cabeza martillo, las baldas pueden ser reguladas a la altura deseada.

Las cartelas permiten utilizar baldas para madera o vidrio, pudiendo inclinarse hasta 38°.

SUMMARY

This system has a great versatility. It permits two types of assembly:

From floor to ceiling or From floor to wall

There is a difference with traditional designs, which are manufactured with wooden sides, Domino allows a quick overall view of all the exposed articles.

Thanks to the aluminium profiles having a lateral slot and the use of hammer head nuts the shelves can be fixed at any height. The shelf's brackets allow the use of wooden or glassy material and are able to lean 38°.

DOMINÓ

ADINOR

PERFIL 1 SALIDA

PROFILE 1 SLOT



REF.
5027.A.PM

Longitud / Length : 3 m.

PERFIL 2 SALIDAS 90°

PROFILE 2 SLOTS



REF.
5028.A.PM

Longitud / Length : 3 m.

PERFIL 3 SALIDAS

PROFILE 3 SLOTS



REF.
5029.A.PM

Longitud / Length : 3 m.

PERFIL 2 SALIDAS

PROFILE 2 SLOTS

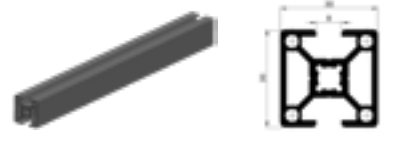

REF.
5025.A.PM

Longitud / Length : 3 m.

PERFIL 4 SALIDAS

PROFILE 4 SLOTS



REF.
5010.A.PM

Longitud / Length : 3 m.

PERFIL MEDIA CAÑA

MC-30 PROFILE



REF.
5017.A.PM

Longitud / Length : 3 m.

TAPACANAL

GROOVE COVER PROFILE



REF.
5101301

Longitud / Length : 3 m.

PIE DE ACERO DIÁMETRO 35mm.

ADJUSTABLE FEET Ø 35mm.



REF.
5564

SUPLEMENTO PIE

FIXING NAIL FOR ADJUSTABLE FEET



REF.
5565

SOPORTE FIJACIÓN PARED

WALL FIXING PLATE



REF.
5566

INCLUYE / INCLUDES
Tornillo/Screw

ESCUADRA INTERIOR - EXTERIOR

CONNECTION ANGLE



REF.
537830

TAPETA CUADRANGULAR

END COVERS



REF.
5508 (negro / black)
55081 (gris / grey)

TAPETA MEDIA CAÑA

END COVERS



REF.
55010 (negro / black)
550101 (gris / grey)

CARTELA ALUMINIO PARA MADERA

ALUMINIUM WOOD PANEL BRACKET



x2

Inclinable 38°
38° Tilttable

INCLUYE / INCLUDES
+4 Tornillos / Screws
+ Tuercas / Nuts

REF:
5560.2.M

CARTELA ALUMINIO PARA VIDRIO

ALUMINIUM GLASS PANEL BRACKET



x2

Vidrio 0 - 10 mm.
Glass 0 - 10 mm.

INCLUYE / INCLUDES
+2 Tornillo / Screw
+2 Tuercas / Nut

REF:
5561.2.M

ESCUADRA 40x40x35x4

CONNECTION ANGLE 40x40x35x4



INCLUYE / INCLUDES
+1 Tornillo / Screw
+1 Tuercas / Nut

REF:
5563

SOPORTE LATERAL ALUMINIO

SIDE TUBE HANGER



M5

NO INCLUYE TORNILLO
SCREW IS NOT INCLUDED

REF:
1952

SOPORTE CENTRAL ALUMINIO

CENTRAL TUBE HANGER



M5

NO INCLUYE TORNILLO
SCREW IS NOT INCLUDED

REF:
1953

TUERCA CABEZA MARTILLO

HUMMER HEAD NUT



REF:
M4 52074
M5 52075
M6 52076

BARRA COLGADOR CON GOMA

HANGER TUBE WITH PLASTIC PROFILE



REF:
195.A.PM.4

CONJUNTO SOPORTE LATERAL

SIDE TUBE HANGER SET



REF:
5569

TUERCA ANTIDESLIZANTE CON BOLA

SPRING-BALL NUT



REF:
M4 5064
M5 5065
M6 5066

CONECTOR PARALELO canal 8mm

PARALLEL JOINT, 8mm slot



REF:
535130

CONECTOR PERPENDICULAR canal 8mm

PERPENDICULAR JOINT, 8mm slot



REF:
535030

CONECTOR CABEZA REDONDA canal 8mm

ROUND HEAD JOINT, 8mm slot



REF:
535230

DOMINÓ

INSTRUCCIONES DE MONTAJE

ASSEMBLY INSTRUCTIONS

ADINOR

MONTAJE SUELO-PARED FLOOR-WALL ASSEMBLY

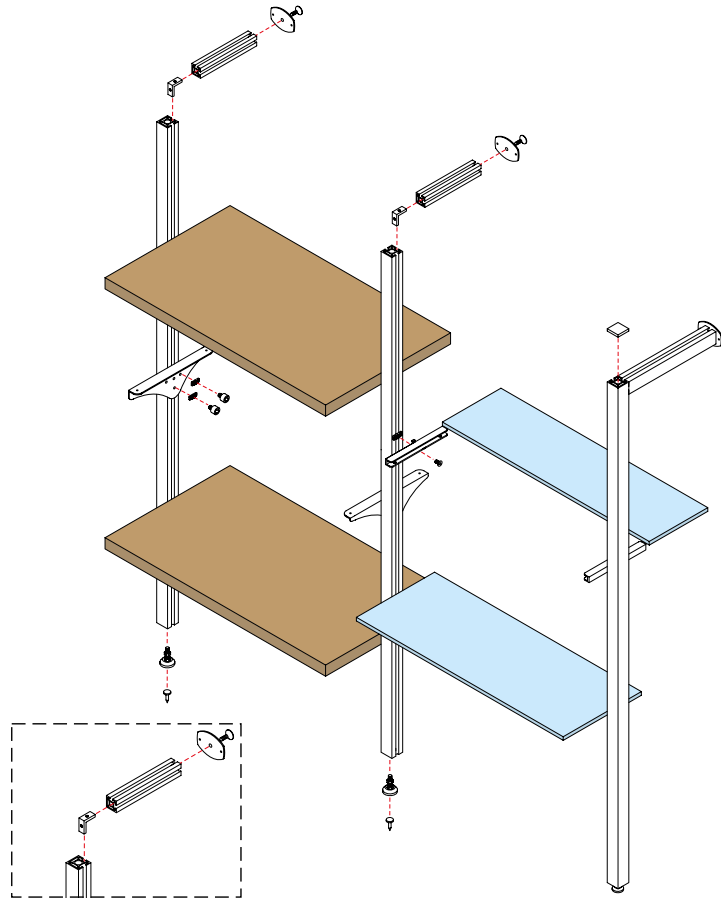

MONTAJE SUELO-TECHO FLOOR-CEILING ASSEMBLY

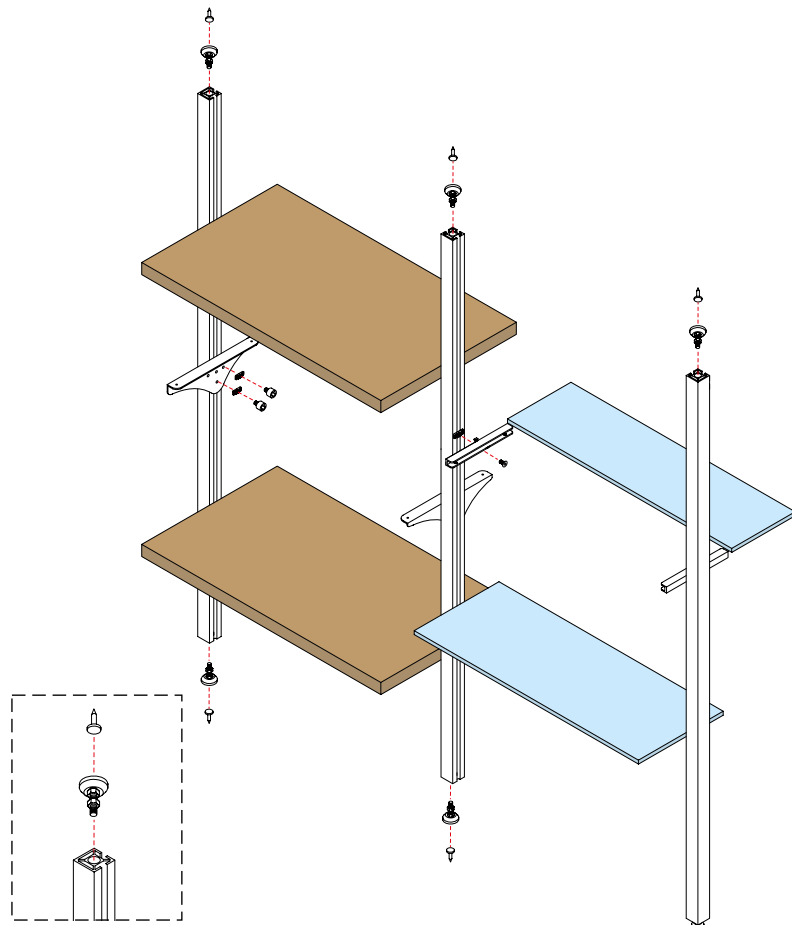

SISTEMA ABP

ABP SYSTEM



ABP

ABP SYSTEM

ADINOR

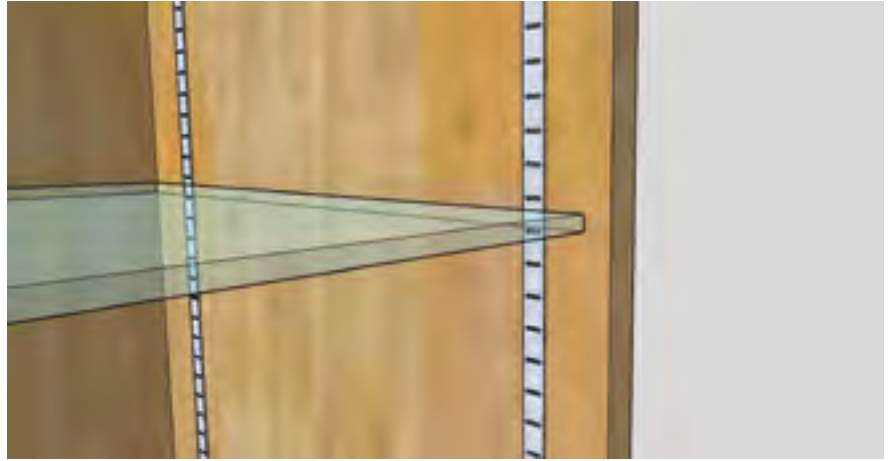

SISTEMA CREMALLERA EMPOTRABLE PARA ARMARIO

CUPBOARDS AND INSIDE CUPBOARDS ACCESSORIES

GUÍA PARA FORRAR ESTANTERÍAS DENTRO DE LOS ARMARIOS

WALL UPRIGHT TO BUILD CUPBOARDS SHELVES



Mecanizar con fresa de 12mm.
Use 10mm Ø drill.



Longitud / Length : 2,6 m.

REF	ACABADO / FINISHING
V100ABP	Plata Mate / Natural Anodized

CARTELITA PARA ACOPLAR A GUÍA DE SOBREPONER

SMALL BRACKET TO FIT PULLING WALL UPRIGHT



REF	ACABADO / FINISHING
V110ABP	Plata Mate / Natural Anodized

STRUKTURA









CONCEPTO FUNCIONAL

Diseño flexible y versátil, que permite fabricar muebles a medida mediante una perfecta y sencilla unión de perfiles. Pudiendo combinar:

- Tableros de 10-30 mm.
- Vidrios de 6-10 mm.

Mobiliario personalizado, adaptado en cada caso a las necesidades requeridas.

SUMMARY

Flexible and versatile design which allow to create custom furnitures because of the perfect and simple joint between the aluminium profiles.

This system permits to combine:

- 10-30 mm thickness board.
- 6-10 mm glass.

Customized furniture, adapted in each case to all needs.



SISTEMA STRUKTURA

20x20

ADINOR

SISTEMA STRUKTURA 20x20 STRUKTURA SYSTEM 20x20

Perfil 20x20

Profile 20x20

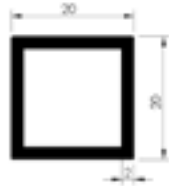

Perfil 20x20 Vidrio

Profile 20x20 for Glass

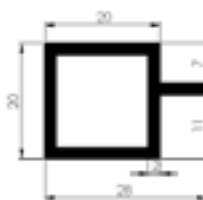

Perfil 20x20 madera

Profile 20x20 for wood

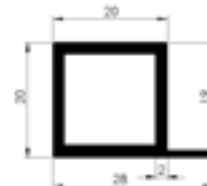

ACABADOS

FINISHINGS

LACADOS

COATED

Blanco Mate RAL 9003

Matt White RAL 9003

Negro Mate

Matt Black

Longitud / Length : 3,15 m

Longitud / Length : 3,15 m

Longitud / Length : 3,15 m

REF.

REF.

REF.

SKT2.L.BM03

SKT2.VL.BM03

SKT2.M.L.BM03

SKT2.L.NM

SKT2.V.L.NM

SKT2.M.L.NM

PERFIL REDUCTOR PARA VIDRIO 6-10 mm

GASKET FOR 6-10 MM GLASS



REF.

SKT2.PV.6-10

PIE NIVELADOR

ADJUSTABLE FEET



ACABADO / FINISHING

REF.

Metalico / metallic

SKT2.340

Plastico / Plastic

SKT2.330

ESCUADRA (Unión inglete)

INNER CONNECTION ANGLE



REF.

SKT2.125

PIEZA DE UNIÓN

JOINING ACCESSORY



REF.

SKT2.120

PLANTILLA

DRILL TEMPLATE



REF.

SKT2.410

TAPAS

END COVERS



ACABADO / FINISHING

REF.

Negro / Black

SKT2.530

Blanco / White

SKT2.540

Tipos de montaje

Assembly types

Normal Straight Cut



Inglete 45° Mitre cut

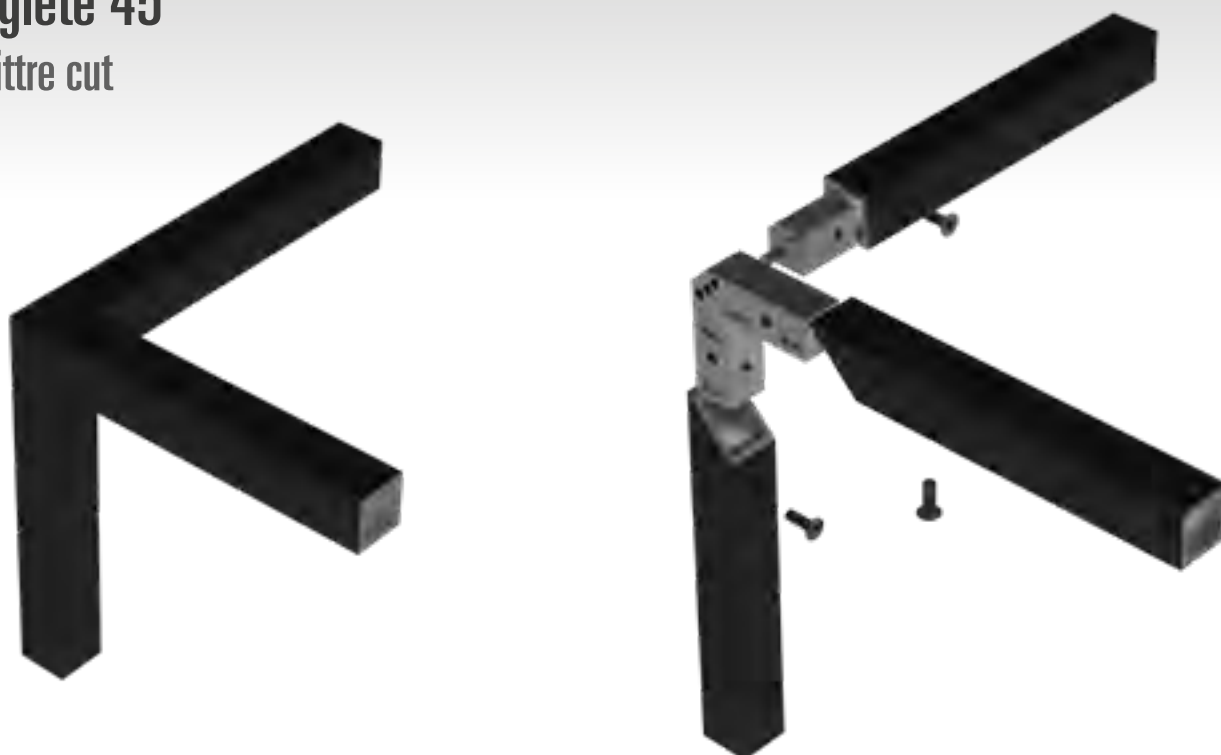

Mecanizado fijación pared

Keyhole machining

Para montaje encastrado a pared / For wall mounting

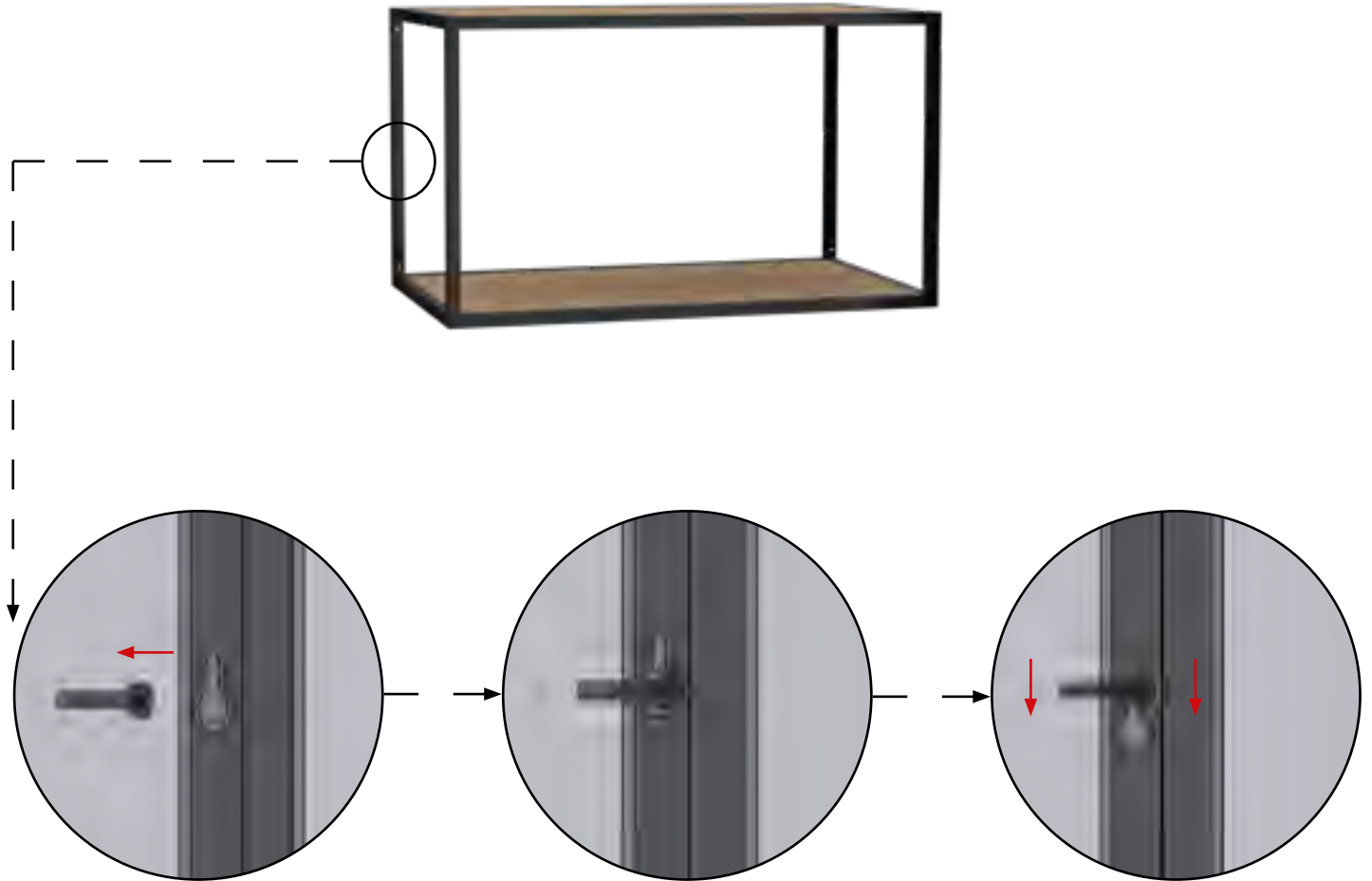

SISTEMA STRUKTURA

30x30

ADINOR

SISTEMA STRUKTURA 30x30 STRUKTURA SYSTEM 30x30

ADINOR
2021

Perfil 30x30

Profile 30x30

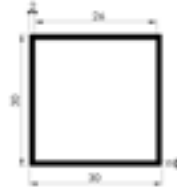

Longitud / Length : 3,15 m

ACABADOS

FINISHINGS

LACADOS

COATED

Blanco Mate RAL 9003

Matt White RAL 9003

Negro Mate

Matt Black

REF.

SKT.L.BM03

SKT.L.NM

PIEZA DE UNIÓN

JOINING ACCESSORY



REF.

SKT.100

CLOCK

CLOCK



REF.

SKT.200

PIE NIVELADOR

ADJUSTABLE FEET



ACABADO / FINISHING

REF.

Negro / Black

SKT.310

Blanco / White

SKT.320

BISAGRA MARCO ALUMINIO 105° REGULACIÓN 3D AMORTIGUADA

FACE FRAME 105° 3D REGULATION SOFT & SOFT
CLOSING HINGE



REF.

DESCRIPCIÓN

DESCRIPTION

HST11

RECTA

INSET

HST12

ACODADA

HALF-OVERLAY

TAPAS

END COVERS



ACABADO / FINISHING

REF.

Negro / Black

SKT.510

Blanco / White

SKT.520

PLANTILLA

DRILL TEMPLATE



REF.

SKT.400

Tipos de montaje

Assembly types

OPCIÓN BALDA BASTIDOR / BOARD FRAME OPTION

• Barras verticales de 2,7m + pie y suplemento

2.7 m Vertical profiles + adjustable feet

*MECANIZADOS DE BALDA INCLUIDOS / BOARD MACHINING INCLUDED



ACABADO	COATED	REF.	LARGO / LONG
Blanco Mate 9003	Matt White 9003	SKT.KITL.BM	2,7m
Negro Mate	Matt Black	SKT.KITL.NM	2,7m

Balda 4 lados / 4 side board

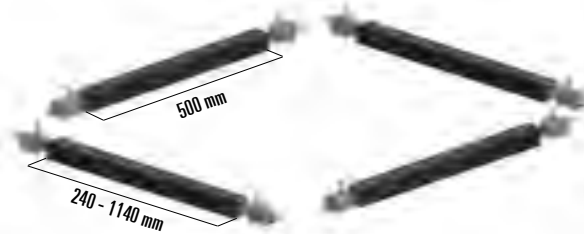

ACABADO	COATED	REF.	ANCHO	FONDO	ACABADO	COATED	REF.	ANCHO	FONDO
Blanco Mate 9003	Matt White 9003	SKT.BM.B4.30	300	560	Negro Mate	Matt Black	SKT.NM.B4.30	300	560
Blanco Mate 9003	Matt White 9003	SKT.BM.B4.40	400	560	Negro Mate	Matt Black	SKT.NM.B4.40	400	560
Blanco Mate 9003	Matt White 9003	SKT.BM.B4.50	500	560	Negro Mate	Matt Black	SKT.NM.B4.50	500	560
Blanco Mate 9003	Matt White 9003	SKT.BM.B4.60	600	560	Negro Mate	Matt Black	SKT.NM.B4.60	600	560
Blanco Mate 9003	Matt White 9003	SKT.BM.B4.70	700	560	Negro Mate	Matt Black	SKT.NM.B4.70	700	560
Blanco Mate 9003	Matt White 9003	SKT.BM.B4.80	800	560	Negro Mate	Matt Black	SKT.NM.B4.80	800	560
Blanco Mate 9003	Matt White 9003	SKT.BM.B4.90	900	560	Negro Mate	Matt Black	SKT.NM.B4.90	900	560
Blanco Mate 9003	Matt White 9003	SKT.BM.B4.100	1000	560	Negro Mate	Matt Black	SKT.NM.B4.100	1000	560
Blanco Mate 9003	Matt White 9003	SKT.BM.B4.110	1100	560	Negro Mate	Matt Black	SKT.NM.B4.110	1100	560
Blanco Mate 9003	Matt White 9003	SKT.BM.B4.120	1200	560	Negro Mate	Matt Black	SKT.NM.B4.120	1200	560



Balda 3 lados / 3 side board

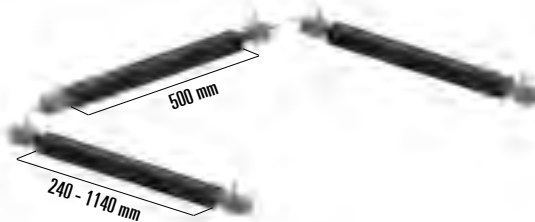

ACABADO	COATED	REF.	ANCHO	FONDO	ACABADO	COATED	REF.	ANCHO	FONDO
Blanco Mate 9003	Matt White 9003	SKT.BM.B3.30	300	560	Negro Mate	Matt Black	SKT.NM.B3.30	300	560
Blanco Mate 9003	Matt White 9003	SKT.BM.B3.40	400	560	Negro Mate	Matt Black	SKT.NM.B3.40	400	560
Blanco Mate 9003	Matt White 9003	SKT.BM.B3.50	500	560	Negro Mate	Matt Black	SKT.NM.B3.50	500	560
Blanco Mate 9003	Matt White 9003	SKT.BM.B3.60	600	560	Negro Mate	Matt Black	SKT.NM.B3.60	600	560
Blanco Mate 9003	Matt White 9003	SKT.BM.B3.70	700	560	Negro Mate	Matt Black	SKT.NM.B3.70	700	560
Blanco Mate 9003	Matt White 9003	SKT.BM.B3.80	800	560	Negro Mate	Matt Black	SKT.NM.B3.80	800	560
Blanco Mate 9003	Matt White 9003	SKT.BM.B3.90	900	560	Negro Mate	Matt Black	SKT.NM.B3.90	900	560
Blanco Mate 9003	Matt White 9003	SKT.BM.B3.100	1000	560	Negro Mate	Matt Black	SKT.NM.B3.100	1000	560
Blanco Mate 9003	Matt White 9003	SKT.BM.B3.110	1100	560	Negro Mate	Matt Black	SKT.NM.B3.110	1100	560
Blanco Mate 9003	Matt White 9003	SKT.BM.B3.120	1200	560	Negro Mate	Matt Black	SKT.NM.B3.120	1200	560



OPCIÓN BALDA CLOCKS / CLOCK BOARD OPTION

Barras verticales de 2,7m + pie y suplemento

2.7 m Vertical profiles + adjustable feet

*MECANIZADOS DE BALDA INCLUIDOS / BOARD MACHINING INCLUDED

ACABADO	COATED	REF.	LONG
Blanco Mate 9003	Matt White 9003	SKT.KIT.L.BM	2,7 m
Negro Mate	Matt Black	SKT.KIT.L.NM	2,7 m

*BALDA NO INCLUIDA / BOARD NOT INCLUDED



Balda A: Balda 2 laterales + clocks / 2 lateral board + clocks

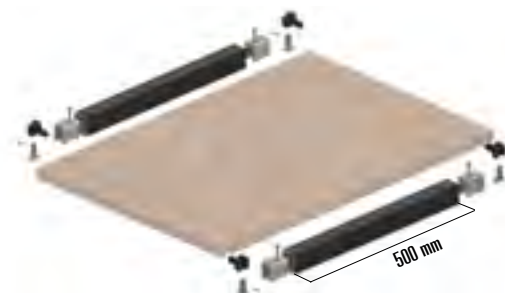

ACABADO	COATED	REF.	ANCHO	FONDO
Blanco Mate 9003	Matt White 9003	SKT.BM.B2L+C	100-1200	560
Negro Mate	Matt Black	SKT.NMB2L+C	100-1200	560

*BALDA NO INCLUIDA / BOARD NOT INCLUDED

Balda B: Balda 1 lateral + clocks / 1 lateral board + clocks

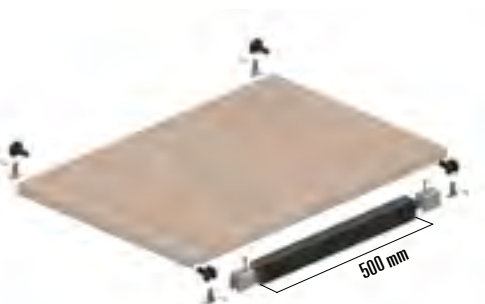

ACABADO	COATED	REF.	ANCHO	FONDO
Blanco Mate 9003	Matt White 9003	SKT.BM.B1L+C	100-1200	560
Negro Mate	Matt Black	SKT.NMB1L+C	100-1200	560

*BALDA NO INCLUIDA / BOARD NOT INCLUDED

Balda C: Clocks



REF.

SKT.200.KIT

*BALDA NO INCLUIDA / BOARD NOT INCLUDED



COMPLEMENTOS DE ARMARIO

CABINET FITTINGS

ESSENTIAL

178

MOKA

184

ESSENTIAL



BARRA COLGADOR

HANGER TUBE



Longitud / Length : 4 m.

REF.
190I.A.PM.4

Espesor = 1,05 mm.
Thickness

BARRA COLGADOR ROBUSTA

HANGER TUBE



Longitud / Length : 4 m.

REF.
190C.A.PM.4

Espesor = 1,3 mm.
Thickness

BARRA COLGADOR CON GOMA

HANGER TUBE WITH PLASTIC PROFILE



Longitud / Length : 4 m.

REF.
195.A.PM.4

Espesor = 1,2 mm.
Thickness

SOPORTE LATERAL

LATERAL TUBE HANGER



REF.	Acabados	Finishings
191.MG.O	Oro	Golden
191.MG.P	Cromado	Nickel Plated
191.MG.PM	Plata Mate	Grey (coated)

SOPORTE LATERAL BCG ROBUSTA

LATERAL TUBE HANGER



REF.	Acabados	Finishings
191.E.P	Cromado	Nickel Plated
191.E.PM	Plata Mate	Grey (coated)

SOPORTE LATERAL CIEGO

LATERAL POLE TUBE HANGER



REF.	Acabados	Finishings
194.CHN.P	Cromado	Nickel Plated
194.CHN.PM	Plata Mate	Grey (coated)

SOPORTE CENTRAL

CENTRAL TUBE HANGER



REF.	Acabados	Finishings
192.MG.O	Oro	Golden
192.MG.P	Cromado	Nickel Plated
192.MG.PM	Plata Mate	Grey (Coated)

SOPORTE LATERAL ALUMINIO

SIDE TUBE HANGER



REF.
1952

NO INCLUYE TORNILLO
SCREW IS NOT INCLUDED

SOPORTE CENTRAL ALUMINIO

CENTRAL TUBE HANGER



REF.
1953

NO INCLUYE TORNILLO
SCREW IS NOT INCLUDED

CINTURONERO - CORBATERO

BELT AND TIE RACK

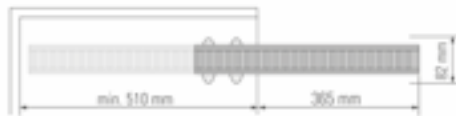

REF.
63CCLE

SOPORTE PERCHA

BELT AND TIE RACK



REF.
64PM/214

CORBATERO - CINTURONERO EXTENSIBLE MANO DERECHA

TIE & BELT PULL-OUT (RIGHT)

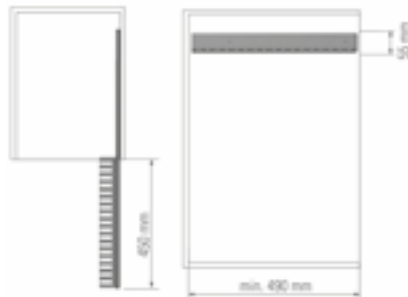

AUTOCIERRE
SELF-LOCK

REF.
66CCMGD

CORBATERO - CINTURONERO EXTENSIBLE MANO IZQUIERDA

TIE & BELT PULL-OUT (LEFT)

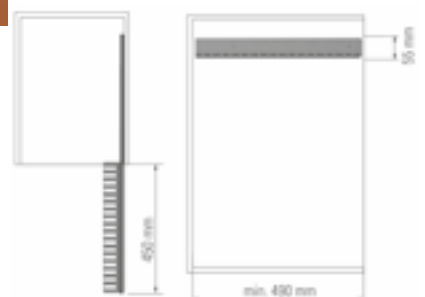

AUTOCIERRE
SELF-LOCK

REF.
66CCMGL

FALDERO LATERAL

SKIRT RACK

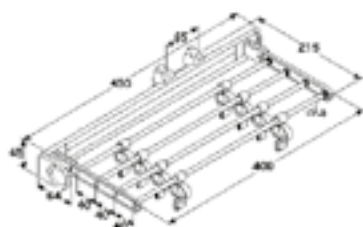

REF.
62FLAE

CINTURONERO - CORBATERO FIJO

BELT AND TIE RACK



REF.
62CMULTI2

ZAPATERO CROMADO EXTENSIBLE CON FRENTE

SHOE RACK

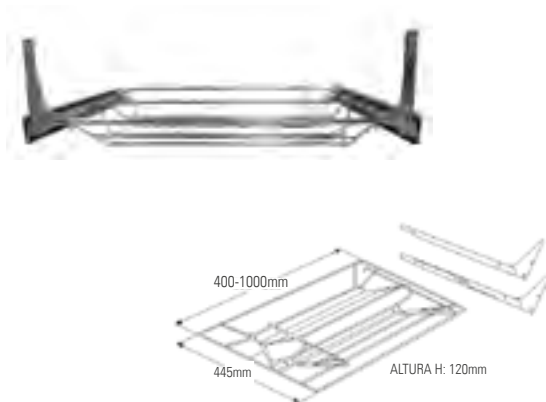

REF.	L
65ZG/40-60	400 - 600 mm.
65ZG/50-80	500 - 800 mm.
65ZG/80-100	800 - 1000 mm.

ZAPATERO FIJO

SHOE RACK

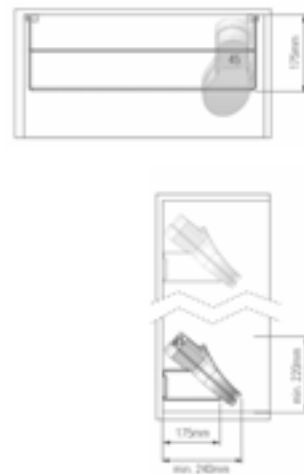
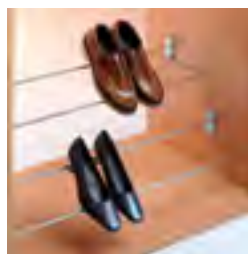

REF.	L
65ZF/45-62	450 - 620 mm.
65ZF/62-79	620 - 790 mm.
65ZF/79-96	790 - 960 mm.

PANTALONERO DOBLE

TROUSERS RACK 18 HANGERS

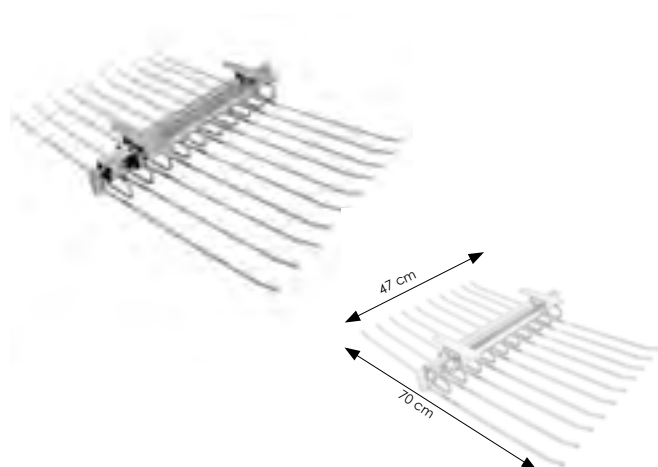

REF.
61PERD/18

PANTALONERO 11 PERCHAS GOMOSO

TROUSER RACK

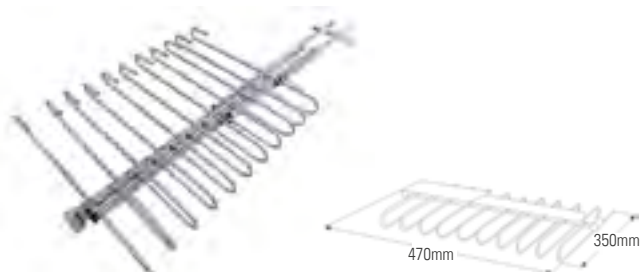

PERCHA ANTIDESLIZANTE

REF.
61PERGOM/11

PANTALONERO 9 PERCHAS + VACIA BOLSILLOS

TROUSERS RACK

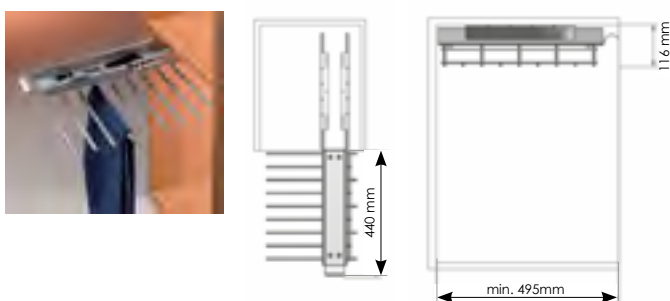

CIERRE AMORTIGUADO. BANDEJA PORTA-OBJETOS
PERCHA ANTIDESLIZANTE

REF.
61PASCB9P

PANTALONERO 18 PERCHAS + VACIA BOLSILLOS

TROUSERS RACK

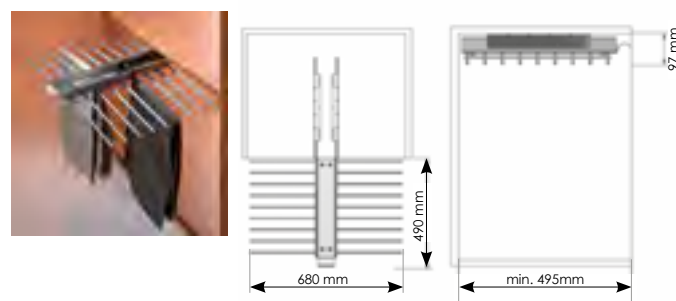

CIERRE AMORTIGUADO. BANDEJA PORTA-OBJETOS
PERCHA ANTIDESLIZANTE

REF.
61PADBCB18P

PANTALONERO DE ALUMINIO 600 y 800mm.

ALUMINIUM TROUSERS RACK

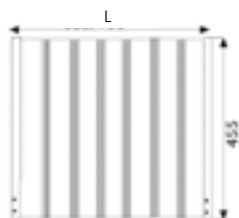

REF.	L
61PAE/600	533
61PAE/800	733

JUEGO SOPORTE ZAPATERO EXTRAIBLE - EXTENSIBLE

SHOE RACK



REF.	L
68JC/40-50	400-500mm.
68JC/50-60	500-600mm.
68JC/60-70	600-700mm.
68JC/80-90	800-900mm.
68JC/90-100	900-1000mm.

CIERRE AMORTIGUADO
GUÍA CUADRO HETTICH

SOPORTE PERCHAS EXTENSIBLE

PULL OUT HANGER

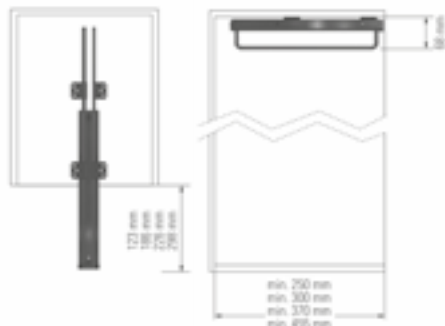
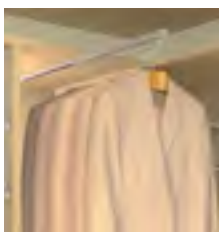

REF.	L
67PE/240	240mm.
67PE/290	290mm.
67PE/360	360mm.
67PE/445	445mm.

SOPORTE PERCHAS EXTENSIBLE

PULL OUT HANGER



REF.	L
67PE.ES/300	300mm.
67PE.ES/350	350mm.
67PE.ES/400	400mm.
67PE.ES/450	450mm.

ESPEJO EXTRAÍBLE ABATIBLE

FOLDING - EXTRAIBLE MIRROR

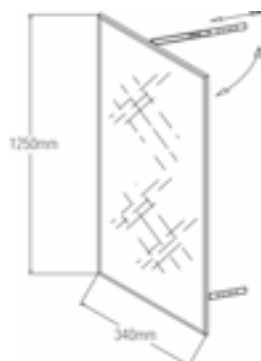

REF.
67ESP

PERCHA DE MADERA

WOOD HANGER



REF.
66PML

PERCHERO ABATIBLE

HYDRAULIC LIFT-UP



REF.	L
64PA/45-60	450 - 600 mm
64PA/60-83	600 - 830 mm
64PA/83-115	830 - 1150 mm

PERCHERO ABATIBLE SERVETTO

HYDRAULIC LIFT-UP

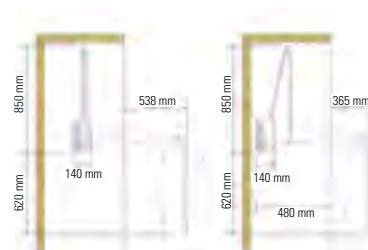

REF.	L
64PAS/44-61	440-610mm.
64PAS/61-100	610-1000mm.
64PAS/77-120	770-1200mm.

JUEGO BANDEJA EXTRAIBLE - EXTENSIBLE

PULL OUT BASKET



CIERRE AMORTIGUADO
GUÍA CUADRO HETTICH

REF.	L
68JCE/40-50	400-500mm.
68JCE/50-60	500-600mm.
68JCE/60-70	600-700mm.
68JCE/70-80	700-800mm.
68JCE/80-90	800-900mm.
68JCE/90-1000	900-1000mm.

JUEGO BALDA EXTRAIBLE

PULL OUT SHELF

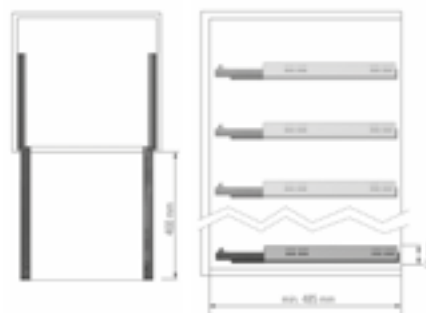

CIERRE AMORTIGUADO
GUÍA CUADRO HETTICH

REF.
68JB

GUÍA INFERIOR GIAE

GIAE LOWER RAIL

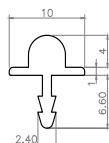

REF.	Acabados	Finishings
129.A.PM	Plata Mate	Silver Painted

MOKA



BANDEJA MULTIFUNCION COMPARTIMENTOS EXTENSIBLE

MULTIFUNCTIONAL TRAY WITH COMPARTMENTS, ADJUSTABLE WIDTH



REF.	MEDIDAS (Ancho x fondo x alto) / MEASURES (Width x depth x height)
61.BMCO.500	464 - 514mm x 485 x 70
61.BMCO.600	564 - 614mm x 485 x 70
61.BMCO.700	664 - 714mm x 485 x 70
61.BMCO.800	764 - 814mm x 485 x 70
61.BMCO.900	864 - 914mm x 485 x 70
61.BMCO.1000	964 - 1014mm x 485 x 70

BANDEJA MULTIFUNCION CON CAJAS EXTENSIBLE

MULTIFUNCTIONAL TRAY WITH BOXES, ADJUSTABLE WIDTH



REF.	MEDIDAS (Ancho x fondo x alto) / MEASURES (Width x depth x height)
61.BMCA.700	664 - 714mm x 485 x 70
61.BMCA.800	764 - 814mm x 485 x 70
61.BMCA.900	864 - 914mm x 485 x 70
61.BMCA.1000	964 - 1014mm x 485 x 70

CESTA RATTAN EXTENSIBLE

RATTAN BASKET ADJUSTABLE WIDTH



REF.	MEDIDAS (Ancho x fondo x alto) / MEASURES (Width x depth x height)
62.CR.500	464 - 514mm x 485 x 165
62.CR.600	564 - 614mm x 485 x 165
62.CR.700	664 - 714mm x 485 x 165
62.CR.800	764 - 814mm x 485 x 165
62.CR.900	864 - 914mm x 485 x 165
62.CR.1000	964 - 1014mm x 485 x 165

BANDEJA METÁLICA EXTENSIBLE 130mm DE PROFUNDIDAD

METALLIC TRAY 130mm. DEPTH ADJUSTABLE WIDTH



REF.	MEDIDAS (Ancho x fondo x alto) / MEASURES (Width x depth x height)
62.BM.500	464 - 514mm x 485 x 140
62.BM.600	564 - 614mm x 485 x 140
62.BM.700	664 - 714mm x 485 x 140
62.BM.800	764 - 814mm x 485 x 140
62.BM.900	864 - 914mm x 485 x 140
62.BM.1000	964 - 1014mm x 485 x 140

SPORTE PERCHAS EXTENSIBLE

EXTENSIBLE PULLOUT ROD



REF.	MEDIDAS / MEASURES
66.SPEX	445mm. (160mm altura / 160mm height)

CORBATERO - CINTURONERO AMOR. IZQUIERDA / DERECHA

TIES & BELTS RACK SOFT CLOSE, REVERSIBLE



REF.	MEDIDAS / MEASURES
67.CCEX	445mm.

SOPORTE LATERAL RECTANGULAR MOKA

RECTANGULAR LATERAL SUPPORT



ACABADOS	FINISHINGS	REF.
Blanco Mate	Mat White	1954BM
Negro Mate	Mat Black	1954NM
Plata Mate	Natural Anodized	1954PM
Moka	Moka	1954MK
Antracita	Anthracite	1954ANT

SOPORTE LATERAL MOKA

RECTANGULAR LATERAL SUPPORT



ACABADOS	FINISHINGS	REF.
Blanco Mate	Mat White	1955BM
Negro Mate	Mat Black	1955NM
Plata Mate	Natural Anodized	1955PM
Moka	Moka	1955MK
Antracita	Anthracite	1955ANT

SOPORTE CENTRAL MOKA

RECTANGULAR CENTRAL SUPPORT



ACABADOS	FINISHINGS	REF.
Blanco Mate	Mat White	1956BM
Negro Mate	Mat Black	1956NM
Plata Mate	Natural Anodized	1956PM
Moka	Moka	1956MK
Antracita	Anthracite	1956ANT

SOPORTES IZQUIERDO Y DERECHO MOKA

RECTANGULAR LEFT AND RIGHT LATERAL SUPPORT

NOVEDAD / NEW



ACABADOS	FINISHINGS	REF.
Blanco Mate	Mat White	1957BM
Negro Mate	Mat Black	1957NM
Plata Mate	Natural Anodized	1957PM
Moka	Moka	1957MK
Antracita	Anthracite	1957ANT

PANTALONERO BARRAS - GOMAS DESPLAZABLE EXTENSIBLE

PANTS HANGER NON SLIPPERY, REMOVABLE, ADJUSTABLE WIDTH



REF.	MEDIDAS (Ancho x fondo x alto) / MEASURES (Width x depth x height)
63.PAPG.500	464 - 514mm x 485 x 60
63.PAPG.600	564 - 614mm x 485 x 60
63.PAPG.700	664 - 714mm x 485 x 60
63.PAPG.800	764 - 814mm x 485 x 60
63.PAPG.900	864 - 914mm x 485 x 60
63.PAPG.1000	964 - 1014mm x 485 x 60

CLIPS FRENTE COMPLEMENTOS MOKA

FRONT MOKA ACCESSORIES CLIPS

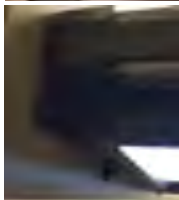

REF.

61.CLIP

PERCHERO ABATIBLE MOKA SERVETTO

HYDRAULIC MOKA LIFT-UP



REF.	L
64PA.MK/45-60	450-600mm.
64PA.MK/60-83	600-830mm.
64PA.MK/83-115	830-1150mm.

BARRA DE COLGAR RECTANGULAR CURVADA (1m+1m)

90° RECTANGULAR HANGER TUBE



ACABADOS	FINISHINGS	REF.
Blanco Mate	Mat White	196.CRVO.L.BM
Negro Mate	Mat Black	196.CRVO.L.NM
Plata Mate	Natural Anodized	196.CRVO.A.PM
Moka	Moka	196.CRVO.L.MK
Antracita	Anthracite	196.CRVO.L.ANT

BARRA DE COLGAR RECTANGULAR CON GOMA COLOR MOKA

RECTANGULAR MOKA HANGER TUBE



Longitud / Length : 4 m.

ACABADOS	FINISHINGS	REF.
Blanco Mate	Mat White	196.L.BM
Negro Mate	Mat Black	196.L.NM
Plata Mate	Natural Anodized	196.A.PM
Moka	Moka	196.L.MK
Antracita	Anthracite	196.L.ANT

JUEGO VARILLAS PANTALONERO (4 un)

SET OF TROUSERS RODS (4 un)



REF.
63.PAPG.4

DISTANCIADOR

DRAWER GASKET



REF.
61.DIS

ZAPATERO GIRATORIO

SWIVEL SHOE RACK

Anchura mínima / Minimum width :750 mm
 Altura / High: 1910 - 2250 mm
 Fondo mínimo / Minimum depth: 400 mm



REF.
64ZPM.RT

ZAPATERO CON BASE METÁLICA EXTENSIBLE

SHOE RACK WITH METAL BASE, ADJUSTABLE WIDTH



REF.	MEDIDAS (Ancho x fondo x alto) / MEASURES (Width x depth x height)
64.ZPM.500	464 - 514mm x 485 x 190
64.ZPM.600	564 - 614mm x 485 x 190
64.ZPM.700	664 - 714mm x 485 x 190
64.ZPM.800	764 - 814mm x 485 x 190
64.ZPM.900	864 - 914mm x 485 x 190
64.ZPM.1000	964 - 1014mm x 485 x 190

ESPEJO EXTRAIBLE GIRATORIO CON COMPARTIMENTOS

PULLOUT SWING MIRROR WITH COMPARTMENTS



REF.	MEDIDAS / MEASURES
65.ESEG	1130x415mm.

CAJON MOKA

NOVEDAD / NEW

COSTADOS DE CAJON + GUÍAS (Extracción total y cierre amortiguador)

MOKA DRAWER (FULL EXTENSION AND SOFT CLOSING SLIDES)



FIJACIÓN FRENTE INCLUIDA
FRONT PANNEL JOINT INCLUDED

REF.	MEDIDAS / MEASURES	PROFUNDIDAD	ALTURA INTERIOR LIBRE
CMSE.58	106mm.	450mm.	58mm.



FIJACIÓN FRENTE INCLUIDA
FRONT PANNEL JOINT INCLUDED

REF.	MEDIDAS / MEASURES	PROFUNDIDAD	ALTURA INTERIOR LIBRE
CMSE.112	160mm.	450mm.	112mm.
CMSE.144	192mm.	450mm.	144mm.

COSTADOS DE CAJON + GUÍAS (Extracción total y cierre amortiguado) + FRENTE CAJON (1200mm)

MOKA DRAWER WITH FRONT ALUMINIUM PANNEL (FULL EXTENSION AND SOFT CLOSING SLIDES)

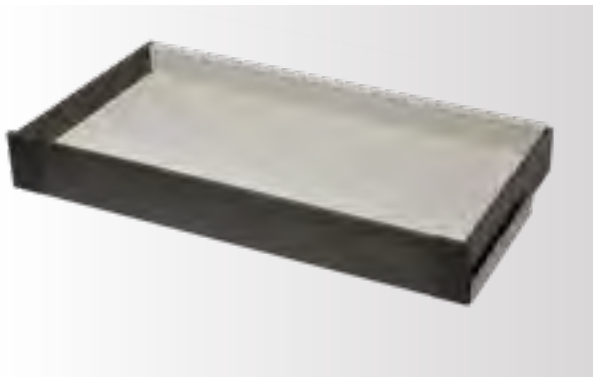

REF.	MEDIDAS / MEASURES	PROFUNDIDAD	ALTURA INTERIOR LIBRE
CMCF.58	106mm.	450mm.	58mm.



REF.	MEDIDAS / MEASURES	PROFUNDIDAD	ALTURA INTERIOR LIBRE
CMCF.112	160mm.	450mm.	112mm.
CMCF.144	192mm.	450mm.	144mm.

SISTEMAS CORREDEROS COLGANTES

HANGING DOOR SYSTEMS

SKY

190

SKY INOX MADERA

199

SKY INOX VIDRIO

200

SKY RUSTICO

201

SKY

SKY

ADINOR

GUIA SUPERIOR A TECHO BASIC

CEILING BASIC UPPER TRACK

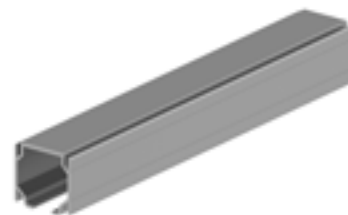
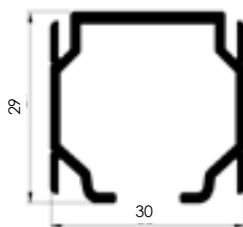

6m. Condiciones especiales de envío
6m. Special shipping conditions

ACABADOS	FINISHINGS	2 m.	3 m.	4 m.	6 m.
ANODIZADOS	ANODIZED	REF.	REF.	REF.	REF.
Natural	Natural	SK110.A.N.2	SK110.A.N.3	SK110.A.N.4	SK110.A.N.6
Plata Mate	Natural Anodized	SK110.A.PM.2	SK110.A.PM.3	SK110.A.PM.4	SK110.A.PM.6

GUIA SKY MIDI

MIDI UPPER TRACK

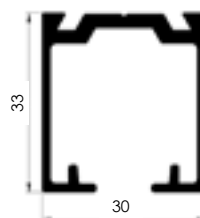

ACABADOS	FINISHINGS	2 m.	3 m.	4 m.	6 m.
ANODIZADOS	ANODIZED	REF.	REF.	REF.	REF.
Natural	Natural	SK114.A.N.2	SK114.A.N.3	SK114.A.N.4	SK114.A.N.6
Plata Mate	Natural Anodized	SK114.A.PM.2	SK114.A.PM.3	SK114.A.PM.4	SK114.A.PM.6

SKY

ADINOR

GUIA A PARED

WALL UPPER TRACK

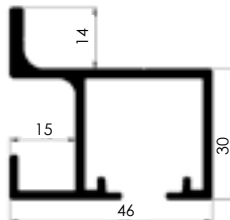

6m. Condiciones especiales de envío

6m. Special shipping conditions

ACABADOS	FINISHINGS	2 m.	3 m.	4 m.	6 m.
ANODIZADOS	ANODIZED	REF.	REF.	REF.	REF.
Natural	Natural	-	-	-	-
Plata Mate	Natural Anodized	SK115.A.PM.2	SK115.A.PM.3	SK115.A.PM.4	SK115.A.PM.6

GUIA TECHO PLADUR

PLASTERBOARD UPPER TRACK

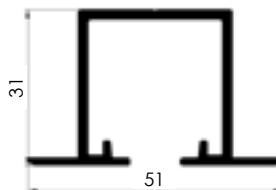

ACABADOS	FINISHINGS	2 m.	3 m.	4 m.	6 m.
ANODIZADOS	ANODIZED	REF.	REF.	REF.	REF.
Natural	Natural	-	-	-	-
Plata Mate	Natural Anodized	SK116.A.PM.2	SK116.A.PM.3	SK116.A.PM.4	SK116.A.PM.6

GUIA TECHO PLUS

CEILING PLUS UPPER TRACK

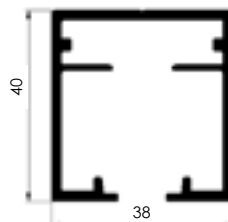

ACABADOS	FINISHINGS	2 m.	3 m.	4 m.	6 m.
ANODIZADOS	ANODIZED	REF.	REF.	REF.	REF.
Natural	Natural	-	-	-	-
Plata Mate	Natural Anodized	SK111.A.PM.2	SK111.A.PM.3	SK111.A.PM.4	SK111.A.PM.6
LACADOS	COATED	REF.	REF.	REF.	REF.
Blanco Mate RAL 9003	Mat White RAL 9003	SK111.L.BM.2	SK111.L.BM.3	SK111.L.BM.4	SK111.L.BM.6
Negro Mate	Mat Black	SK111.L.NM.2	SK111.L.NM.3	SK111.L.NM.4	SK111.L.NM.6
Moka	Moka	SK111.L.MK.2	SK111.L.MK.3	SK111.L.MK.4	SK111.L.MK.6
Repintable	Pre-paint	SK111.L.T.2	SK111.L.T.3	SK111.L.T.4	SK111.L.T.6

GUIA PARED PLUS

WALL PLUS UPPER TRACK

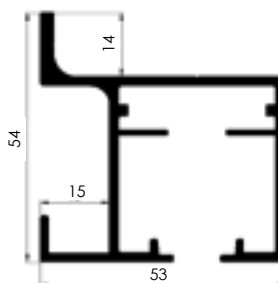

ACABADOS	FINISHINGS	2 m.	3 m.	4 m.	6 m.
ANODIZADOS	ANODIZED	REF.	REF.	REF.	REF.
Natural	Natural	-	-	-	-
Plata Mate	Natural Anodized	SK112.A.PM.2	SK112.A.PM.3	SK112.A.PM.4	SK112.A.PM.6
LACADOS	COATED	REF.	REF.	REF.	REF.
Blanco Mate RAL 9003	Mat White RAL 9003	SK112.L.BM.2	SK112.L.BM.3	SK112.L.BM.4	SK112.L.BM.6
Negro Mate	Mat Black	SK112.L.NM.2	SK112.L.NM.3	SK112.L.NM.4	SK112.L.NM.6
Moka	Moka	SK112.L.MK.2	SK112.L.MK.3	SK112.L.MK.4	SK112.L.MK.6
Repintable	Pre-paint	SK112.L.T.2	SK112.L.T.3	SK112.L.T.4	SK112.L.T.6

6m. Condiciones especiales de envío
6m. Special shipping conditions

GUIA SUPERIOR PARA PLADUR PLUS

PLASTERBOARD UPPER TRACK PLUS

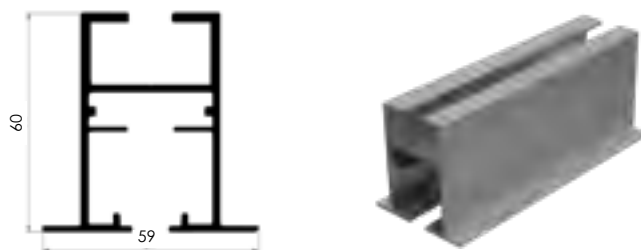

ACABADOS	FINISHINGS	2 m.	3 m.	4 m.	6 m.
ANODIZADOS	ANODIZED	REF.	REF.	REF.	REF.
Natural	Natural	-	-	-	-
Plata Mate	Natural Anodized	SK113.A.PM.2	SK113.A.PM.3	SK113.A.PM.4	SK113.A.PM.6
LACADOS	COATED	REF.	REF.	REF.	REF.
Blanco Mate RAL 9003	Mat White RAL 9003	SK113.L.BM.2	SK113.L.BM.3	SK113.L.BM.4	SK113.L.BM.6
Negro Mate	Mat Black	SK113.L.NM.2	SK113.L.NM.3	SK113.L.NM.4	SK113.L.NM.6
Moka	Moka	SK113.L.MK.2	SK113.L.MK.3	SK113.L.MK.4	SK113.L.MK.6
Repintable	Pre-paint	SK113.L.T.2	SK113.L.T.3	SK113.L.T.4	SK113.L.T.6

GUIA PARA PLADUR PLUS DOBLE

PLASTERBOARD DOUBLE UPPER TRACK PLUS

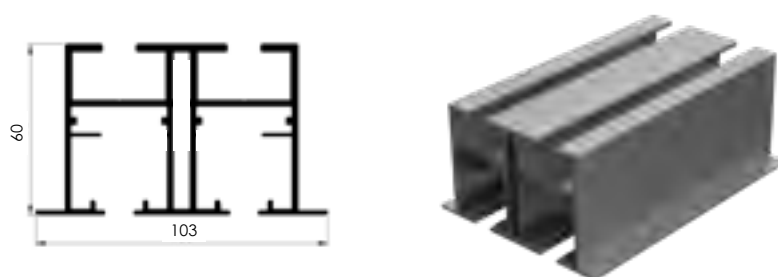

ACABADOS	FINISHINGS	2 m.	3 m.	4 m.	6 m.
ANODIZADOS	ANODIZED	REF.	REF.	REF.	REF.
Natural	Natural	-	-	-	-
Plata Mate	Natural Anodized	SK1135.A.PM.2	SK1135.A.PM.3	SK1135.A.PM.4	SK1135.A.PM.6
LACADOS	COATED	REF.	REF.	REF.	REF.
Blanco Mate RAL 9003	Mat White RAL 9003	SK1135.L.BM.2	SK1135.L.BM.3	SK1135.L.BM.4	SK1135.L.BM.6
Negro Mate	Mat Black	SK1135.L.NM.2	SK1135.L.NM.3	SK1135.L.NM.4	SK1135.L.NM.6
Moka	Moka	SK1135.L.MK.2	SK1135.L.MK.3	SK1135.L.MK.4	SK1135.L.MK.6
Repintable	Pre-paint	SK1135.L.T.2	SK1135.L.T.3	SK1135.L.T.4	SK1135.L.T.6

COMPLEMENTOS

COMPLEMENTS

CARRO SKY MADERA 60kg

60kg WOOD SKY ROLLER

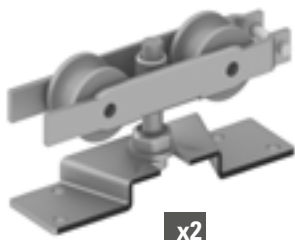

x2



x2



x1

REF.

SK.C.60

CARRO SKY MADERA 120kg

120kg WOOD SKY ROLLER



x2



x2



x1

REF.

SK.C.120

RETRAC SKY MADERA 60kg

60kg WOOD SKY RETRAC ROLLER



x2



x2



x2



x1

REF.

SK.CR.60

RETRAC SKY MADERA 120kg

120kg WOOD SKY RETRAC ROLLER



x2



x2



x2



x1

REF.

SK.CR.120

KIT AMORTIGUADOR SKY 40kg

SKY SOFT-CLOSING SYSTEM UP TO 40kg



REF.

SK.AMORT.40

Solo válido para guías plus
Only valid for plus tracks

KIT AMORTIGUADOR SKY 60kg CORTO

SKY SOFT-CLOSING SYSTEM UP TO 60kg SMALL



REF.

SK.AMORT.60P

Solo válido para guías plus
Only valid for plus tracks

KIT AMORTIGUADOR SKY 60kg

SKY SOFT-CLOSING SYSTEM UP TO 60kg



REF.

SK.AMORT.60

Solo válido para guías plus
Only valid for plus tracks

KIT AMORTIGUADOR SKY 80kg

SKY SOFT-CLOSING SYSTEM UP TO 80kg



REF.

SK.AMORT.80

Solo válido para guías plus
Only valid for plus tracks

KIT AMORTIGUADOR SKY 100kg

SKY SOFT-CLOSING SYSTEM UP TO 100kg



REF.

SK.AMORT.100

Solo válido para guías plus
Only valid for plus tracks

KIT AMORTIGUADOR SKY 120kg

SKY SOFT-CLOSING SYSTEM UP TO 120kg



REF.

SK.AMORT.120

Solo válido para guías plus
Only valid for plus tracks

KIT AMORTIGUADOR BIDIRECCIONAL SKY 60kg

SKY SOFT-CLOSING SYSTEM UP TO 60kg

NOVEDAD / NEW



REF.

SK.AMBID.60

Solo válido para guías plus
Only valid for plus tracks

KIT AMORTIGUADOR BIDIRECCIONAL SKY 80kg

SKY SOFT-CLOSING SYSTEM UP TO 80kg

NOVEDAD / NEW



REF.

SK.AMBID.80

Solo válido para guías plus
Only valid for plus tracks

KIT AMORTIGUADOR BIDIRECCIONAL SKY 100kg

SKY SOFT-CLOSING SYSTEM UP TO 100kg

NOVEDAD / NEW



REF.

SK.AMBID.100

Solo válido para guías plus
Only valid for plus tracks

KIT AMORTIGUADOR BIDIRECCIONAL SKY 120kg

SKY SOFT-CLOSING SYSTEM UP TO 120kg

NOVEDAD / NEW



REF.

SK.AMBID.120

Solo válido para guías plus
Only valid for plus tracks

ESCUADRA 7,5 mm GUÍA MIDI

7,5 mm ANGLE FOR MIDI TRACK

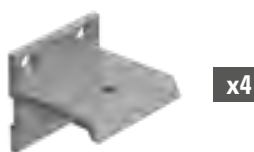

x4

REF.

SK114.AG.1

ESCUADRA 17,5 mm GUÍA MIDI

17,5mm ANGLE FOR MIDI TRACK

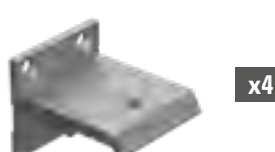

x4

REF.

SK114.AG.2

ESCUADRA PARA GUÍA BÁSIC

ANGLE FOR BASIC TRACK



x1

REF.

SK111.AG

TAPETA GUÍA A PARED PLUS

END COVER FOR WALL PLUS UPPER TRACK

Solo válido para guía plus pared
Only valid for wall plus upper track



LACADOS	COATED	REF.
Blanco mate	Mat White	SK.COV.112.B
Negro mate	Mat Black	SK.COV.112.NM
Moka	Moka	SK.COV.112.MK
Repintable	Pre-paint	SK.COV.112
Plata mate	Natural Anodized	SK.COV.112.PM

KIT ESCUADRA PARA EMBELLECEDOR GUÍA MIDI

SET FOR TRIM COVER

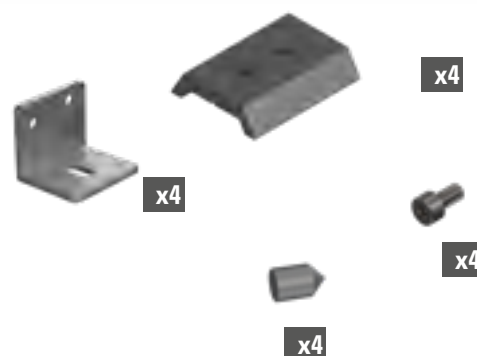

x4

x4

x4

x4

REF.

SK114.ES

SOPORTE ANCLAJE TECHO GUÍA PLADUR PLUS

SINGLE HANGER BRACKET

PARA MONTAJE GUIA PLADUR
SIMPLE Y DOBLE

FOR LAMINATED PLASTBOARD
SINGLE AND DOUBLE TRACK



REF.

SK.ST.113

SOPORTE ANCLAJE TECHO TRIPLE GUÍA PLADUR PLUS

DOUBLE HANGER BRACKET

PARA MONTAJE GUIA PLADUR
TRIPLE

FOR LAMINATED PLASTBOARD
TRIPLE TRACK



REF.

SK.ST3.113

SOPORTE ANCLAJE TECHO CUÁDRUPLE GUÍA PLADUR PLUS

DOUBLE HANGER BRACKET

PARA MONTAJE GUIA PLADUR
CUÁDRUPLE

FOR LAMINATED PLASTBOARD
QUAD TRACK



REF.

SK.ST4.113

KIT GUIAS PARED PLUS + RETRAC SKY MADERA 60Kg

WALL PLUS UPPER TRACK + 60kg WOOD SKY RETRAC ROLLER

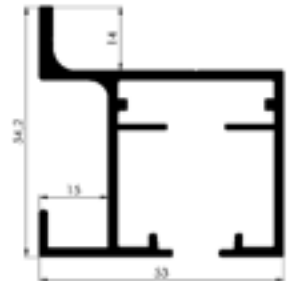
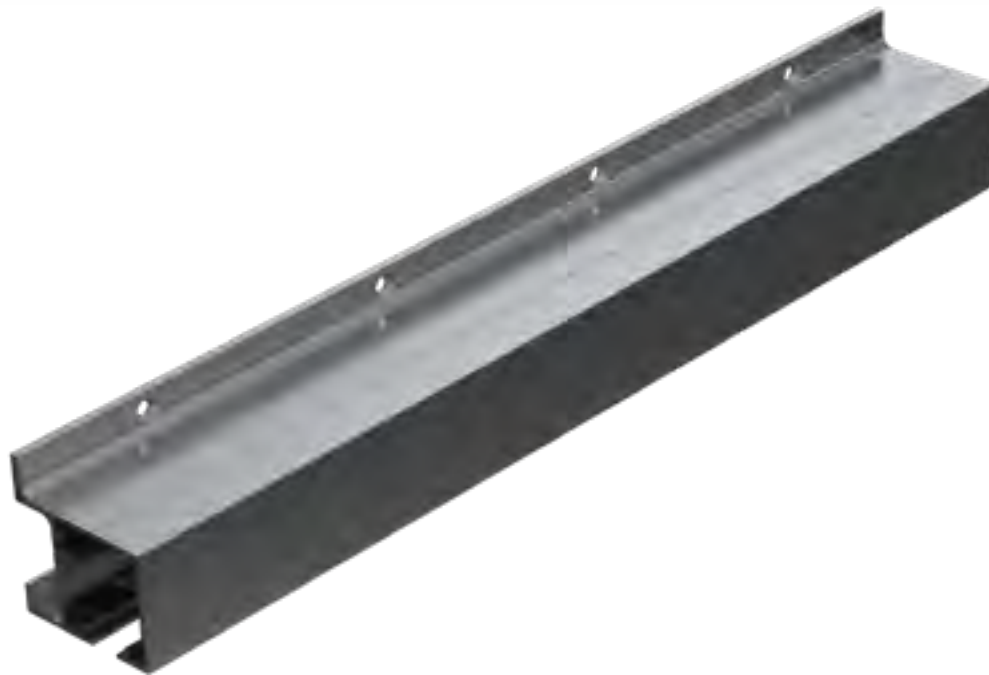

x2



x2



x2

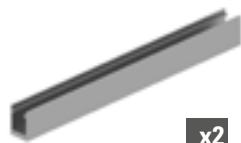

x2



x1

ACABADOS	FINISHINGS	2 m.	3 m.
ANODIZADOS	ANODIZED	REF.	REF.
Plata Mate	Natural Anodized	SK.KGPA.PM.2	SK.KGPA.PM.3
LACADOS	COATED	REF.	REF.
Blanco Mate RAL 9003	Mat White RAL 9003	SK.KGPL.BM.2	SK.KGPL.BM.3
Negro Mate	Mat Black	SK.KGPL.NM.2	SK.KGPL.NM.3
Moka	Moka	SK.KGPL.MK.2	SK.KGPL.MK.3
Repintable	Pre-paint	SK.KGPL.T.2	SK.KGPL.T.3

SKY INOX MADERA

WOOD INOX SKY



REF.

SK.INOX.MD

KIT EXTENSIÓN INOX

SKY INOX EXTENSION



1m

REF.

SK.INOX.CONECT

INSTRUCCIONES DE MONTAJE

ASSEMBLY INSTRUCTIONS

Kit puerta inox madera 80kg. Tubo Ø 25mm
80kg heavy duty inox wood set. 25mm Ø tube

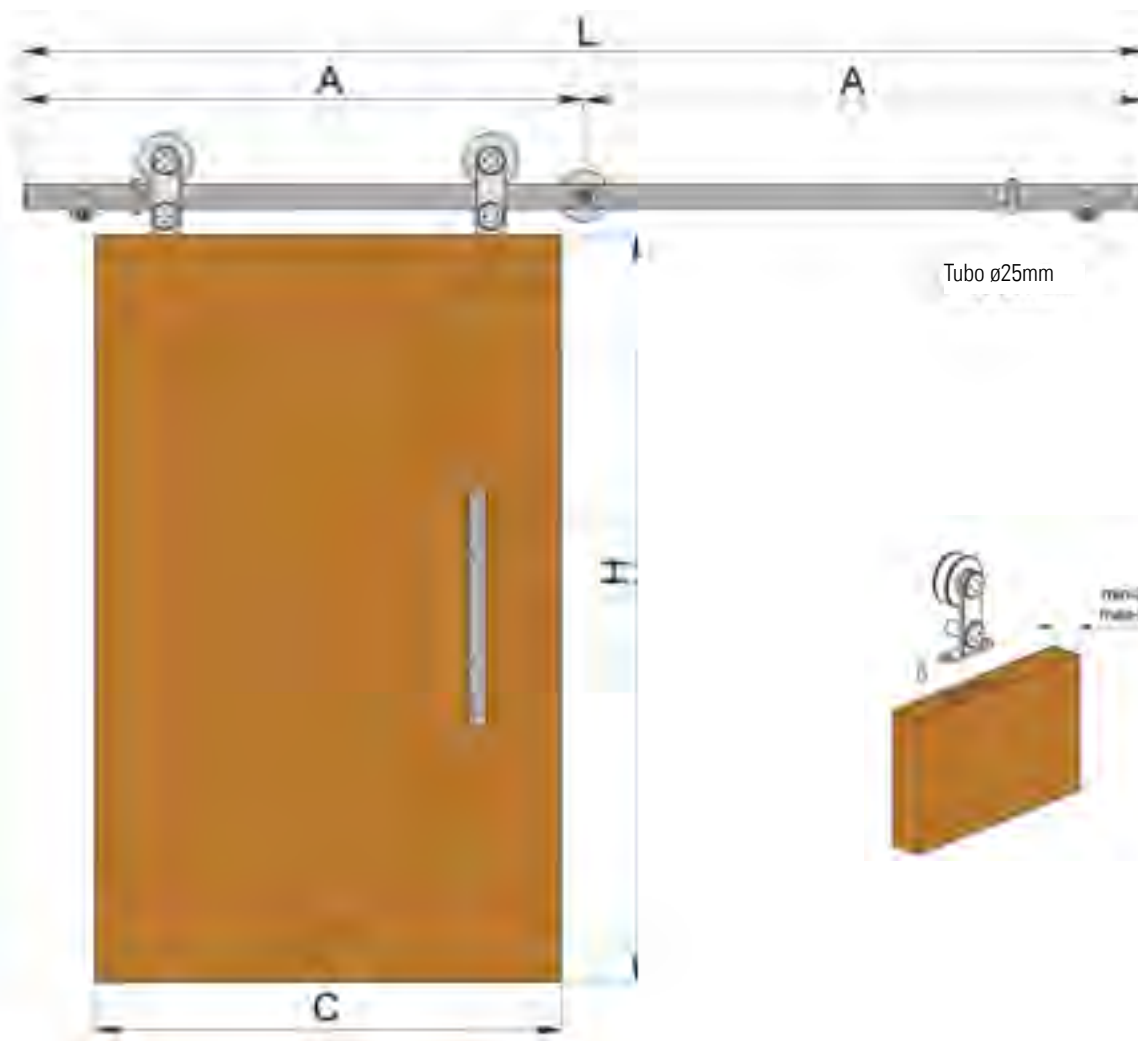

SKY INOX VIDRIO

GLASS INOX SKY



REF.

SK.INOX.V

KIT EXTENSIÓN INOX

SKY INOX EXTENSION



REF.

SK.INOX.CONNECT

INSTRUCCIONES DE MONTAJE

ASSEMBLY INSTRUCTIONS

Kit puerta inox vidrio 100kg. Tubo \varnothing 25mm
100kg heavy duty inox glass set. 25mm \varnothing tube

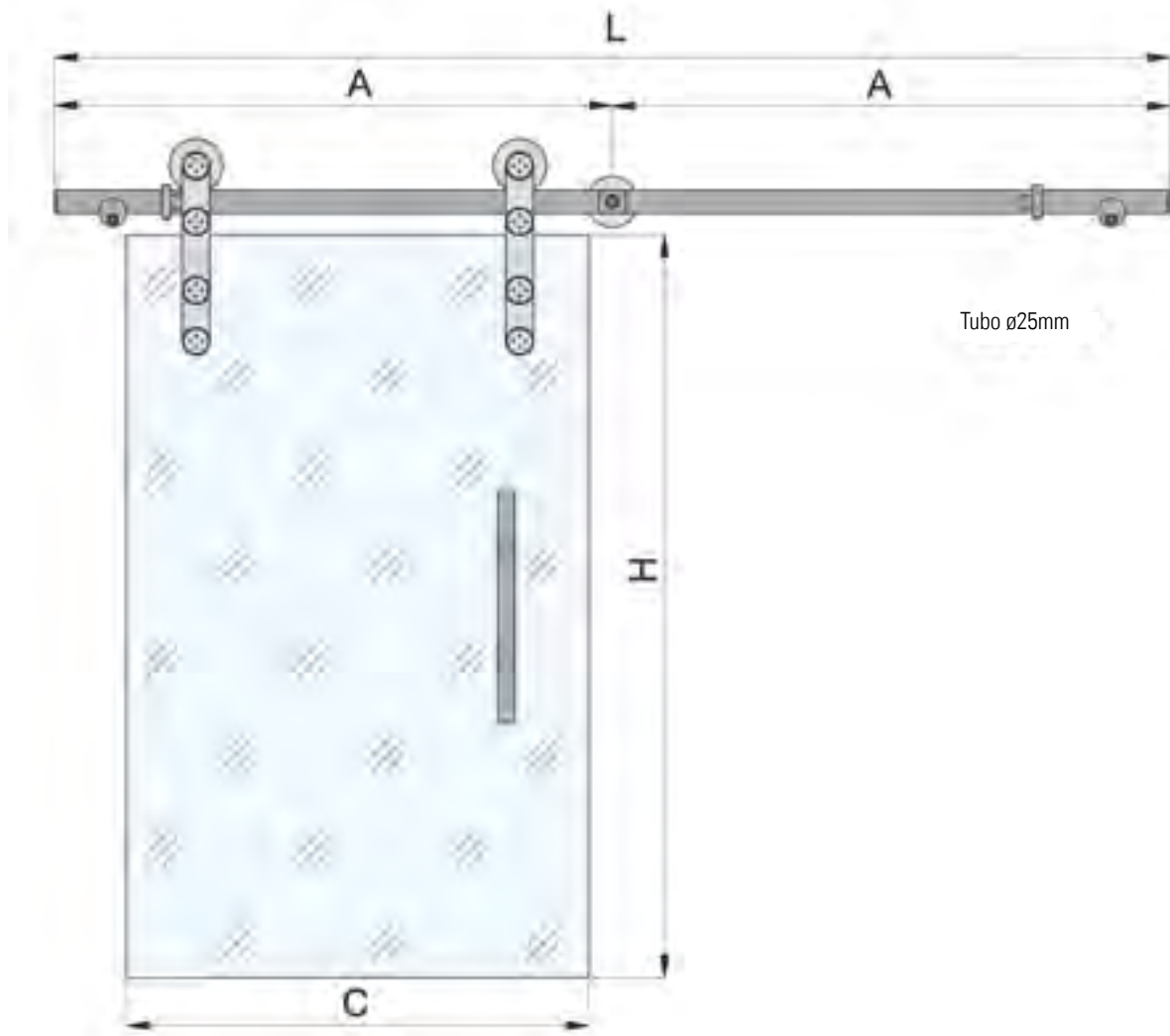

SKY RÚSTICO

SKY RUSTICO MADERA

RUSTIC SKY

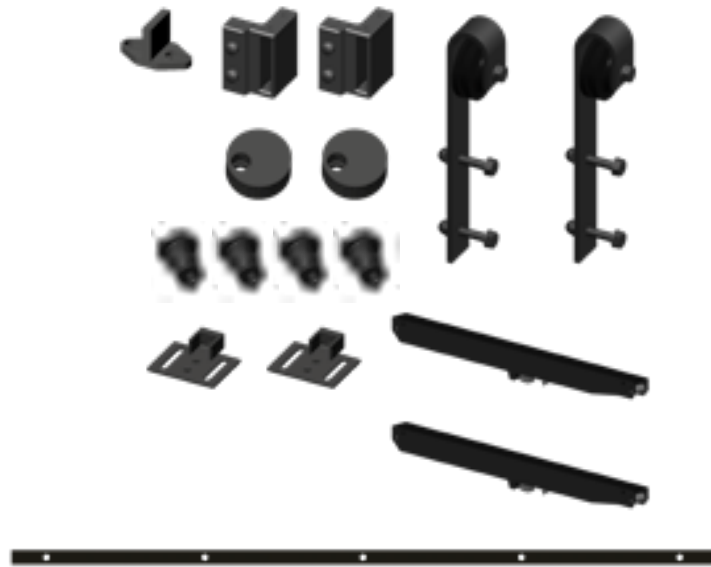

REF.

SK.RUST.MD

JUEGO TIRADOR DAMA

DAMA HANDLE SET



REF.

SK.DAMA

INSTRUCCIONES DE MONTAJE

ASSEMBLY INSTRUCTIONS

Kit puerta rústica 120kg.
120kg heavy duty rustic set.

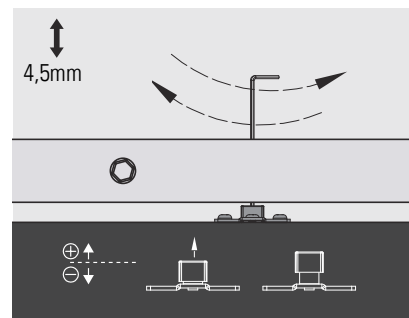
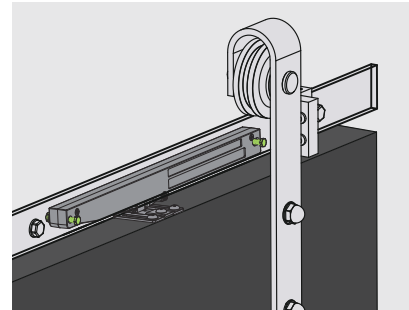
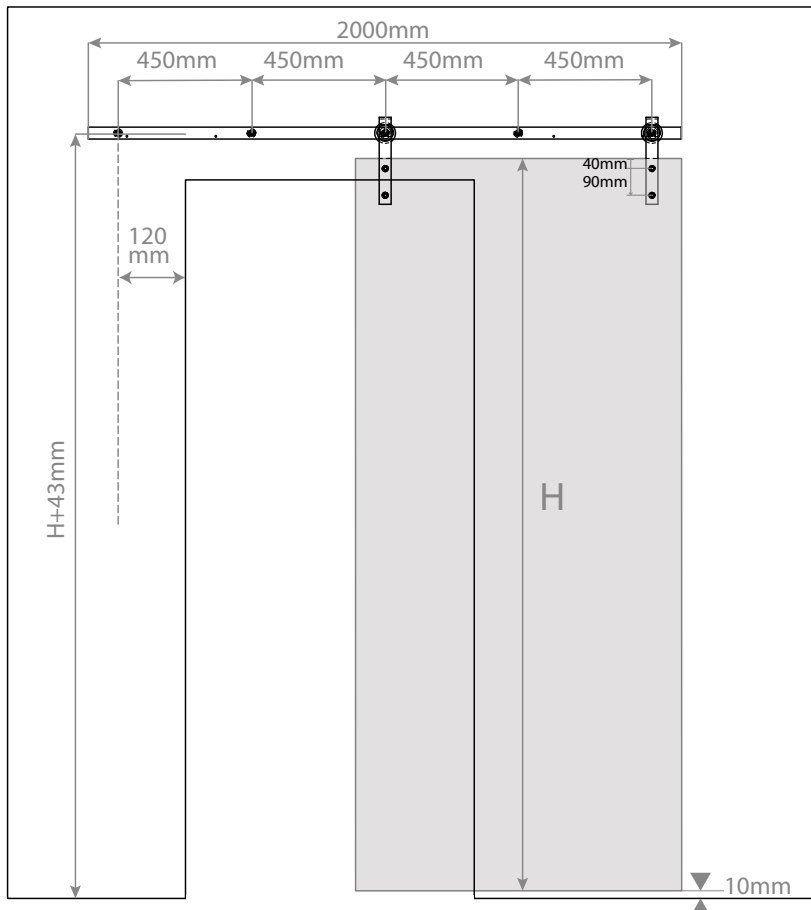

A photograph of a modern wooden cabinet with a light-colored wood grain. The cabinet features a floating shelf and a black metal bar. A bright, warm light is emitted from a recessed channel in the cabinet, creating a strong glow and highlighting the wood's texture. The text 'ILUMINACIÓN' and 'LIGHTING' is overlaid on the image.

ILUMINACIÓN

LIGHTING

TIRAS LED Y COMPLEMENTOS

LED STRIPES AND COMPLEMENTS

ADINOR

TIRA LED FLEXIBLE 18W

FLEXIBLE LED STRIP

3m	3m
4000K	4000K
Anchura 10mm	Width 10mm
60 Led por metro, 18W cada 3m.	60 Led per meter, 18W every 3m.
IP20	IP20
12V	12V
2 lados con conexión	2 sides whit connection.
2m de cable para conexión.	2m cable for connection



REF.
L.AFS35-60

TIRA LED FLEXIBLE 36W

FLEXIBLE LED STRIP

3m	3m
4000K	4000K
Anchura 10mm	Width 10mm
60 Led por metro, 36W cada 3m	60 Led per meter, 36W every 3m.
IP20	IP20
12V	12V
2 lados con conexión	2 sides whit connection.
2m de cable para conexión.	2m cable for connection



REF.
L.AFS25-60

TIRA LED FLEXIBLE 42W

FLEXIBLE LED STRIP

3m	3m
4000K	4000K
Anchura 10mm	Width 10mm
120 Led por metro, 42W cada 3m	120 Led per meter, 42W every 3m.
IP20	IP20
12V	12V
2 lados con conexión	2 sides whit connection.
2m de cable para conexión.	2m cable for connection



REF.
L.AFS27-120

PERFIL ALUMINIO SUPERFICIE 3m + DIFUSOR

3m SURFACE MOUNTED ALUMINIUM PROFILE + MILKY FLAT COVER

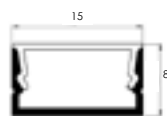

REF.
L.AAP46F

PERFIL ALUMINIO EMBUTIR 3m + DIFUSOR

3m RECESSED MOUNTED ALUMINIUM PROFILE + MILKY FLAT COVER

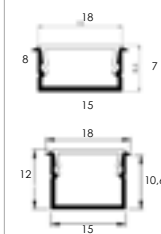

DESCRIP.	REF.
Perfil 7 mm alto / 7 mm height profile	L.AAP44F
Perfil 10,6 mm alto / 10,6 mm height profile	L.AAP45

PERFIL ANGULAR ALUMINIO SUPERFICIE 3m + DIFUSOR

3m SURFACE MOUNTED ANGULAR ALUMINIUM PROFILE + MILKY FLAT COVER

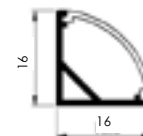

REF.
L.AAP59F

JUEGO TAPAS LATERALES PERFIL SUPERFICIE

END CAP FOR L.AAP46F



REF.
L.AEC46

JUEGO TAPAS LATERALES PERFIL EMBUTIR

END CAP FOR L.AAP44F AND L.AAP45



DESCRIP.	REF.
Perfil 7 mm alto / 7 mm height profile	L.AEC44
Perfil 10,6 mm alto / 10,6 mm height profile	L.AEC45

JUEGO DE TAPAS LATERALES PERFIL ANGULAR A SUPERFICIE

END CAP FOR L.AAP59F



REF.
L.ASM59

SENSOR DE PROXIMIDAD PARA EMBUTIR

RECESSED MOUNTED SENSOR



REF.

L.AID01

SENSOR DE PROXIMIDAD DOBLE PARA EMBUTIR

RECESSED MOUNTED DOUBLE SENSOR



REF.

L.AID05

SENSOR DE PROXIMIDAD TRIPLE PARA EMBUTIR

RECESSED MOUNTED TRIPLE SENSOR



REF.

L.AID08

SENSOR DE PROXIMIDAD DE SUPERFICIE

SURFACE MOUNTED SENSOR



REF.

L.AID02

SENSOR DE PROXIMIDAD DOBLE DE SUPERFICIE

SURFACE MOUNTED DOUBLE SENSOR



REF.

L.AID06

INTERRUPTOR DIMMER DE ALUMINIO PARA EMBUTIR

(Controla la intensidad de la luz)

RECESSED MOUNTED ALUMINIUM DIMMER SWITCH



REF.

L.ATS03

**SENSOR INALÁMBRICO DE PRESENCIA 2.4G,
(CON BATERIA)**

WIRELESS PRESENCE SENSOR SWITCH, 2.4G,
WITH BATTERY

Ø40x13,5mm



REF.

L.APR08

**INTERRUPTOR Y DIMMER (controla intensidad)
INALÁMBRICO, 2.4G, (CON BATERIA)**

TOUCH AND DIMMER SWITCH, 2.4G WIRELESS,
WITH BATTERY

Ø40x13,5mm



REF.

L.ATS14

DISTRIBUIDOR 6 SALIDAS

6un branch box



REF.

L.AL806-6

CABLE PROLONGADOR TIRA LED 2m

2m LED STRIP EXTENSION CABLE



REF.

L.ACC42

CABLE PROLONGADOR SENSOR 2m

2m SENSOR EXTENSION CABLE



REF.

L.ACC27

TRANSFORMADOR 18W, 12V+2m de cable
18W LED TRANSFORMER



REF.
L.ALD41

TRANSFORMADOR 50W, 12V+2m de cable
50W LED TRANSFORMER



REF.
L.ALD42

TRANSFORMADOR 85W, 12V+ 2m de cable
85W LED TRANSFORMER



REF.
L.ALD43

TRANSFORMADOR 60W + DISTRIBUIDOR
60W TRANSFORMER + BRANCH BOX



REF.
L.ALD18

TRANSFORMADOR PARA SENSOR INALÁMBRICO 50W
50W WIRELESS CONTROL LED TRANSFORMER



REF.
L.ALD42.L01

TRANSFORMADOR PARA SENSOR INALÁMBRICO 85W
85W WIRELESS CONTROL LED TRANSFORMER



REF.
L.ALD43.L01

REGLETAS LED

STICKS LED

ADINOR

REGLETA LED STICK SF PARA EMBUTIR 24V

24 V FLUSH MOUNT STICK SF LED + COVER

CRI > 95

100°
Ángulo luz

A++
A+
A

IP 44

UL
Bajo pedido

CE

3
GARANTÍA

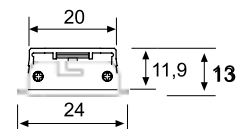

Iluminación casi natural.
Factor cromático CRI > 95.
Durabilidad 30.000 horas.

CRI > 95.
Long life 30,000 hours.

REF.	WATIOS mt	VOLTIOS	LM	LONGITUD / LENGHT	LUZ / LIGHT
L1102078	6,5W	24V	309	330 mm	4000° K BLANCO / WHITE
L2202078	10,8W	24V	496	530 mm	4000° K BLANCO / WHITE
L3302078	17,3W	24V	776	830 mm	4000° K BLANCO / WHITE
L4402078	23,8W	24V	1056	1130 mm	4000° K BLANCO / WHITE

REGLETA LED STICK F SOBREPUESTA CON COLOR AJUSTABLE 24V

24 V SURFACE MOUNT STICK F LED + COVER. WITH ADJUSTABLE COLOUR APPEARANCE

CRI > 82

110°
Ángulo luz

A++
A+
A

IP
20

CE

3
GARANTIA



Factor cromático CRI > 82.
Regleta minimalista extraplana 12 mm. altura.
Durabilidad 30.000 horas.
Color ajustable 2700° K - 5000° k.
Se suministra con cable de 2,5 m. y 2 grapas de fijación.

CRI > 82.
12 mm. height minimal stick.
2,5 m. power cable supply + 2 fixation clips.
Long life 30,000 hours.
Adjustable 2700° K - 5000° K.

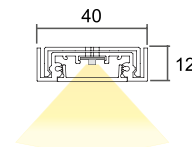

REF.	WATIOS mt	VOLTIOS	LM	LONGITUD / LENGHT	LUZ REGULABLE / ADJUSTABLE LIGHT
L5502078	6,8W	24V	354	450 mm	2700° K - 5000° K
L6602078	9,5W	24V	494	600 mm	2700° K - 5000° K
L0702078	14,4W	24V	749	900 mm	2700° K - 5000° K
L1802078	19,2W	24V	984	1200 mm	2700° K - 5000° K

COMPLEMENTOS COMPLEMENTS

CONTROLADOR REGULADOR TEMPERATURA DE COLOR

DIM CONTROLLER RADIO CONTROLLER

Controlador Radio.
Radio Control.

Controlador WIFI (mediante App*).
Se necesita smartphone o tablet.
WIFI control (*App required).
Smartphone or tablet is needed.

Ambos incluyen controlador 4 salidas.
Debe conectarse entre el transformador y la luz.
4 channel radio telecontrol.
Connection between distributor and luminaire.



REF.	DESCRIPCIÓN / DESCRIPTION
L5071078	RADIO / RADIO CONTROL
L4671078	WIFI

CONTROLADOR INTENSIDAD LUMÍNICA

DIM CONTROLLER RADIO CONTROLLER

Controlador Radio.
Radio Control.

Controlador WIFI (mediante App*).
Se necesita smartphone o tablet.
WIFI control (*App required).
Smartphone or tablet is needed.

Ambos incluyen controlador 4 salidas.
Debe conectarse entre el transformador y la luz.
4 channel radio telecontrol.
Connection between distributor and luminaire.



REF.	DESCRIPCIÓN / DESCRIPTION
L3281078	RADIO / RADIO CONTROL
L4381078	WIFI

TRANSFORMADOR LED

LED TRANSFORMER

Transformador con 12 salidas
Enchufe con cable de 2 m.

12 Ways distributor.
2 m. Power supply cable.



REF.	WATIOS	MEDIDAS / MEASURES
L1371078	15 W	121 x 45 x 17 mm
L2471078	30 W	151 x 41 x 31 mm
L3571078	75 W	185 x 60 x 31 mm



VITRINAS

SHOW CASE



VITRINAS

ADINOR

6m. Condiciones especiales de envío
6m. Special shipping conditions

20x45 P4

PERFIL 20x45 P4
20x45 P4 PROFILE

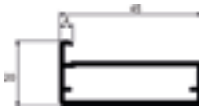
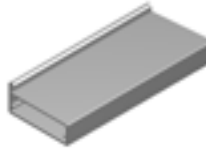

20x45 P8

PERFIL 20x45 P8
20x45 P8 PROFILE

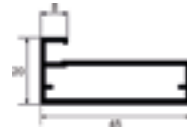
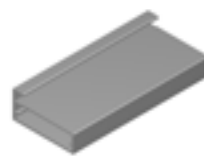

35x45 P8

PERFIL 35x45 P8
35x48 P8 PROFILE

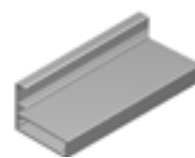

ACABADOS	FINISHINGS	Longitud / Length : 6 m.	Longitud / Length : 6 m.	Longitud / Length : 6 m.
LACADOS	COATED	REF.	REF.	REF.
Blanco	White	7994.L.B	7991.L.B	7995.L.B
Negro Mate	Mat Black	7994.L.NM	7991.L.NM	7995.L.NM
ANODIZADOS	ANODIZED	REF.	REF.	REF.
Plata Brillo	Polished Silver	7994.A.P	7991.A.P	7995.A.P
Plata Mate	Natural Anodized	7994.A.PM	7991.A.PM	7995.A.PM
Plata Brillo Químico	High Gloss Silver	7994.A.BQ	7991.A.BQ	-

20x45 P20

PERFIL 20x45 P20
20x45 P20 PROFILE

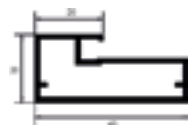
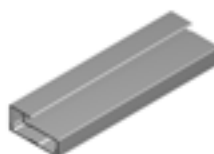

20x45 P4N

PERFIL 20x45 P4N
20x45 P4N PROFILE

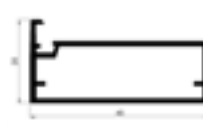

35x45 P4

PERFIL 35x45 P4
35x45 P4 PROFILE

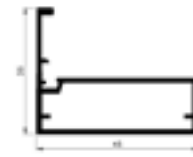
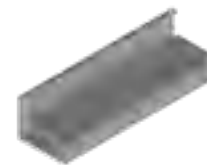

ACABADOS	FINISHINGS	Longitud / Length : 6 m.	Longitud / Length : 6 m.	Longitud / Length : 6 m.
LACADOS	COATED	REF.	REF.	REF.
Blanco	White	7990.L.B	-	-
Negro Mate	Mat Black	7990.L.NM	7889.L.NM	7888.L.NM
ANODIZADOS	ANODIZED	REF.	REF.	REF.
Plata Brillo	Polished Silver	7990.A.P	-	-
Plata Mate	Natural Anodized	7990.A.PM	7889.A.PM	7888.A.PM
Plata Brillo Químico	High Gloss Silver	-	-	-

20x45 P45

PERFIL 20x45 P45
20x45 P45 PROFILE



20x56 C/P

PERFIL 20x56 C/P
20x56 C/P PROFILE

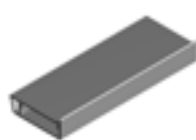

16x60

PERFIL 16x60
16x60 PROFILE



16x60 T

PERFIL TIRADOR 16x60
16x60 HANDLE PROFILE

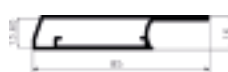

19x21

PERFIL 19x21
19x21 PROFILE

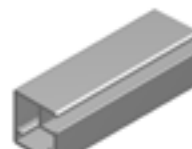

20x18 P8

PERFIL 21x18 P8
21x18 P8 PROFILE

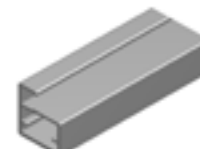

Longitud / Lenght : 6 m.

Longitud / Lenght : 6 m.

Longitud / Lenght : 6 m.

Longitud / Lenght : 6 m.

Longitud / Lenght : 6 m.

Longitud / Lenght : 6 m.

REF.

REF.

REF.

REF.

REF.

REF.

7998.L.B

79916.L.B

7999.L.B

79918.L.B

7993.L.B

7996.L.B

7998.L.NM

79916.L.NM

7999.L.NM

79918.L.NM

7993.L.NM

7996.L.NM

REF.

REF.

REF.

REF.

REF.

REF.

7998.A.P

79916.A.P

7999.A.P

79918.A.P

7993.A.P

7996.A.P

7998.A.PM

79916.A.PM

7999.A.PM

79918.A.PM

7993.A.PM

7996.A.PM

TIRADOR 37x16

TIRADOR 37x16
37x16 HANDLE PROFILE

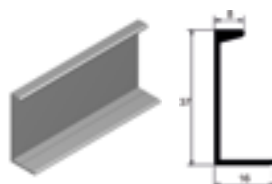

126x35

TIRADOR 126x35
126x35 HANDLE PROFILE



ACABADOS

FINISHINGS

Longitud / Lenght : 5 m.

Longitud / Lenght : 150 mm.

Longitud / Lenght : 126 mm.

LACADOS

COATED

REF.

REF.

REF.

Blanco

White

7997.L.B

7997.L.B.150

79971.L.B

Negro Mate

Mat Black

7997.L.NM

7997.L.NM.150

79971.L.NM

ANODIZADOS

ANODIZED

REF.

REF.

REF.

Plata Brillo

Polished Silver

7997.A.P

7997.A.P.150

79971.A.P

Plata Mate

Natural Anodized

7997.A.PM

7997.A.PM.150

79971.A.PM

Plata Brillo Químico

High Gloss Silver

7997.A.BQ

7997.A.BQ.150

79971.A.BQ

CONJUNTO 4 ESCUADRAS DE ZAMAK [+8 TORNILLOS]

4 ZAMAK INNER CONNECTION ANGLE + 8 SCREWS



REF.
7932

CONJUNTO 4 ESCUADRAS 34x34 DE ACERO [+8 TORNILLOS]

4 34x34 INNER CONNECTION ANGLE + 8 SCREWS



REF.
7933

U DE PVC PARA CRISTAL DE 4mm.

PVC U FOR 4mm, GLASS



REF.
7952

PERFIL / PROFILE
20x45 P4

U DE PVC PARA CRISTAL DE 4mm

PVC U FOR 4mm, GLASS



REF.
7951

PERFIL / PROFILE
20x45 P8, 35x45 P8, 20x45 P20,
20x45 P45, 20x18 P8

U DE PVC PARA CRISTAL DE 4mm

PVC GASKET FOR 4mm, GLASS



REF.
7953

PERFIL / PROFILE
20x45 P4N

BISAGRA SALICE RECTA/ACODADA/ SUPERACODADA

105° SALICE HINGE / HALF OVERLAY HINGE / INSET MOUNTING HINGE



REF.
HS11
HS21
HS31

PERFIL / PROFILE
20x18 P8, 19x21

BASE SALICE CON REGULACIÓN

SALICE CLIP PLATE



REF.
HS42 H = 0
HS41 H = 3

PERFIL / PROFILE
20x18 P8, 19x21

BASE CON REGULACIÓN PARA TABLERO 16mm.

CLIP PLATE FOR 16mm. BOARD



REF.
H55.PL.16

BISAGRA RECTA/ACODADA/SUPERACODADA CON SOFT CLOSING

110° / HALF OVERLAY / INSET MOUNTING SOFT CLOSING HINGE



REF.
H15.PL.R
H25.PL.A
H35.PL.SA

BISAGRA RECTA/ACODADA/SUPERACODADA CON SOFT CLOSING

165° / HALF OVERLAY / INSET MOUNTING SOFT CLOSING HINGE



REF.
H45.PL.165R
H45.PL.165A
H45.PL.165SA

BASE CON REGULACIÓN PARA TABLERO 19mm.

CLIP PLATE FOR 19mm. BOARD



REF.
H55.PL.19

H = 0

HOJA DE PEDIDO DE VITRINAS DE ALUMINIO

Fecha: _____ N° Pedido: _____

Cliente: _____

REF: 7991	REF: 7994
Acabados	Acabados
Plata Mate <input type="checkbox"/>	Plata Mate <input type="checkbox"/>
Plata Brillo <input type="checkbox"/>	Plata Brillo <input type="checkbox"/>
Lacado Blanco <input type="checkbox"/>	Lacado Blanco <input type="checkbox"/>
Lacado Negro <input type="checkbox"/>	Lacado Negro <input type="checkbox"/>

REF: 7995	REF: 7998	REF: 7990	REF: 7996	REF: 7993	REF: 79916	REF: 7999	REF: 79918
Acabados	Acabados	Acabados	Acabados	Acabados	Acabados	Acabados	Acabados
Plata Mate <input type="checkbox"/>	Plata Mate <input type="checkbox"/>	Plata Mate <input type="checkbox"/>	Plata Mate <input type="checkbox"/>	Plata Mate <input type="checkbox"/>	Plata Mate <input type="checkbox"/>	Plata Mate <input type="checkbox"/>	Plata Mate <input type="checkbox"/>
Plata Brillo <input type="checkbox"/>	Plata Brillo <input type="checkbox"/>	Plata Brillo <input type="checkbox"/>	Plata Brillo <input type="checkbox"/>	Plata Brillo <input type="checkbox"/>	Plata Brillo <input type="checkbox"/>	Plata Brillo <input type="checkbox"/>	Plata Brillo <input type="checkbox"/>
Lacado Blanco <input type="checkbox"/>	Lacado Blanco <input type="checkbox"/>	Lacado Blanco <input type="checkbox"/>	Lacado Blanco <input type="checkbox"/>	Lacado Blanco <input type="checkbox"/>	Lacado Blanco <input type="checkbox"/>	Lacado Blanco <input type="checkbox"/>	Lacado Blanco <input type="checkbox"/>
Lacado Negro <input type="checkbox"/>	Lacado Negro <input type="checkbox"/>	Lacado Negro <input type="checkbox"/>	Lacado Negro <input type="checkbox"/>	Lacado Negro <input type="checkbox"/>	Lacado Negro <input type="checkbox"/>	Lacado Negro <input type="checkbox"/>	Lacado Negro <input type="checkbox"/>

EL MODELO REF. 7995 SE PUEDE COMBINAR CON LA REF. 7991 Y EL MODELO REF. 79918 CON EL MODELO REF. 7999

Cantidad	Altura (Y)	Anchura (X)
Comentarios		

*De la medida dada se descontarán 2mm. en altura y 2mm. en anchura.
*Medidas siempre en mm.

Mecanización para Bisagra	N° de Bisagras <input type="text"/>	Distancia (B) <input type="text"/>	<small>* Por defecto B = 100mm. * Para 3 o más bisagras el mecanizado será equidistante entre ellas.</small>
Colocación de los Mecanización de las Bisagras según vista Trasera (A)	Izquierda <input type="checkbox"/>	Arriba <input type="checkbox"/>	
	Derecha <input type="checkbox"/>	Abajo <input type="checkbox"/>	
Modelo Tirador Vitrina	Ninguno <input type="checkbox"/>	Para Atornillar (150mm.) <input type="checkbox"/>	
	Embutido <input type="checkbox"/>	Para Atornillar (1200mm.) <input type="checkbox"/>	

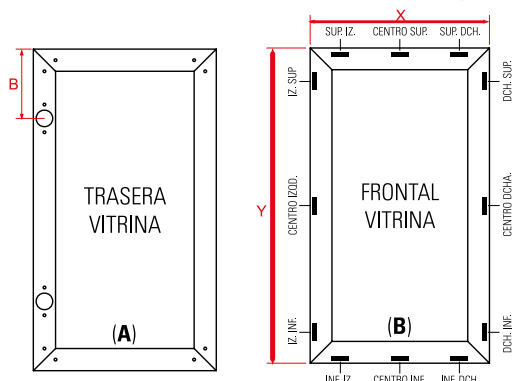

Mecanización Tirador Embutido según vista Frontal (B)

PERFIL SUPERIOR	PERFIL INFERIOR
SUPERIOR IZQUIERDA <input type="checkbox"/>	INFERIOR IZQUIERDA <input type="checkbox"/>
CENTRO SUPERIOR <input type="checkbox"/>	CENTRO INFERIOR <input type="checkbox"/>
SUPERIOR DERECHA <input type="checkbox"/>	INFERIOR DERECHA <input type="checkbox"/>
PERFIL DERECHO	PERFIL IZQUIERDO
DERECHA SUPERIOR <input type="checkbox"/>	IZQUIERDA SUPERIOR <input type="checkbox"/>
CENTRO DERECHA <input type="checkbox"/>	CENTRO IZQUIERDA <input type="checkbox"/>
DERECHA INFERIOR <input type="checkbox"/>	IZQUIERDA INFERIOR <input type="checkbox"/>



HERRAJES CABINA SANITARIA

CUBICLE PARTITION HARDWARE



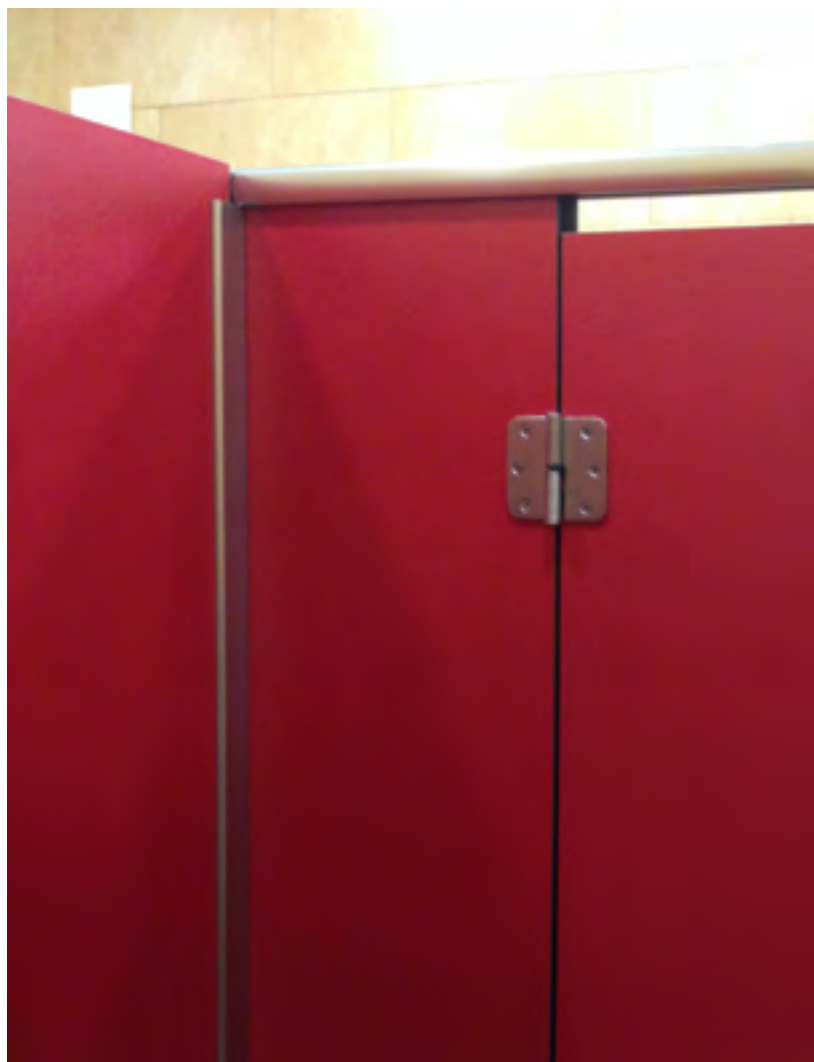



6m. Condiciones especiales de envío
6m. Special shipping conditions

PERFIL PANEL ALUMINIO 13mm.

13mm. BOARD ALUMINIUM PROFILE

Longitud / Length : 6 m.

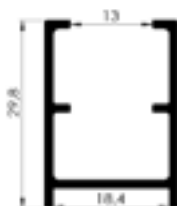

REF.	Anodizado	Anodized
SCA-PN13.A.PM	Plata Mate	Natural Anodized
SCA-PN13.A.X	Inox	Inox

ALUMINIO ANODIZADO / ANODIZED ALUMINIUM

PERFIL ESQUINA PANEL ALUMINIO 13mm

90° JOING ALUMINIUM PROFILE

Longitud / Length : 6 m.

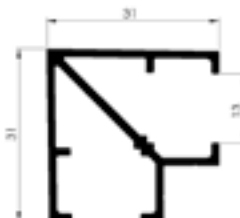

REF.	Anodizado	Anodized
SCA-PE13.A.PM	Plata Mate	Natural Anodized
SCA-PE13.A.X	Inox	Inox

ALUMINIO ANODIZADO / ANODIZED ALUMINIUM

PERFIL ALUMINIO REMATE PUERTA 13mm.

13mm. DOOR ALUMINIUM PROFILE

Longitud / Length : 6 m.

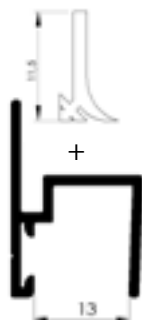

REF.	Anodizado	Anodized
SCA-PP13.A.PM	Plata Mate	Natural Anodized
SCA-PP13.A.X	Inox	Inox

ALUMINIO ANODIZADO / ANODIZED ALUMINIUM

PERFIL SUPERIOR ALUMINIO 13mm.

SUPERIOR ALUMINIUM PROFILE

Longitud / Length : 6 m.

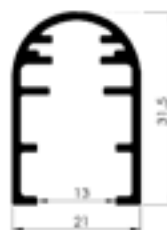

REF.	Anodizado	Anodized
SCA-PR13.A.PM	Plata Mate	Natural Anodized
SCA-PR13.A.X	Inox	Inox

ALUMINIO ANODIZADO / ANODIZED ALUMINIUM

PERFIL ANGULAR ALUMINIO

OUTER & INNER ALUMINIUM CONNECTION
 ANGLE PROFILE

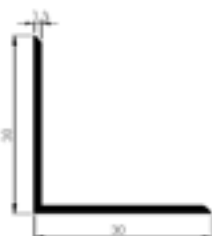

REF.	Anodizado	Anodized
SCA-PAA	30x30x1,3mm. Ext.2 m.	1

ALUMINIO ANODIZADO / ANODIZED ALUMINIUM

ESCUADRA UNION MONTAJE A INGLETE

INTERNAL INNER CONNECTION ANGLE FOR MITTRE CUT MOUNTING



REF.	Anodizado	Anodized
ME700	1	

ACERO GALVANIZADO / ZINC PLATED STEEL

TUBO DIÁMETRO 25

25mm Ø INOX PIPE

Longitud / Length : 2 m.



REF.	Anodizado	Anodized
SCA-TR25	1	

INOX /SS304

EMPALME BARRA INTERNO

INTERNAL PIPE JOINT

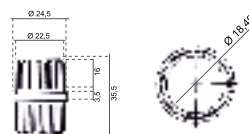

REF.	Anodizado	Anodized
SCA-ET	1	

INOX /SS304

SOPORTE TUBO PARED

WALL FIXING PLATE

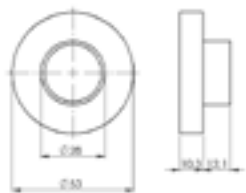

REF.	
SCA-SPT	10

INOX /SS304

SOPORTE SUPERIOR PANEL / TUBO

PIPE - BOARD CLAMP

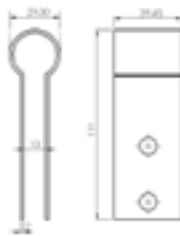

REF.	
SCA-SSPT	5

INOX /SS304

BISAGRAS

HINGES

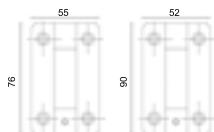

REF.		
SCA-BCM	Con muelle \ With Spring	10
SCA-BSM	Sin muelle \ Without Spring	10
SCA-BSMEC	Sin muelle \ Without Spring ECO	10

INOX /SS304

PIE SUELO REGULABLE

ADJUSTABLE FEET



REF.		
SCA-PP316	11 - 18 cm INOX / SS316	5
SCA-PP	11 - 18cm.	5
SCA-PPG	21 - 38cm.	5
SCA-RP1	Adaptador pie 1mm. \ 1mm gasket	20

INOX /SS304

CONDENA - PESTILLO

LOCK

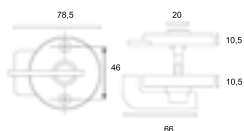

REF.	
SCA-PI	5

INOX /SS304

CONDENA - PESTILLO CON VARILLA

LOCK



REF.	
SCA-CV	5

INOX /SS304

PERCHA

HANGER

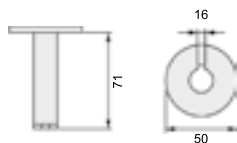

REF.	
SCA-PCG	20

INOX /SS304

JUEGO POMO TIRADOR 25mm.

25mm. Ø OUTER & INNER HANDLE

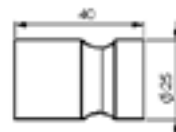

REF.	
SCA-JT25	10

INOX /SS304

NUDO CONECTOR 2 TUBOS 90°

90° JOINT (TWO PIPES)



REF.	
SCA-CT90	10

INOX /SS304

NUDO CONECTOR 3 TUBOS 90°-180°

180° JOINT (THREE PIPES)



REF.	
SCA-CTT	10

INOX /SS304

6m. Condiciones especiales de envío
6m. Special shipping conditions

ESCUADRA FIJACIÓN PARED
 CONNECTION ANGLE

REF. **SCA-E** 20

INOX /SS304

SOPORTE U FIJACIÓN PARED
 WALL FIXING BRACKET

REF. **SCA-SUP** U 50mm. 1

INOX /SS304

SOPORTE PARED LATERAL
 LATERAL BOARD JOINT

REF. **SCA-SFP** 1

INOX /SS304

SOPORTE PARED CENTRAL
 CENTRAL BOARD JOINT

REF. **SCA-SIP** 1

INOX /SS304

SOPORTE U FIJACIÓN PARED
 WALL FIXING BRACKET

REF. **SCA-PUP** U 180mm. 1

INOX /SS304

PERFIL ANGULAR ACERO INOXIDABLE
 OUTER & INNER INOX CONNECTION ANGLE PROFILE

REF. **SCA-PAE** 33x33x1,2mm. Ext.1,8 m. 1

INOX /SS304

TORNILLO ROSCACHAPA INOX
 THREAD TAPPING SCREW

REF. **SCA-TRCH** 100

TORNILLO / SCREW
 3,7x10

INOX /SS304

TORNILLOS PASANTE INOX
 THROUGH BOLT

REF. **SCA-TP** 100

TORNILLO / SCREW
 5x11-14

INOX /SS304

JUEGO HERRAJES PUERTA CORREDERA - ACERO INOX
 SLIDING DOORS FITTINGS - INOX

REF. **SCA-JHC** 5

INOX /SS304

JUEGO HERRAJES PUERTA CORREDERA - ALUMINIO
 SLIDING DOORS FITTINGS - ALUMINIUM

REF. **SCA-JHA** 1

INOX /SS304
ALUMINIO ANODIZADO / ALUMINIUM ANODIZED

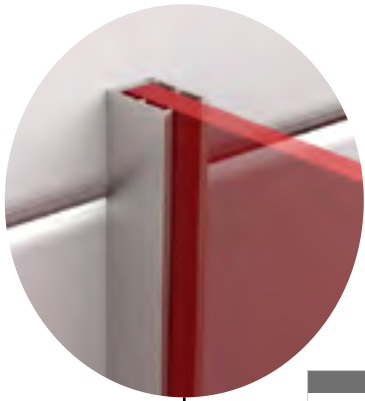

REF.
SCA-PR13.A.PM
SCA-PR13.A.X

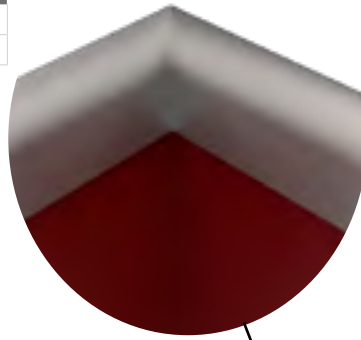

REF.
ME700

REF.
SCA-PN13.A.PM
SCA-PN13.A.X

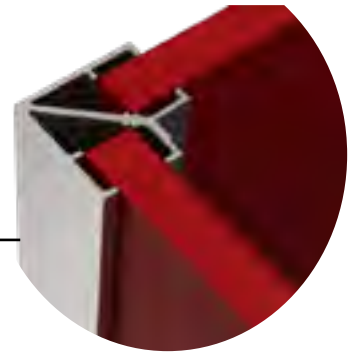

REF.
SCA-PE13.A.PM
SCA-PE13.A.X

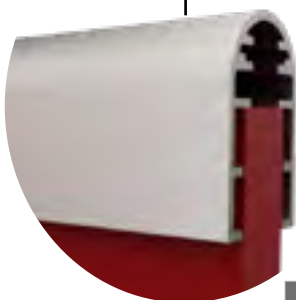

REF.
SCA-PR13.A.PM
SCA-PR13.A.X

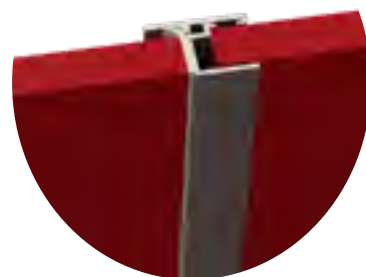

REF.
SCA-PP13.A.PM
SCA-PP13.A.X



REF.
SCA-SIP



REF.
SCA-SUP

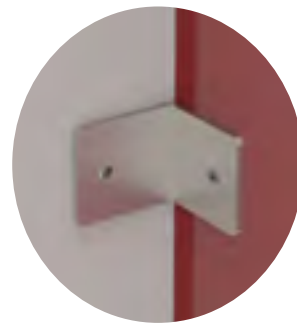

REF.
SCA-E

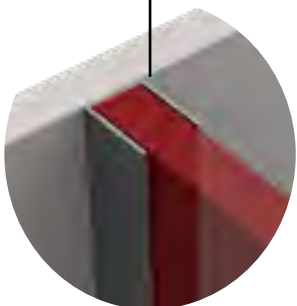

REF.
SCA-PUP

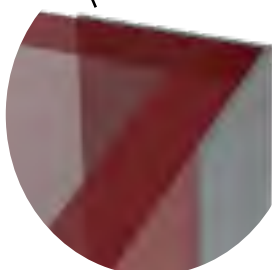

REF.
SCA-PAE



REF.
SCA-SFP

CABINAS SANITARIAS A MEDIDA

CUSTOM CUBICLE PARTITION

Posibilidad de suministrar las cabinas totalmente acabadas y preparadas para su instalación incluyendo todos los accesorios necesarios.

La fabricación se realiza con laminado compacto fenólico de un espesor de 12mm con dos caras decorativas y un núcleo negro.

Todas las piezas fenólicas irán con los cantos mecanizados y redondeados, así como los orificios y pretaladros para una mayor facilidad de montaje.

Para el herraje disponemos de perfiles de aluminio, acero inoxidable ó mixto. Todo el herraje de acero inoxidable es calidad AISI304, pudiéndose solicitar AISI316.

Gama de acabados fenólicos:

We can supply fully finished cubicle partition, ready to install including all necessary hardware.

Cubicle partition made by phenolic compact laminate, 12mm thickness with two decorative faces and black core.

All phenolic boards come with mechanized and rounded edges as well as holes and knockouts made for greater flexibility and easy installation.

We have several options for hardware: aluminum, stainless steel or mixed All stainless-steel hardware is AISI304 quality, also AISI316 can be requested.

Range of phenolic finishes:

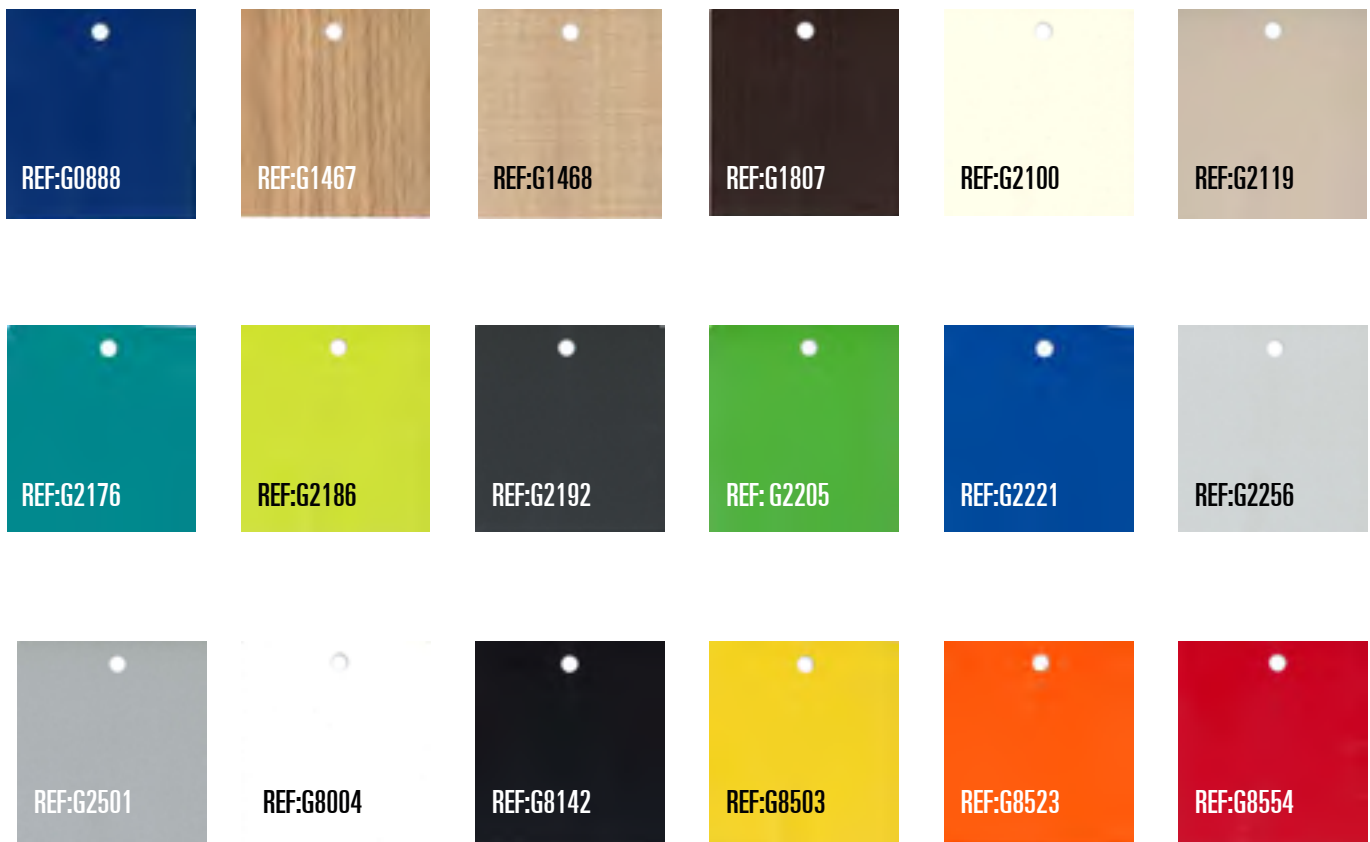

INSTALACIÓN COMERCIAL

COMMERCIAL FURNISHINGS

PH

226

S30

227

S20

235

DOLCE & GABBANA

PH100

ADINOR

6m. Condiciones especiales de envío
6m. Special shipping conditions

PERFIL BÁSICO PANELADO HORIZONTAL

HORIZONTAL PROFILE



REF.
PH100.A.C

Longitud / Length : **6,05 m.**

FRESA PERFIL BÁSICO

HORIZONTAL PROFILE DRILL

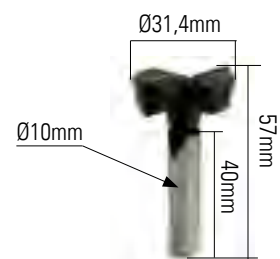

REF.
PH110

GANCHO LAMA 10-20-30cm.

10-20-30cm. HANGER



REF.	ACABADOS / FINISHINGS
PH213CR 20cm.	Cromo / Nickel Plated
PH214CR 30cm.	Cromo / Nickel Plated

REF.	ACABADOS / FINISHINGS
PH212N 10cm.	Negro / Black
PH213N 20cm.	Negro / Black
PH214N 30cm.	Negro / Black

COLGADOR INCLINADO 40cm.

40cm. HANGER 30°



REF.	ACABADOS / FINISHINGS
PH231CR	Cromo / Nickel Plated
PH231N	Negro / Black

GANCHO LAMA CON PORTAPRECIO 10-20-30cm.

10-20-30cm. HANGER WITH PRICE TAG



REF.	ACABADOS / FINISHINGS
PH253CR 20cm.	Cromo / Nickel Plated
PH254CR 30cm.	Cromo / Nickel Plated

REF.	ACABADOS / FINISHINGS
PH253N 20cm.	Negro / Black
PH254N 30cm.	Negro / Black

COLGADOR FLAUTA 40cm.

40cm. HANGER

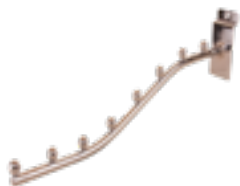

REF.	ACABADOS / FINISHINGS
PH230CR	Cromo / Nickel Plated

SOPORTE CARTELA 30cm. DER. + IZO.

30cm. PANEL CLAMP



REF.	ACABADOS / FINISHINGS
PH220CR	Cromo / Nickel Plated

SOPORTE ESTANTE 30cm. DER. + IZO.

30cm. PANEL CLAMP



REF.	ACABADOS / FINISHINGS
PH222CR	Cromo / Nickel Plated
PH222N	Negro / Black

ZAPATILLERO METÁLICO

SHOE HANGER



REF.	ACABADOS / FINISHINGS
PH223N	Negro / Black

SOPORTE BALONES

BALL HOLDER



REF.	ACABADOS / FINISHINGS
PH211CR	Cromo / Nickel Plated

SOPORTE CASCO

HELMET HANGER



REF.	ACABADOS / FINISHINGS
PH243CR	Cromo / Nickel Plated

S30

ADINOR

MC-30

PERFIL MC-30
MC-30 PROFILE



MC-30 ALA

PERFIL MC-30 ALA
MC-30 FLANGE PROFILE



E-30

PERFIL E-30
E-30 PROFILE

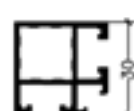

R-1

PERFIL R-1
R-1 PROFILE



ACABADOS	FINISHINGS	Longitud / Lenght : 6 m.	Longitud / Lenght : 6 m.	Longitud / Lenght : 6 m.	Longitud / Lenght : 6 m.
LACADOS	COATED	REF.	REF.	REF.	REF.
Blanco	White	251.L.B	251A.L.B	255.L.B	211.L.B
ANODIZADOS	ANODIZED	REF.	REF.	REF.	REF.
Plata Brillo	Polished Silver	251.A.P	251A.A.P	255.A.P	211.A.P
Plata Mate	Natural Anodized	251.A.PM	251A.A.PM	255.A.PM	211.A.PM
SIN ANODIZAR	NO ANODIZED	REF.	REF.	REF.	REF.
Crudo	Raw	251.A.C	251A.A.C	255.A.C	211.A.C

R-1 ALA

PERFIL R-1 ALA
R-1 FLANGE PROFILE

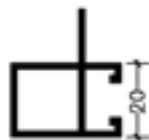

R-1 P

PERFIL R-1 P
R-1P PROFILE

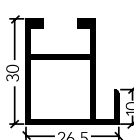
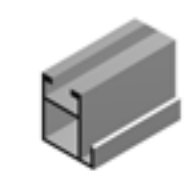

R-2

PERFIL R-2
R-2 PROFILE



R-2 ALA

PERFIL R-2 ALA
R-2 FLANGE PROFILE

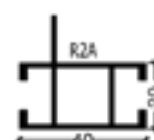

ACABADOS	FINISHINGS	Longitud / Lenght : 6 m.	Longitud / Lenght : 6 m.	Longitud / Lenght : 6 m.	Longitud / Lenght : 6 m.
LACADOS	COATED	REF.	REF.	REF.	REF.
Blanco	White	211A.L.B	211PL.B	222.L.B	222A.L.B
ANODIZADOS	ANODIZED	REF.	REF.	REF.	REF.
Plata Brillo	Polished Silver	211A.A.P	211PA.P	222.A.P	222A.A.P
Plata Mate	Natural Anodized	211A.A.PM	211PA.PM	222.A.PM	222A.A.PM
SIN ANODIZAR	NO ANODIZED	REF.	REF.	REF.	REF.
Crudo	Raw	211A.A.C	211PA.C	222.A.C	222A.A.C

S30

ADINOR

R-3
PERFIL R-3
R-3 PROFILE



R-3 P
PERFIL R-3 P
R-3 P PROFILE

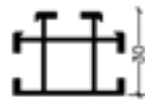

Z-50
PERFIL Z-50
Z-50 PROFILE

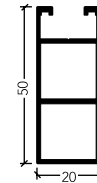

Z-80
PERFIL Z-80
Z-80 PROFILE

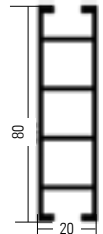

6m. Condiciones especiales de envío
6m. Special shipping conditions

ACABADOS	FINISHINGS	Longitud / Lenght : 6 m.	Longitud / Lenght : 6 m.	Longitud / Lenght : 6 m.	Longitud / Lenght : 6 m.
LACADOS	COATED	REF.	REF.	REF.	REF.
Blanco	White	233.L.B	235.L.B	-	228.L.B
ANODIZADOS	ANODIZED	REF.	REF.	REF.	REF.
Plata Brillo	Polished Silver	233.A.P	235.A.P	-	228.A.P
Plata Mate	Natural Anodized	233.A.PM	235.A.PM	-	228.A.PM
SIN ANODIZAR	NO ANODIZED	REF.	REF.	REF.	REF.
Crudo	Raw	233.A.C	235.A.C	2285.A.C	228.A.C

OC-8
PERFIL OC-8
OC-8 PROFILE

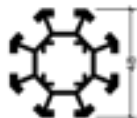

MCO-30
PERFIL MCO-30
MCO-30 PROFILE



R-4
PERFIL R-4
R-4 PROFILE

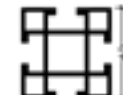

MC-40
PERFIL MC-40
MC-40 PROFILE



ACABADOS	FINISHINGS	Longitud / Lenght : 6 m.	Longitud / Lenght : 6 m.	Longitud / Lenght : 6 m.	Longitud / Lenght : 6 m.
LACADOS	COATED	REF.	REF.	REF.	REF.
Blanco	White	288.L.B	252.L.B	244.L.B	261.L.B
ANODIZADOS	ANODIZED	REF.	REF.	REF.	REF.
Plata Brillo	Polished Silver	288.A.P	252.A.P	244.A.P	261.A.P
Plata Mate	Natural Anodized	288.A.PM	252.A.PM	244.A.PM	261.A.PM
SIN ANODIZAR	NO ANODIZED	REF.	REF.	REF.	REF.
Crudo	Raw	288.A.C	252.A.C	244.A.C	261.A.C

Z-71

PERFIL Z-71
Z-71 PROFILE

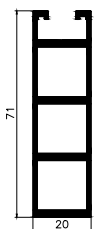

Z-72

PERFIL Z-72
Z-72 PROFILE



O-1

PERFIL O-1
O-1 PROFILE



A-105

PERFIL A-105
A-105 PROFILE



A-135

PERFIL A-135
A-135 PROFILE



T-30

PERFIL T-30
T-30 PROFILE

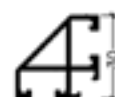

Longitud / Lenght : **6 m.**

REF.

-

REF.

-

-

REF.

2286.A.C

Longitud / Lenght : **5,4m.**

REF.

-

REF.

-

-

REF.

2289.A.C

Longitud / Lenght : **6 m.**

REF.

201.L.B

REF.

201.A.P

201.A.PM

REF.

201.A.C

Longitud / Lenght : **6 m.**

REF.

256.L.B

REF.

256.A.P

256.A.PM

REF.

256.A.C

Longitud / Lenght : **6 m.**

REF.

221.L.B

REF.

221.A.P

221.A.PM

REF.

221.A.C

Longitud / Lenght : **6 m.**

REF.

254.L.B

REF.

254.A.P

254.A.PM

REF.

254.A.C

CM-30

PERFIL CM-30
CM-30 PROFILE



CC-11

PERFIL CC-11
CC-11 PROFILE



CR-20

PERFIL CR-20
CR-20 PROFILE

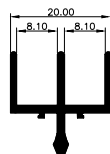

CR-M

PERFIL CR-M
CR-M PROFILE

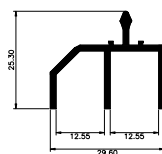

CR-L

PERFIL CR-L
CR-L PROFILE

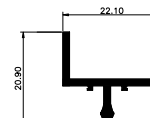

CR-I

PERFIL CR-I
CR-I PROFILE

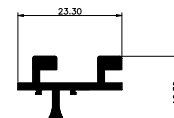

Longitud / Lenght : **6 m.**

REF.

253.L.B

REF.

253.A.P

253.A.PM

REF.

253.A.C

Longitud / Lenght : **6 m.**

REF.

272.L.B

REF.

272.A.P

272.A.PM

REF.

272.A.C

Longitud / Lenght : **6 m.**

REF.

273.L.B

REF.

273.A.P

273.A.PM

REF.

273.A.C

Longitud / Lenght : **6 m.**

REF.

274.L.B

REF.

274.A.P

274.A.PM

REF.

274.A.C

Longitud / Lenght : **6 m.**

REF.

275.L.B

REF.

275.A.P

275.A.PM

REF.

275.A.C

Longitud / Lenght : **6 m.**

REF.

276.L.B

REF.

276.A.P

276.A.PM

REF.

276.A.C

S30

ADINOR

TC-20

PERFIL TC-20
TC-20 PROFILE



CR-24

PERFIL CR-24
CR-24 PROFILE



TAPACANAL

TAPACANAL
GROOVE COVER PROFILE



PANELADO

PERFIL PANELADO TECHO
SHELF SUPPORT PROFILE



6m. Condiciones especiales de envío

6m. Special shipping conditions

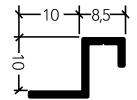
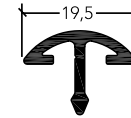

ACABADOS	FINISHINGS	Longitud / Length : 6 m.	Longitud / Length : 6 m.	Longitud / Length : 6 m.	Longitud / Length : 6 m.
LACADOS	COATED	REF.	REF.	REF.	REF.
Blanco	White	291.L.B	271.L.B	3441.L.B	3758.L.B
ANODIZADOS	ANODIZED	REF.	REF.	REF.	REF.
Plata Brillo	Polished Silver	291.A.P	271.A.P	3441.A.P	3758.A.P
Plata Mate	Natural Anodized	291.A.PM	271.A.PM	3441.A.PM	3758.A.PM
SIN ANODIZAR	NO ANODIZED	REF.	REF.	REF.	REF.
Crudo	Raw	291.A.C	271.A.C	3441.A.C	3758.A.C
Latón	Brass	-	-	-	-

E-30H

NUDO E-30 HUECO ZAMAK
E-30H ZAMAK TRIPLE
CONNECTION ANGLE



T-30 LATÓN

NUDO T-30 LATÓN
T-30 BRASS TRIPLE
CONNECTION ANGLE



MC-40 ZAMAK

NUDO MC-40 ZAMAK
MC-40 ZAMAK TRIPLE
CONNECTION ANGLE



A-105 ZAMAK

NUDO A-105 ZAMAK
A-105 ZAMAK TRIPLE
CONNECTION ANGLE



ACABADOS	FINISHINGS	REF.	REF.	REF.	REF.
LACADOS	COATED	REF.	REF.	REF.	REF.
Blanco	White	3555B	3541B	3613B	3563B
ANODIZADOS	ANODIZED	REF.	REF.	REF.	REF.
Plata Brillo	Polished Silver	3555P	3541P	3613P	3563P
Plata Mate	Natural Anodized	3555PM	3541PM	3613PM	3563PM
SIN ANODIZAR	NO ANODIZED	REF.	REF.	REF.	REF.
Crudo	Raw	3555SP	3541SP	3613SP	3563SP
Latón	Brass	-	3541	-	-

MC-30 ZAMAK

NUDO MC-30 ZAMAK
MC-30 ZAMAK TRIPLE
CONNECTION ANGLE



MC-30 ABS

NUDO MC-30 ABS
MC-30 ABS TRIPLE
CONNECTION ANGLE



MC-30H

NUDO HUECO MC-30H ZAMAK
MC-30 H ZAMAK TRIPLE
CONNECTION ANGLE



MC-30 LATÓN

NUDO MC 30 LATÓN
MC-30 BRASS TRIPLE
CONNECTION ANGLE



E-30 ABS

NUDO E-30 ABS
E-30 ABS TRIPLE
CONNECTION ANGLE



E-30 LATÓN

NUDO E-30 LATÓN
E-30 BRASS TRIPLE
CONNECTION ANGLE



REF.	REF.	REF.	REF.	REF.	REF.
3513B	3514B	3503B	3511B	3554B	3551B
REF.	REF.	REF.	REF.	REF.	REF.
3513P	3514P	3503P	3511P	3554P	3551P
3513PM	3514PM	3503PM	3511PM	3554PM	3551PM
REF.	REF.	REF.	REF.	REF.	REF.
3513SP	3514SP	3503SP	3511SP	3554SP	3551SP
-	-	-	3511	-	3551

ANGULAR

ANGULAR 19x40mm
19x40mm ANGLE PROFILE

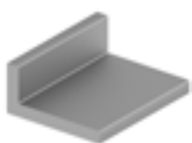

MCO-30 ZAMAK

NUDO MCO-30 ZAMAK
MCO-30 ZAMAK TRIPLE
CONNECTION ANGLE



CM-30 ZAMAK

NUDO CM-30 ZAMAK
CM-30 ZAMAK TRIPLE
CONNECTION ANGLE



CM-30 ABS

NUDO CM-30 ABD
CM-30 ABS TRIPLE
CONNECTION ANGLE



REF.	REF.	REF.	REF.
-	3523B	3533B	3534B
REF.	REF.	REF.	REF.
-	3523P	3533P	3534P
-	3523PM	3533PM	3534PM
REF.	REF.	REF.	REF.
2288.A.C	3523SP	3533SP	3534SP
-	-	-	-

S30

ADINOR

GRAPA UNIÓN ALUMINIO

PIN CONECTOR



REF.
3761

TENSOR UNIÓN 5 PIEZAS

PERPENDICULAR & PARALLEL JOINT



REF.
3711

PLANTILLA TENSOR / GRAPA

DRILLING JIG FOR JOINTS



REF.
3891

CORREDERA SUPERIOR PVC

UPPER SLIDING DOOR PROFILE



REF.	Acabados	Finishings
3421N	Negro	Black
3421G	Gris	Grey

CORREDERA INFERIOR PVC

LOWER SLIDING DOOR PROFILE



REF.	Acabados	Finishings
3422N	Negro	Black
3422G	Gris	Grey

TAPACANAL PVC

GROOVE COVER PROFILE



REF.	Acabados	Finishings
3441B	Blanco	White
3441N	Negro	Black
3441O	Oro	Gold
3441P	Plata Brillo	Polished Silver
3441R	Rojo	Red

TIRASOPORTE CRISTAL PVC

SHELF SUPPORT PROFILE



REF.
3411

JUEGO GOMA ACRISTALAR PVC

PVC GASKET



REF.
3461

JUEGO JUNQUILLO RÍGIDO ACRISTALAR

CLAMPING PROFILE SET



REF.
3431

GOMA ACRISTALAR 4mm.

4mm. GASKET



REF.
3424

GOMA ACRISTALAR 5mm.

5mm. GASKET



REF.
3425

GOMA ACRISTALAR 6mm.

6mm. GASKET



REF.
3426

PERFIL ADHESIVO ANTIVIBRACIÓN 6mm.

6mm. SELF-ADHESIVE SLOT REDUCER PROFILE



REF.
3427

CLIP FIJACIÓN CORREDERA

CLIP CONNECTION



REF.
375

Para perfil **CR-20, CR-M, CR-L, CR-I**
For **CR-20, CR-M, CR-L, CR-I** profile

ESCUADRA PLANA NYLON

NYLON FLAT INTERIOR BRACKET 90°



REF.
3782

ESCUADRA VERTICAL NYLON

NYLON VERTICAL INTERIOR BRACKET 90°



REF.
3781

ESCUADRA CUADRANGULAR NYLON

NYLON INTERIOR BRACKET 90°



REF.
3785

ESCUADRA INGLETE CC11 NYLON

NYLON MITRE CUT INTERIOR BRACKET



REF.
3783

COJINETE CC11

CC11 ROLLER



REF.
385

Carcasa + 2 Rodamientos
Shell + 2 Rollers

TAPETA MC-30 NYLON

MC-30 END COVER



REF.
3811

TAPETA MC-40 NYLON

MC-40 END COVER



REF.
3815

TAPETA A-135 NYLON

A-135 END COVER



REF.
3816

TAPETA TC-20 NYLON

TC-20 END COVER



REF.
3820

TAPETA R-4 NYLON

R-4 END COVER



REF.
3814

TAPETA OC-8 NYLON

OC-8 END COVER



REF.
3818

PORTAESTANTES ALUMINIO

PANEL CLAMP



REF.
3913

PORTAESTANTES 2 PIEZAS

2 PZ. PANEL CLAMP



REF.
3911

PORTAESTANTES 3 PIEZAS

3 PZ. PANEL CLAMP



REF.	ACABADOS / FINISHINGS
39120	(oro / gold)
3912P	(plata / silver)

PRENSA MANUAL GRAPA / TENSOR

HAND DRILLING JIG FOR JOINTS

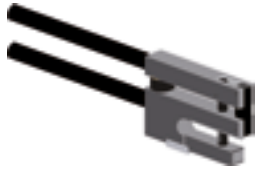

REF.
3894

CERRADURA PERFIL CC11

LOCK



REF.	ACABADOS / FINISHINGS
38420	(oro / gold)
3842P	(plata / silver)

INSERTO PIE M8

M8 THREADED INSERT



REF.
38731

PRENSA GRAPA / TENSOR

DRILLING JIG FOR JOINTS



REF.
3893

PIE REGULABLE M10

M10 ADJUSTABLE FEET



REF.
3871

PIE REGULABLE M8

M8 ADJUSTABLE FEET



REF.
3873

TUERCA ANTI DESLIZANTE M4

M4 SPRING NUT



REF.
52024

TUERCA ANTI DESLIZANTE M5

M5 SPRING NUT



REF.
52025

TUERCA ANTI DESLIZANTE M6

M6 SPRING NUT



REF.
52026

TUERCA ANTI DESLIZANTE M8

M8 SPRING NUT



REF.
52028

S20

ADINOR

MC-20

PERFIL MC-20
MC-20 PROFILE



E-20

PERFIL E-20
E-20 PROFILE

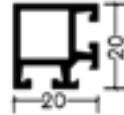

O-S

PERFIL O-S
O-S PROFILE



1-S

PERFIL 1-S
1-S PROFILE



6m. Condiciones especiales de envío

6m. Special shipping conditions

ACABADOS	FINISHINGS	Longitud / Length : 6 m.	Longitud / Length : 6 m.	Longitud / Length : 6 m.	Longitud / Length : 6 m.
LACADOS	COATED	REF.	REF.	REF.	REF.
Blanco	White	M251.L.B	M255.L.B	M201.L.B	M211.L.B
ANODIZADOS	ANODIZED	REF.	REF.	REF.	REF.
Inox	Inox	M251.A.X	M255.A.X	M201.A.X	M211.A.X
Plata Mate	Natural Anodized	M251.A.PM	M255.A.PM	M201.A.PM	M211.A.PM
SIN ANODIZAR	NO ANODIZED	REF.	REF.	REF.	REF.
Crudo	Raw	M251.A.C	M255.A.C	M201.A.C	M211.A.C

3-S

PERFIL 3-S
3-S PROFILE

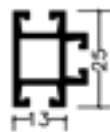

4-S

PERFIL 4-S
4-S PROFILE



CR-18

PERFIL CR-18
CR-18 PROFILE

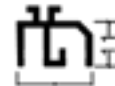

CC-8

PERFIL CC-8
CC-8 PROFILE



ACABADOS	FINISHINGS	Longitud / Length : 6 m.	Longitud / Length : 6 m.	Longitud / Length : 6 m.	Longitud / Length : 6 m.
LACADOS	COATED	REF.	REF.	REF.	REF.
Blanco	White	M233.L.B	M242.L.B	M271.L.B	M272.L.B
ANODIZADOS	ANODIZED	REF.	REF.	REF.	REF.
Inox	Inox	M233.A.X	M242.A.X	M271.A.X	M272.A.X
Plata Mate	Natural Anodized	M233.A.PM	M242.A.PM	M271.A.PM	M272.A.PM
SIN ANODIZAR	NO ANODIZED	REF.	REF.	REF.	REF.
Crudo	Raw	M233.A.C	M242.A.C	M271.A.C	M272.A.C

S20

ADINOR

GI-14

PERFIL GI-14
GI-14 PROFILE



NUDO MC-20

NUDO MC-20 ZAMAK
MC-20 ZAMAK TRIPLE
CONNECTION ANGLE



NUDO E-20

NUDO E-20 ZAMAK
E-20 ZAMAK TRIPLE
CONNECTION ANGLE



6m. Condiciones especiales de envío
6m. Special shipping conditions



ACABADOS	FINISHINGS	Longitud / Length : 6 m.		
LACADOS	COATED	REF.	REF.	REF.
Blanco	White	M273.L.B	M3513B	M3553B
ANODIZADOS	ANODIZED	REF.	REF.	REF.
Inox	Inox	M273.A.X	-	-
Plata Mate	Natural Anodized	M273.A.PM	M3513PM	M3553PM
Plata Brillo	Polished Silver	-	M3513P	M3553P
SIN ANODIZAR	NO ANODIZED	REF.	REF.	REF.
Crudo	Raw	M273.A.C	M3513	M3553

GRAPA DE UNIÓN

PIN CONECTOR



REF.
M3761

+ ESPÁRRAGO
+SCREW

TAPETA MC-20 NYLON

MC-20 END COVER



REF.
M3811

TAPETA ESTRELLA NYLON

STAR END COVER



REF.
M3814

ESCUADRA VERTICAL NYLON

NYLON VERTICAL INTERIOR BRACKET 90°



REF.
M3781

ESCUADRA PLANA NYLON

NYLON FLAT INTERIOR BRACKET 90°



REF.
M3782

ESCUADRA CUADRANGULAR NYLON

NYLON INTERIOR BRACKET 90°



REF.
M3785

PORTAESTANTES INTERIOR

PANEL CLAMP



REF.
M3911

COJINETES CORREDERA CC-8

CC-8 ROLLER



REF.
M3852

Carcasa + 2 Rodamientos
Shell + 2 Rollers

BISAGRA PUERTA NYLON

NYLON HINGE



REF.
M3843

TIRADOR PUERTA NYLON

NYLON HANDLE



REF.
M3844

CERRADURA PERFIL CC-8

LOCKE



REF.	ACABADOS / FINISHINGS
M3842O	(oro / gold)
M3842P	(plata / silver)

TIRASORTE CRISTAL PVC

PVC SHELF SUPPORT PROFILE



REF.
M3411

JUEGO JUNQUILLO RÍGIDO PVC

CLAMPING PROFILE SET



REF.
M3431

JUEGO GOMA ACRISTALAR PVC

PVC GASKET



REF.
M3461

PERFIL CORREDERA SUPERIOR PVC

UPPER SLIDING DOOR PROFILE



REF.
M3421

PERFIL CORREDERA INFERIOR PVC

LOWER SLIDING DOOR PROFILE



REF.
M3422

TAPA-RANURA

GROOVE COVER PROFILE



REF.	Acabados	Finishings
M3441B	Blanco	White
M3441N	Negro	Black
M3441O	Oro	Gold
M3441M	Marrón	Brown

PLANTILLA MC-20

MC-20 DRILLING JIG FOR JOINTS



REF.
M3891

PLANTILLA 1-S

1-S DRILLING JIG FOR JOINTS



REF.
M3892

PRENSA (2 PUNZONES)

DRILLING JIG FOR JOINTS



REF.
M3893



SISTEMA RASOMURO

FLUSH DOOR SYSTEM

MARCO REVERSIBLE

REVERSIBLE ALUMINIUM FRAME

244

MARCO SIN PERFIL CABECERO

REVERSIBLE ALUMINIUM FRAME WITHOUT UPPER PROFILE

250

MARCO + PUERTA

REVERSIBLE FRAME + DOOR

256

ZÓCALOS

PLINZTH

264







CONCEPTO FUNCIONAL

LAS MEJORES MATERIAS PRIMAS, EL CONOCIMIENTO ARTESANO DE LOS TRABAJADORES QUE COMBINA LA TECNOLOGÍA MÁS AVANZADA DE NUESTRAS MÁQUINAS, EL DISEÑO EXCLUSIVO, LA BÚSQUEDA CONTINUA DE NUEVOS MODELOS, COLORES Y SOLUCIONES, EL RETO DIARIO PARA MEJORAR LA CALIDAD DE NUESTROS PRODUCTOS.

El marco técnico de aluminio raso muro Minimal se incorpora perfectamente en la pared, y la puerta queda integrada en el entorno creando un diseño que combina lo funcional y esencial. El color de la pared, el papel pintado, los murales y las decoraciones fluyen hacia la puerta sin interrupción. Integrando completamente todos los elementos del entorno.

La reversibilidad del sistema se determina durante la instalación: invierta el marco para definir la dirección (tirando o empujando) simplemente volteando el ala, puede establecer la dirección de apertura, derecha o izquierda.

Equipado con cerradura magnética y con bisagras ocultas que permiten la regulación en los tres ejes permitiendo una perfecta estabilidad y planitud de la puerta

De forma opcional se suministra una hoja lisa de 45mm de espesor, alveolar fabricada con tablero HDF de 7 mm y sello de calidad AITIM. Bastidor perimetral en madera y rechapado en PVC relacable a 4 lados encolado mediante adhesivo PUR , con refuerzo para cerradura. Fondo poliacrílico uv de gran adherencia (250 g/m²) lo que permite la fácil adhesión de pinturas y lacas.

SUMMARY

THE BEST RAW MATERIALS, THE WORKER'S CRAFT KNOWLEDGE THAT COMBINES THE MOST ADVANCED TECHNOLOGY OF OUR MACHINES, THE EXCLUSIVE DESIGN, THE CONTINUOUS SEARCH OF NEW MODELS, COLORS AND SOLUTIONS, THE DAILY CHALLENGE TO IMPROVE THE PRODUCTS.

The Minimal flush door aluminum technical frame is perfectly incorporated into the wall, and the door is integrated into the environment creating a design that combines the functional and essential. Wall color, wallpaper, murals, and decorations flow into the door without interruption. Completely integrating all the elements of the environment.

The reversibility of the system is determined during installation: reverse the frame to define the direction (pulling or pushing) by simply flipping the wing you can set the opening direction, right or left.

Flush door is equipped with a magnetic key lock and concealed hinges adjustable on three axes, to ensure extra stability.

Optionally it is supplied with a 45 mm thick, consisting on a solid dry wood perimetral frame, with an internal cellular structure, hot pressed with 7mm HDF board and AITIM quality seal and coated with Polyacrylic uv base with great adhesion (250 g / m²) which allows easy adhesion of paints and lacquers.

All the perimeter rabbets are coated with PVC primer film (including the lower one to prevent humidity) glued with PUR adhesive.

SISTEMA RASOMURO

FLUSH DOOR SYSTEM

ADINOR

MARCO ALUMINIO REVERSIBLE REVERSIBLE ALUMINIUM FRAME

GROSOR DE HOJA
DOOR THICKNESS

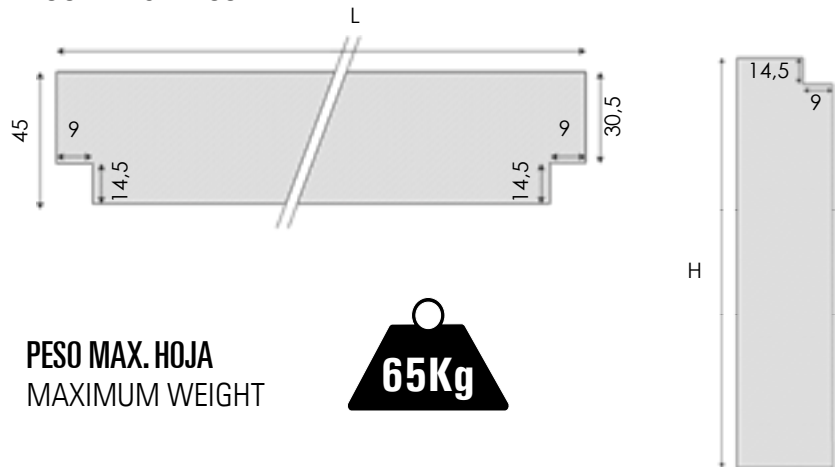

PESO MAX. HOJA
MAXIMUM WEIGHT



MONTAJE CARTON YESO
DRAYWALL ASSEMBLY

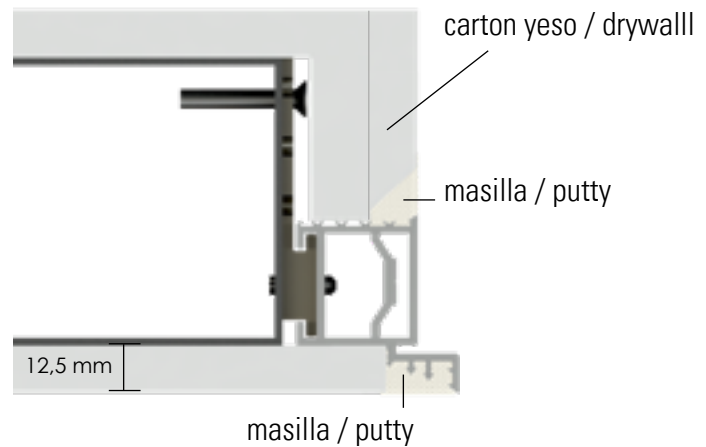

MONTAJE REVOQUE
MASONRY ASSEMBLY

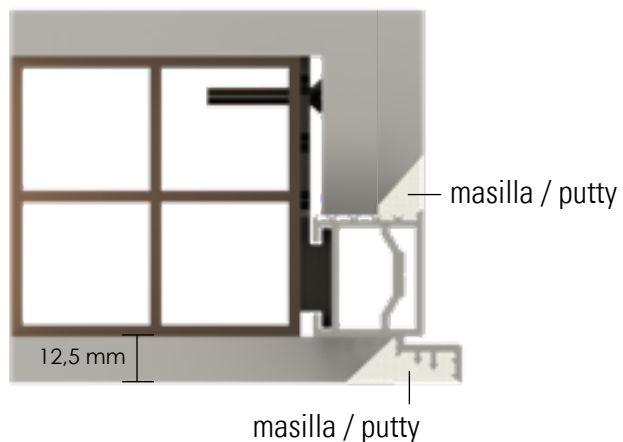

SISTEMA DE APERTURAS

REVERSIBLE OPENING SYSTEM

APERTURA EMPUJANDO IZQUIERDA
LEFT PUSH OPENING

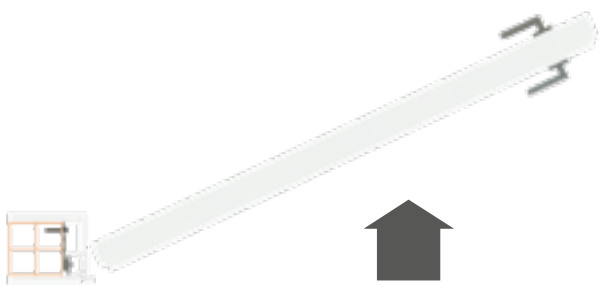

APERTURA EMPUJANDO DERECHA
RIGHT PUSH OPENING

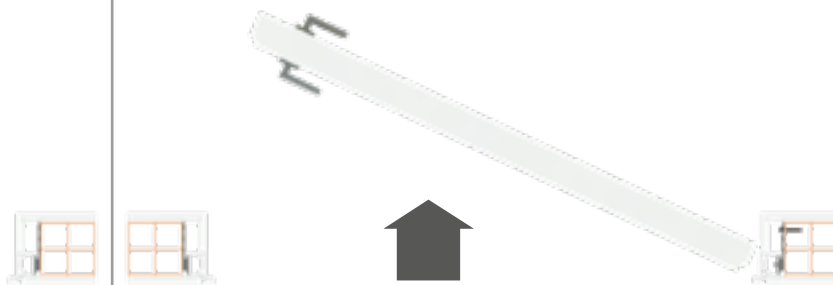

APERTURA TIRANDO IZQUIERDA
LEFT PULL OPENING

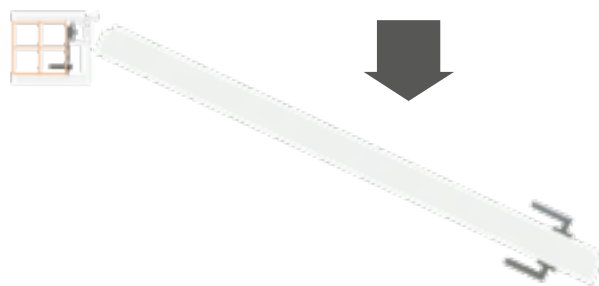

APERTURA TIRANDO DERECHA
RIGHT PULL OPENING

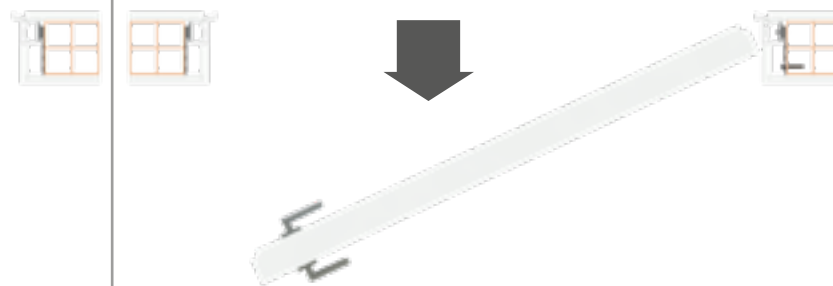

ANCHURAS DISPONIBLES

AVAILABLE WIDTHS

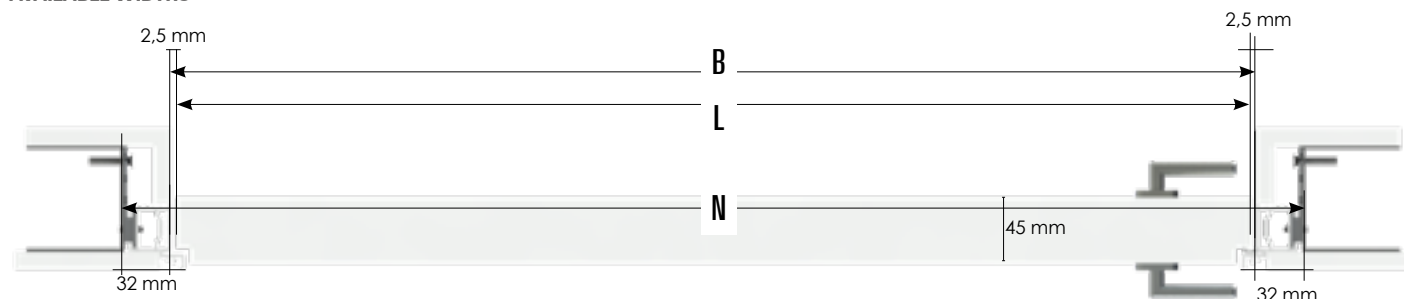

B= Ancho hueco interior entre marcos / Inner frame width

L= Anchura hoja / Door width

N= Anchura exterior entre marcos / Outer frame width

$$L = B - 2,5\text{mm} - 2,5\text{mm}$$

$$N = B + 64\text{mm}$$

ANCHURAS / WIDTH (L)	CERRADURA / LOCK	ALTURA / HEIGHT		
		2030 - 2190 mm (3 Bisagras / Hinges)	2190 - 2350 mm (3 Bisagras / Hinges)	2350 - 2550 mm (4 Bisagras / Hinges)
625 mm	Cilindro / Cylinder	MR.LB.60.C.S	MR.LB.60.C.M	MR.LB.60.C.L
	Condena / WC	MR.LB.60.W.S	MR.LB.60.W.M	MR.LB.60.W.L
725 mm	Cilindro / Cylinder	MR.LB.70.C.S	MR.LB.70.C.M	MR.LB.70.C.L
	Condena / WC	MR.LB.70.W.S	MR.LB.70.W.M	MR.LB.70.W.L
825 mm	Cilindro / Cylinder	MR.LB.80.C.S	MR.LB.80.C.M	MR.LB.80.C.L
	Condena / WC	MR.LB.80.W.S	MR.LB.80.W.M	MR.LB.80.W.L
925 mm	Cilindro / Cylinder	MR.LB.90.C.S	MR.LB.90.C.M	MR.LB.90.C.L
	Condena / WC	MR.LB.90.W.S	MR.LB.90.W.M	MR.LB.90.W.L
1025 mm	Cilindro / Cylinder	MR.LB.100.C.S	MR.LB.100.C.M	MR.LB.100.C.L
	Condena / WC	MR.LB.100.W.S	MR.LB.100.W.M	MR.LB.100.W.L

*El marco es reversible para mano izquierda o derecha y para empujar y tirar.

*The flush door aluminium frame could be used to push, pull, left and right opening.

COMPLEMENTOS INCLUIDOS: CERRADURA CB, CERRADERO CRB Y BISAGRAS BB
COMPLEMENTS INCLUDED: CB DOOR LOCK, CRB STRIKE PLATE AND BB CONCEALED HINGE

ALTURAS DISPONIBLES
AVAILABLE HEIGHTS

AJUSTABLE EN ALTURA
HEIGHT ADJUSTABLE

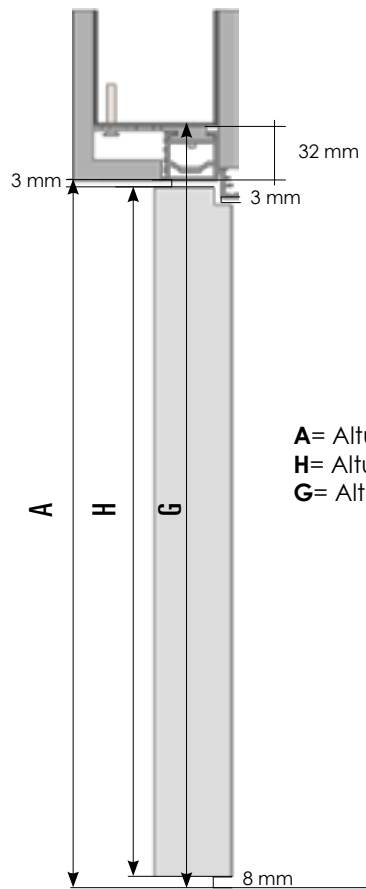

A= Altura libre de paso / Clearance height
H= Altura hoja / Door height
G= Altura pared necesaria / Wall opening height

$$H = A - 8\text{mm} - 3\text{mm}$$

$$G = A + 32\text{mm}$$

ALTURAS LIBRE DE PASO (A)
CLEARANCE HEIGHT (A)



2030 mm - 2190 mm



2190 mm - 2350 mm



2350 mm - 2550 mm

DETALLES DE MECANIZACIÓN DEL PERFIL

MACHINING PROFILE DETAILS

1.-Indistintamente de la altura del perfil elegida la distancia hasta el centro del mecanizado para la primera bisagra superior e inferior siempre será la misma. Esta distancia es de 200 mm al centro de la bisagra o de 133 mm al borde de la bisagra.

1.-Regardless of the chosen profile height, the distance to the center of the machining for the hinge will always be the same. This distance is 200mm to the center of the hinge or 133mm to the edge of the hinge.

2.- El corte del perfil puede realizarse en ambos lados si fuera necesario pero teniendo en cuenta que como mínimo debe dejar 53mm de distancia entre el extremo del perfil y el borde de la bisagra o de 120mm al centro de la bisagra.

2.- The profile can be cut on both sides if necessary but taking into account that at least 53mm of distance must be left between the end of the profile and the edge of the hinge or 120mm to the middle of the hinge.



DIMENSIÓN DEL PERFIL
2030-2190
2190-2350
2350-2550

3.- Se podrá cortar un total de **80mm** por cada extremo como **máximo**.

3.- **80mm** is the **maximum measure** can be cut at each sides.

MONTAJE ASSEMBLY

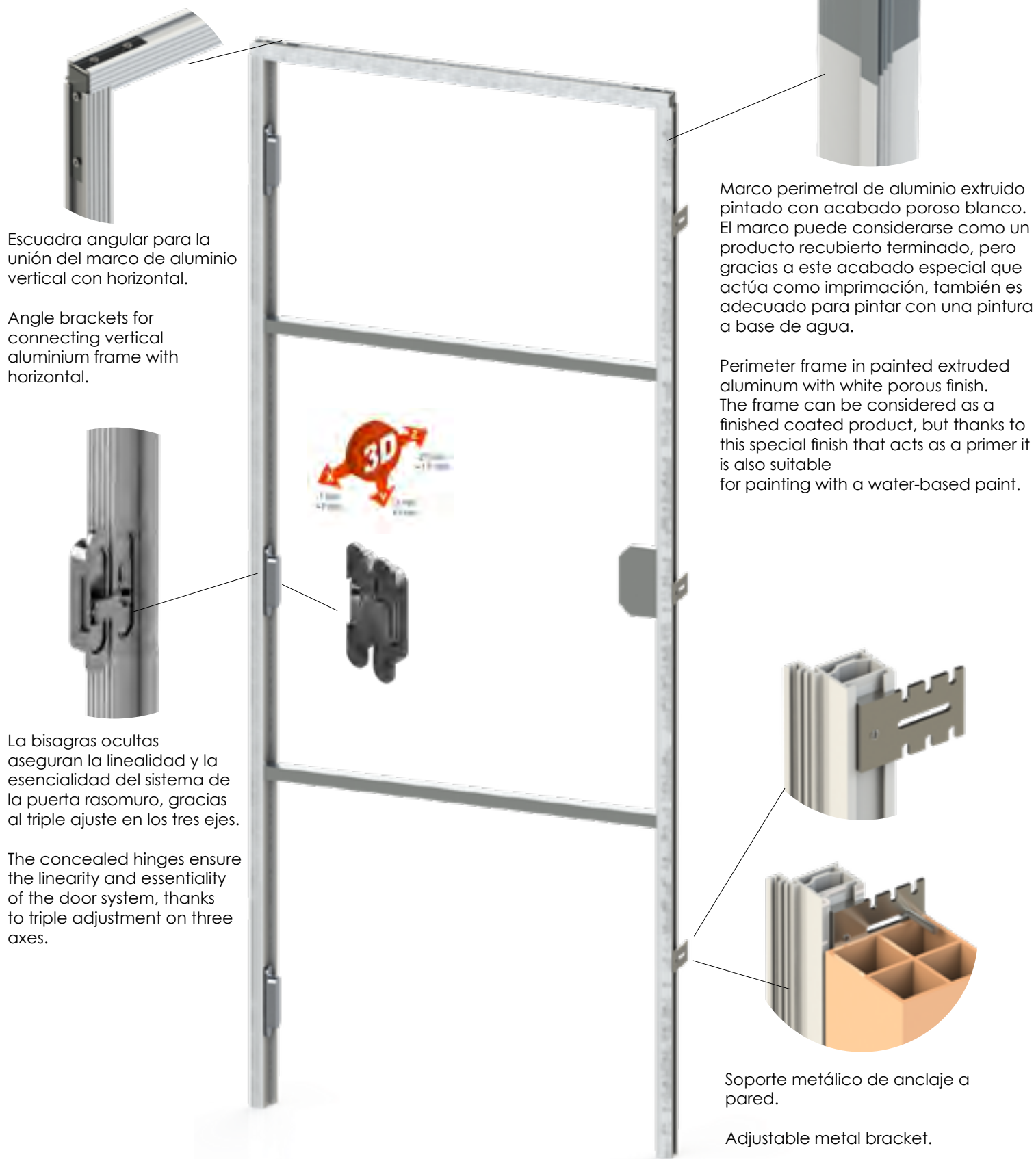

Escuadra angular para la unión del marco de aluminio vertical con horizontal.

Angle brackets for connecting vertical aluminium frame with horizontal.

La bisagras ocultas aseguran la linealidad y la esencialidad del sistema de la puerta rasomuro, gracias al triple ajuste en los tres ejes.

The concealed hinges ensure the linearity and essentiality of the door system, thanks to triple adjustment on three axes.

Marco perimetral de aluminio extruido pintado con acabado poroso blanco. El marco puede considerarse como un producto recubierto terminado, pero gracias a este acabado especial que actúa como imprimación, también es adecuado para pintar con una pintura a base de agua.

Perimeter frame in painted extruded aluminum with white porous finish. The frame can be considered as a finished coated product, but thanks to this special finish that acts as a primer it is also suitable for painting with a water-based paint.

Soporte metálico de anclaje a pared.

Adjustable metal bracket.

Todos los kits de maco raso muro reversibles contienen :

- (A) Marco completo aluminio según medida (2 verticales y un horizontal)
- (B) Refuerzos para facilitar el montaje aplomado (2un).
- (C) Soporte metálico anclaje pared (6un) carton yeso o revoque. En altura 2,35-2,55m. 8un
- (D) Cerradura y cerradero magnético (1 un)
- (E) Bisagras ocultas 3un. En altura 2,35-2,55m lleva 4 un
- (F) Goma Q-Ion perimetral antiruido

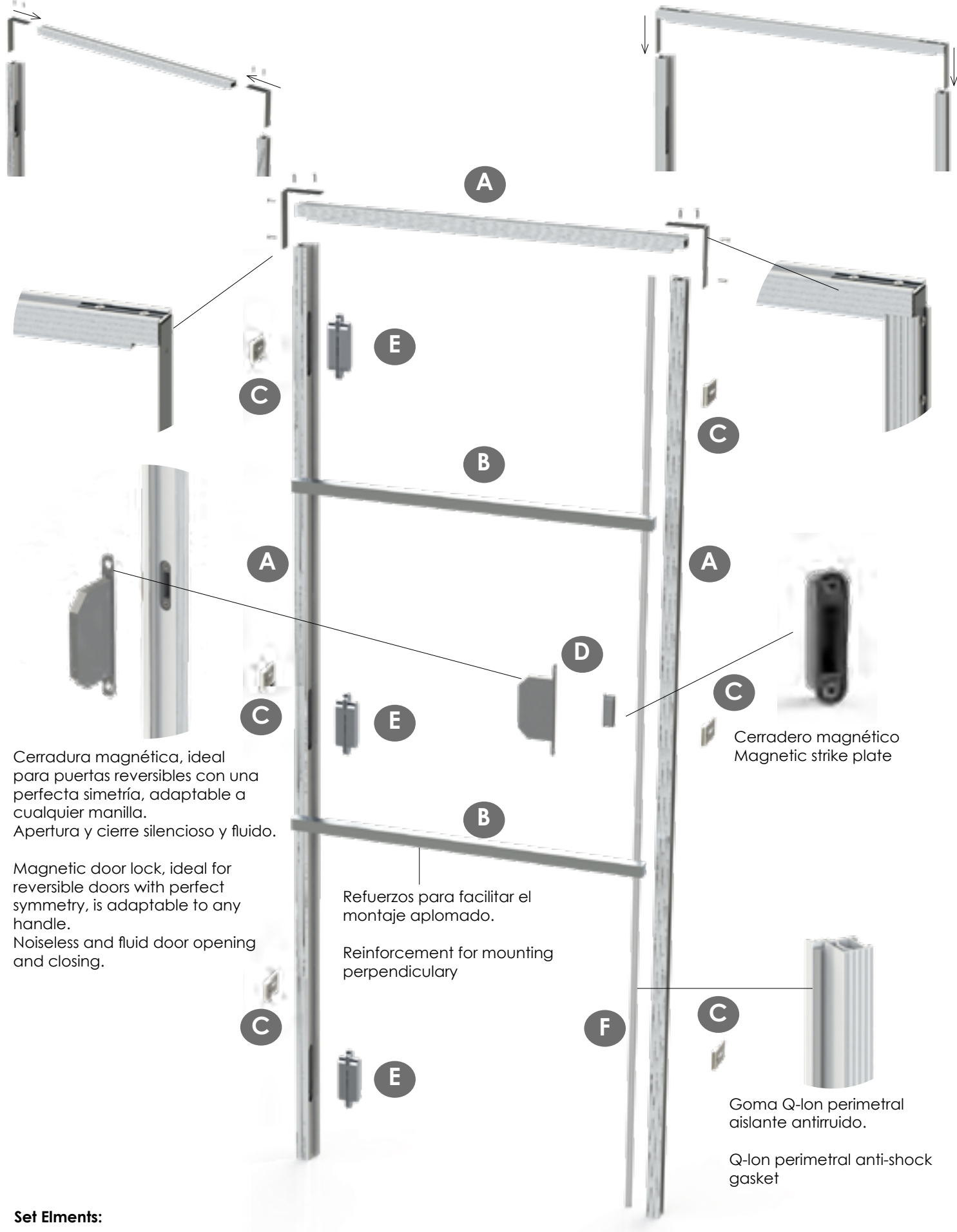

Cerradura magnética, ideal para puertas reversibles con una perfecta simetría, adaptable a cualquier manilla. Apertura y cierre silencioso y fluido.

Magnetic door lock, ideal for reversible doors with perfect symmetry, is adaptable to any handle. Noiseless and fluid door opening and closing.

Refuerzos para facilitar el montaje aplomado.

Reinforcement for mounting perpendicular

Cerradero magnético
Magnetic strike plate

Goma Q-lon perimetral
aislante antirruido.

Q-lon perimetral anti-shock
gasket

Set Elements:

- (A) Perimeter aluminium frame (2 vertical & 1 horizontal)
- (B) Reinforcement (2un)
- (C) Adjustable metal bracket (6un) for drywall or masonry. 2,35-2,55m height 8un
- (D) Magnetic lock and strike plate
- (E) Concealed hinges 3un. 2,35-2,55m height 4un
- (F) Q-lon perimetral anti-shock gasket

SISTEMA RASOMURO

FLUSH DOOR SYSTEM

ADINOR

MARCO ALUMINIO REVERSIBLE SIN CABECERO REVERSIBLE ALUMINIUM FRAME WITHOUT UPPER PROFILE

GROSOR DE HOJA
DOOR THICKNESS

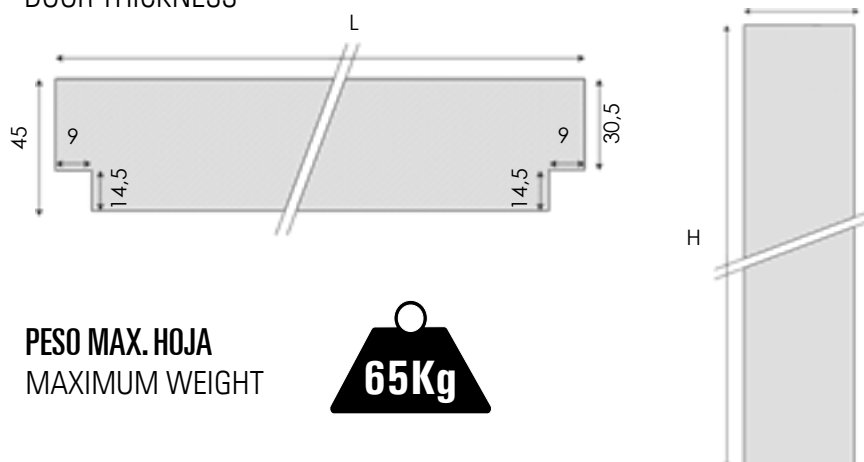

PESO MAX. HOJA
MAXIMUM WEIGHT



MONTAJE CARTON YESO
DRAYWALL ASSEMBLY

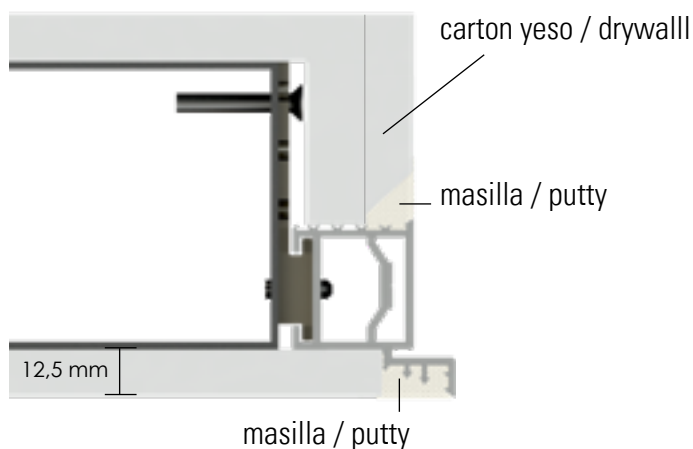

MONTAJE REVOQUE
MASONRY ASSEMBLY

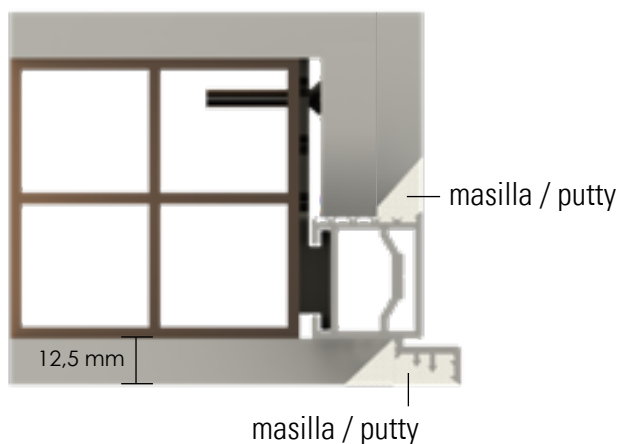

SISTEMA DE APERTURAS

REVERSIBLE OPENING SYSTEM

APERTURA EMPUJANDO IZQUIERDA
LEFT PUSH OPENING

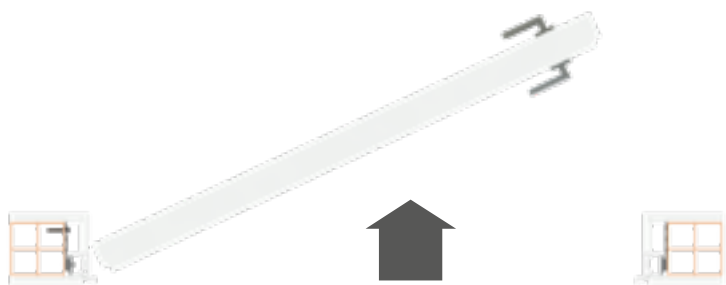

APERTURA EMPUJANDO DERECHA
RIGHT PUSH OPENING

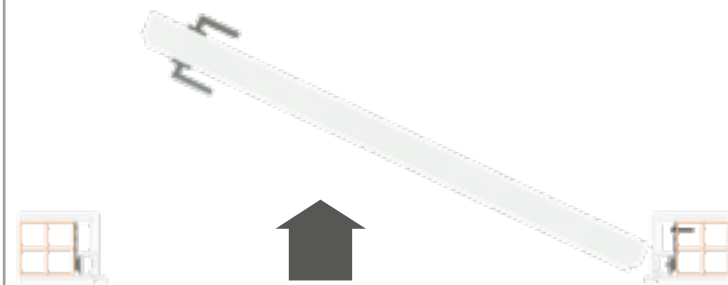

APERTURA TIRANDO IZQUIERDA
LEFT PULL OPENING

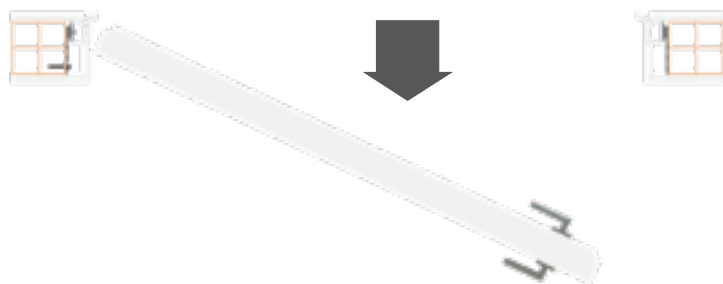

APERTURA TIRANDO DERECHA
RIGHT PULL OPENING

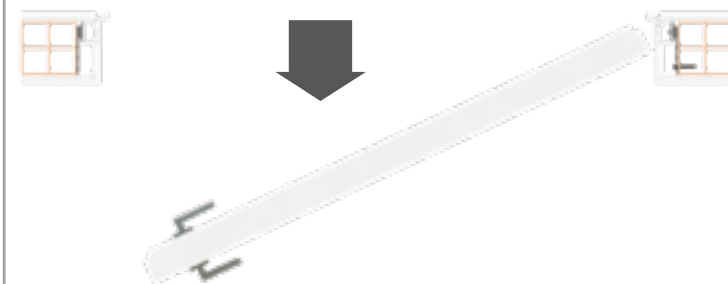

ANCHURAS DISPONIBLES

AVAILABLE WIDTHS

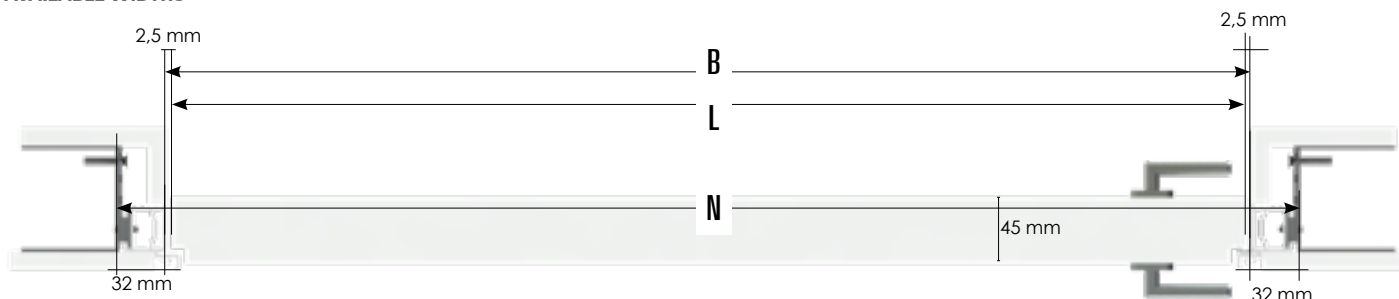

B= Ancho hueco interior entre marcos / Inner frame width

L= Anchura hoja / Door width

N= Anchura exterior entre marcos / Outer frame width

$$L = B - 2,5\text{mm} - 2,5\text{mm}$$

$$N = B + 64\text{mm}$$

CERRADURA / LOCK	ALTURA / HEIGHT		
	2030 - 2190 mm (3 Bisagras / Hinges)	2190 - 2350 mm (3 Bisagras / Hinges)	2350 - 2550 mm (4 Bisagras / Hinges)
Cilindro / Cylinder	MRSC.LB.C.S	MRSC.LB.C.M	MRSC.LB.C.L
Condena / WC	MRSC.LB.W.S	MRSC.LB.W.M	MRSC.LB.W.L

*El marco es reversible para mano izquierda o derecha y para empujar y tirar.

*The flush door aluminium frame could be used to push, pull, left and right opening.

COMPLEMENTOS INCLUIDOS: CERRADURA CB, CERRADERO CRB Y BISAGRAS BB
COMPLEMENTS INCLUDED: CB DOOR LOCK, CRB STRIKE PLATE AND BB CONCEALED HINGE

ALTURAS DISPONIBLES
AVAILABLE HEIGHTS

AJUSTABLE EN ALTURA
HEIGHT ADJUSTABLE

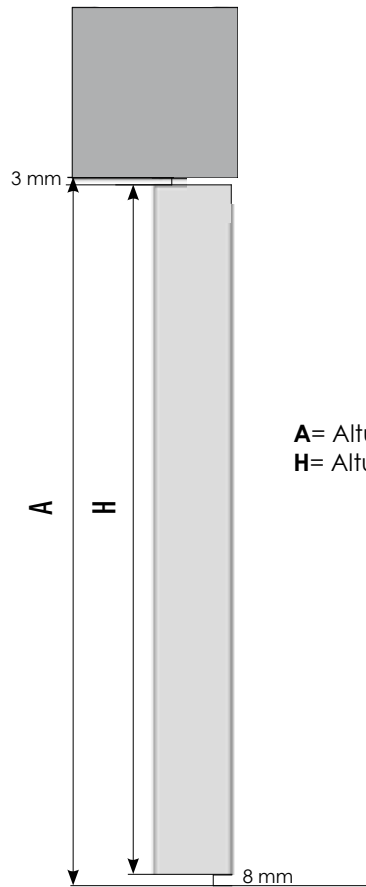

$$H = A - 8\text{mm} - 3\text{mm}$$

ALTURAS LIBRE DE PASO (A)
CLEARANCE HEIGHT (A)

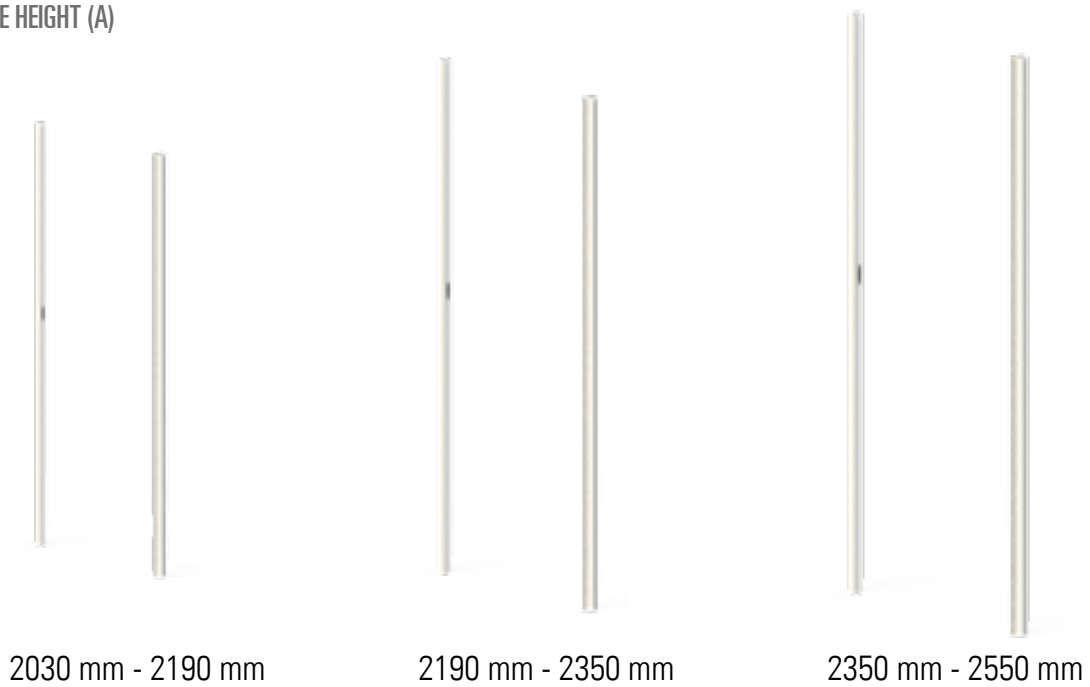

DETALLES DE MECANIZACIÓN DEL PERFIL

MACHINING PROFILE DETAILS

1.- Indistintamente de la altura del perfil elegida la distancia hasta el centro del mecanizado para la primera bisagra superior e inferior siempre será la misma. Esta distancia es de 200 mm al centro de la bisagra o de 133 mm al borde de la bisagra.

1.- Regardless of the chosen profile height, the distance to the center of the machining for the hinge will always be the same. This distance is 200mm to the center of the hinge or 133mm to the edge of the hinge.

2.- El corte del perfil puede realizarse en ambos lados si fuera necesario pero teniendo en cuenta que como mínimo debe dejar 53mm de distancia entre el extremo del perfil y el borde de la bisagra o de 120mm al centro de la bisagra.

2.- The profile can be cut on both sides if necessary but taking into account that at least 53mm of distance must be left between the end of the profile and the edge of the hinge or 120mm to the middle of the hinge.



DIMENSIÓN DEL PERFIL
2030-2190
2190-2350
2350-2550

3.- Se podrá cortar un total de **80mm** por cada extremo como **máximo**.

3.- **80mm** is the **maximum measure** can be cut at each sides.

MONTAJE ASSEMBLY



La bisagras ocultas aseguran la linealidad y la esencialidad del sistema de la puerta rasomuro, gracias al triple ajuste en los tres ejes.

The concealed hinges ensure the linearity and essentiality of the door system, thanks to triple adjustment on three axes.



Marco perimetral de aluminio extruido pintado con acabado poroso blanco. El marco puede considerarse como un producto recubierto terminado, pero gracias a este acabado especial que actúa como imprimación, también es adecuado para pintar con una pintura a base de agua.

Perimeter frame in painted extruded aluminum with white porous finish. The frame can be considered as a finished coated product, but thanks to this special finish that acts as a primer it is also suitable for painting with a water-based paint.



Soporte metálico de anclaje a pared.

Adjustable metal bracket.

Todos los kits de maco raso muro reversibles contienen :

- (A) Marco completo aluminio según medida (2 verticales)
- (B) Refuerzos para facilitar el montaje aplomado (2un).
- (C) Soporte metálico anclaje pared (6un) carton yeso o revoque. En altura 2,35-2,55m. 8un
- (D) Cerradura y cerradero magnético (1un)
- (E) Bisagras ocultas 3un. En altura 2,35-2,55m lleva 4 un
- (F) Goma Q-lon perimetral antiruido

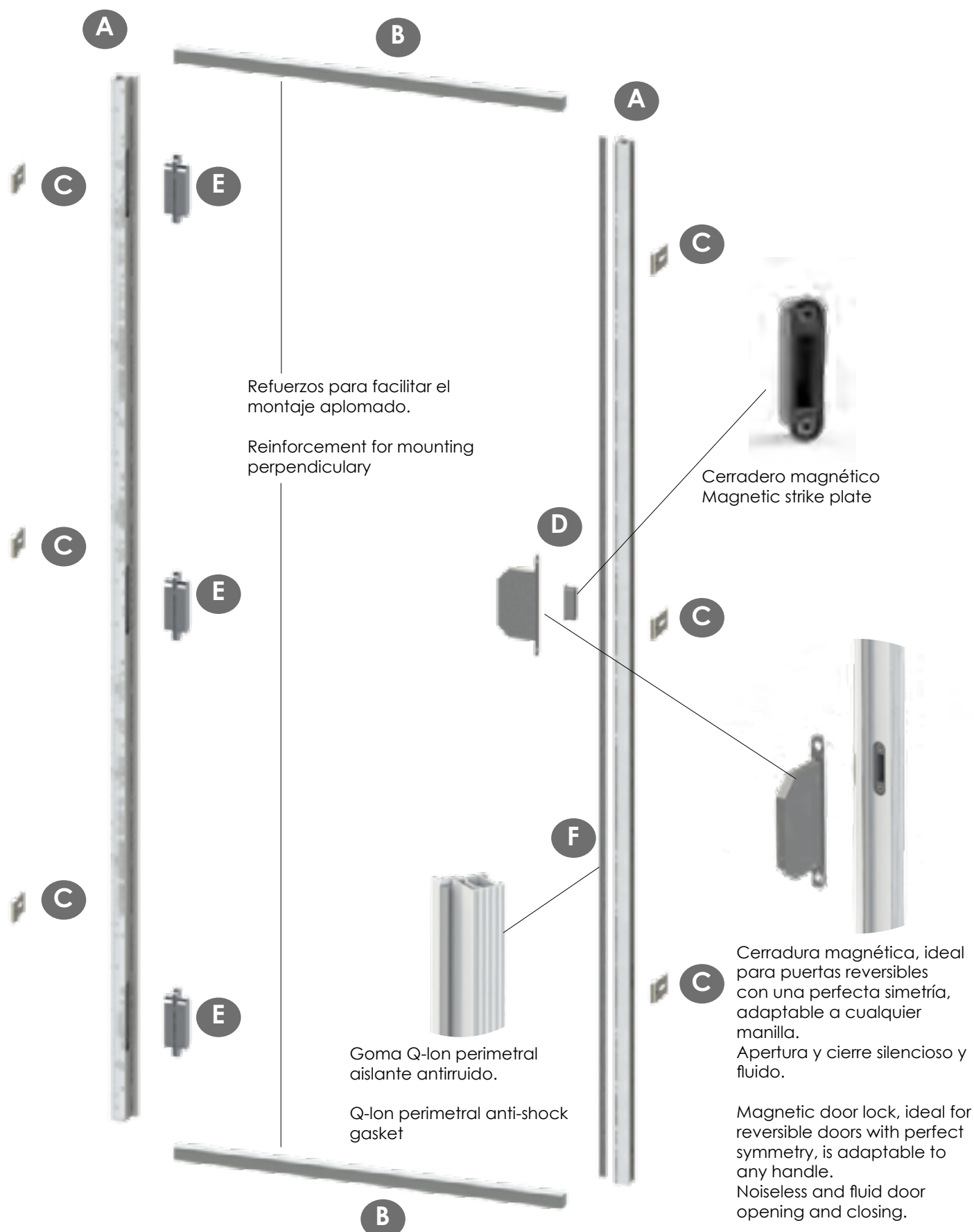

Set Elements:

- (A) Perimeter aluminium frame (2 vertical)
- (B) Reinforcement (2un)
- (C) Adjustable metal bracket (6un) for drywall or masonry. 2,35-2,55m height 8un
- (D) Magnetic lock and strike plate
- (E) Concealed hinges 3un. 2,35-2,55m height 4un
- (F) Q-lon perimetral anti-shock gasket

MARCO ALUMINIO REVERSIBLE + PUERTA PRELACADA

REVERSIBLE ALUMINIUM FRAME + PRE-PAINT DOOR

SISTEMA RASO MURO PATENTADO

FLUSH DOOR SYSTEM PATENTED

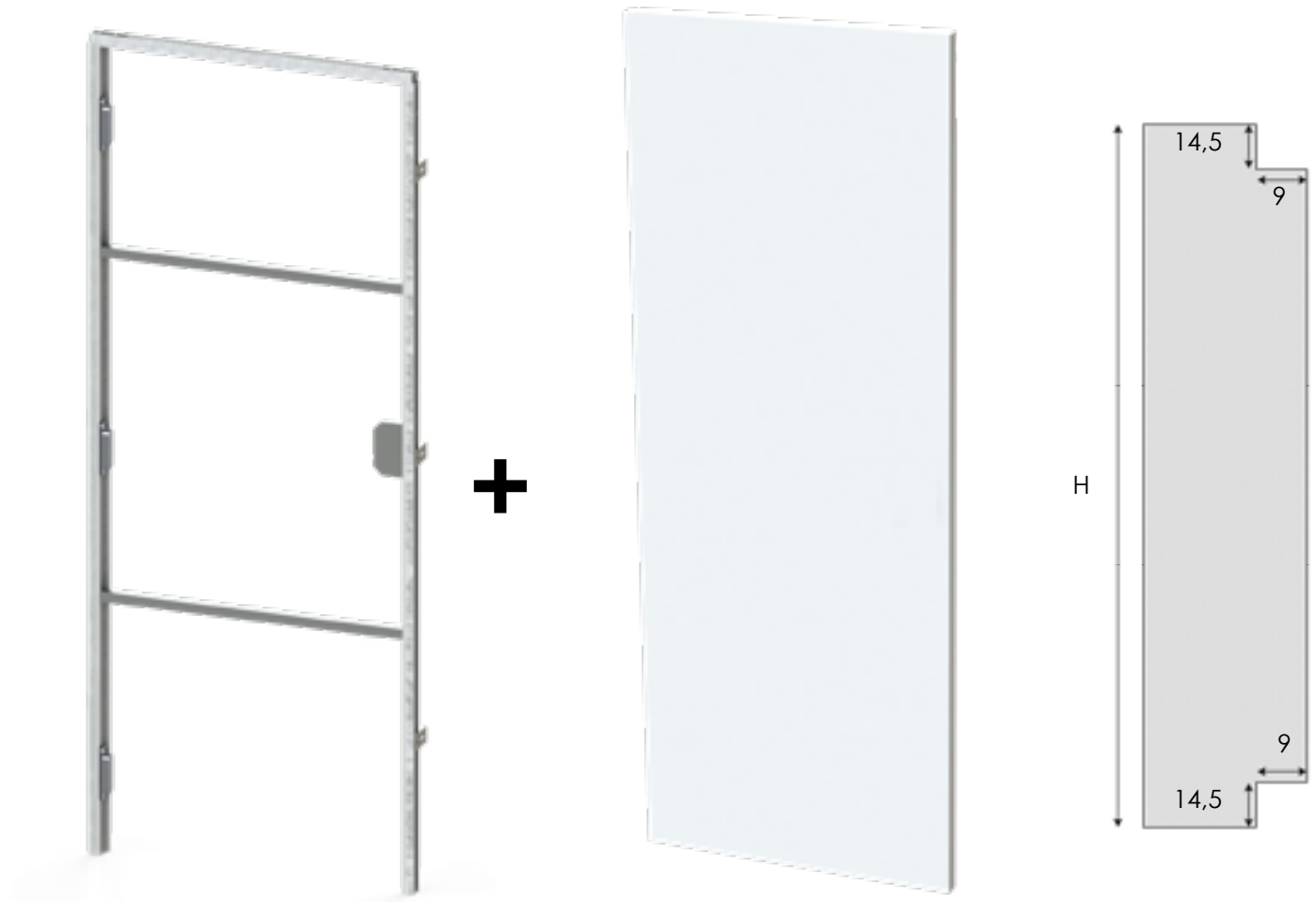

CARACTERÍSTICAS DEL SISTEMA RASO MURO MINIMAL + HOJA PRELACADA

CHARACTERISTICS OF THE MINIMAL FLUSH DOOR SYSTEM + PREPAINTED DOOR

- Sistema totalmente reversible pudiendo utilizarse para mano izquierda, derecha y para empujar o tirar.
- Equipado con cerradura magnética y con 3 bisagras ocultas que permiten la regulación en los tres ejes permitiendo una perfecta estabilidad y planitud de la hoja.
- Único sistema en el mercado que al voltear la puerta para cambiar la mano (izquierda o derecha) mantiene siempre la misma holgura en la parte superior del marco quedando la puerta totalmente integrada.
- La hoja suministrada es de 45mm de espesor, alveolar fabricada con tablero HDF de 7mm y sello de calidad AITIM. Bastidor perimetral en madera y rechapado en PVC relacable los 4 lados encolado mediante adhesivo PUR, con refuerzo para cerradura. Fondo poliacrílico uv de gran adherencia (250g/ m2) lo que permite la fácil adhesión de pinturas y lacas.
- Válido para construcción con cartón yeso y mampostería.
- Suministrado con goma perimetral anti-ruido que se ancla al marco.

- Totally reversible system that can be used for the left or right hand and for pushing or pulling.
- Equipped with a magnetic lock and 3 concealed hinges that allow regulation on all three axes allowing perfect stability and flatness of the door
- The only system on the market that when turning the door to change the hand (left or right) always maintains the same clearance in the upper part of the frame, leaving the door fully integrated.
- The supplied door is 45mm thick, consisting on a solid dry wood perimetral frame, with an internal cellular structure, hot pressed with 7mm HDF board and AITIM quality seal and coated with Polyacrylic uv base with great adhesion (250 g / m²) which allows easy adhesion of paints and lacquers. All the perimeter rabbets are coated with PVC primer film (including the lower one to prevent humidity) glued with PUR adhesive.
- Valid for construction with plasterboard and masonry.
- Supplied with anti-noise perimeter rubber that is anchored to the frame.

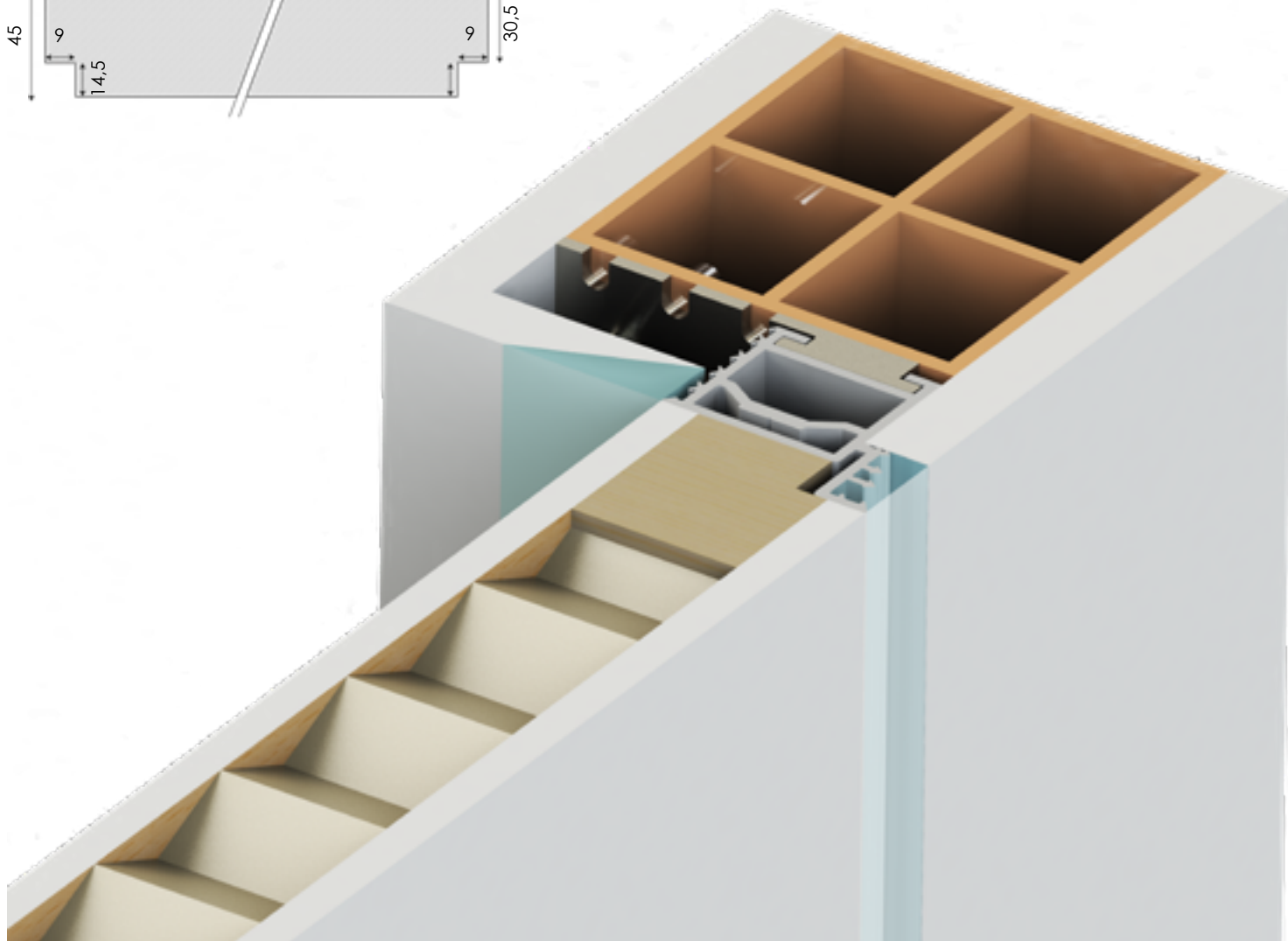
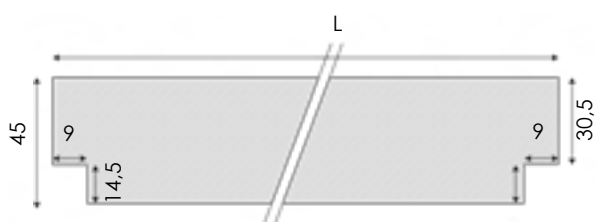

ALTURA Y ANCHURA DISPONIBLE

AVAILABLE WIDTHS AND HEIGHTS

ANCHURAS / WIDTH (L)	CERRADURA / LOCK	ALTURA / HEIGHT	
		2030mm	2110mm
625 mm	Cilindro / Cylinder	MRP.60.C.203	MRP.60.C.211
	Condena / WC	MRP.60.W.203	MRP.60.W.211
725 mm	Cilindro / Cylinder	MRP.70.C.203	MRP.70.C.211
	Condena / WC	MRP.70.W.203	MRP.70.W.211
825 mm	Cilindro / Cylinder	MRP.80.C.203	MRP.80.C.211
	Condena / WC	MRP.80.W.203	MRP.80.W.211
925 mm	Cilindro / Cylinder	MRP.90.C.203	MRP.90.C.211
	Condena / WC	MRP.90.W.203	MRP.90.W.211

*El marco es reversible para mano izquierda o derecha y para empujar y tirar.

*The flush door aluminium frame could be used to push, pull, left and right opening.

ANCHURAS DISPONIBLES

AVAILABLE WIDTHS

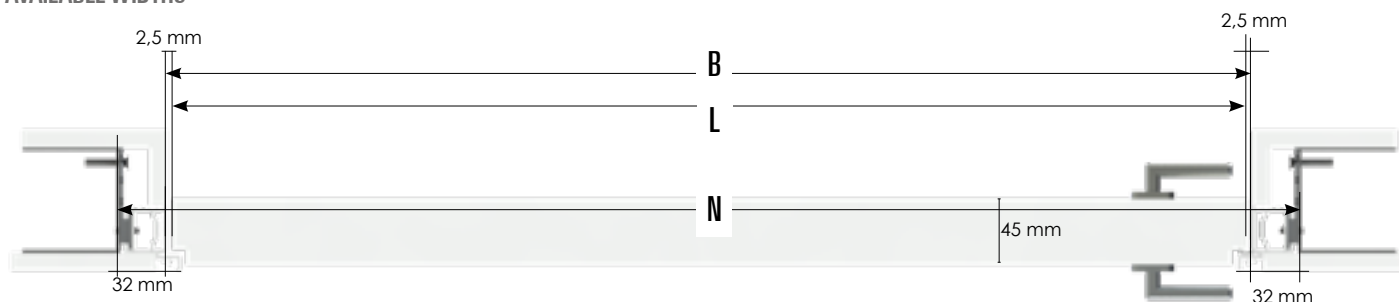

B= Ancho hueco interior entre marcos / Inner frame width

L= Anchura hoja / Door width

N= Anchura exterior entre marcos / Outer frame width

$$L = B - 2,5\text{mm} - 2,5\text{mm}$$

$$N = B + 64\text{mm}$$

ALTURAS DISPONIBLES

AVAILABLE HEIGHTS

AJUSTABLE EN ALTURA

HEIGHT ADJUSTABLE

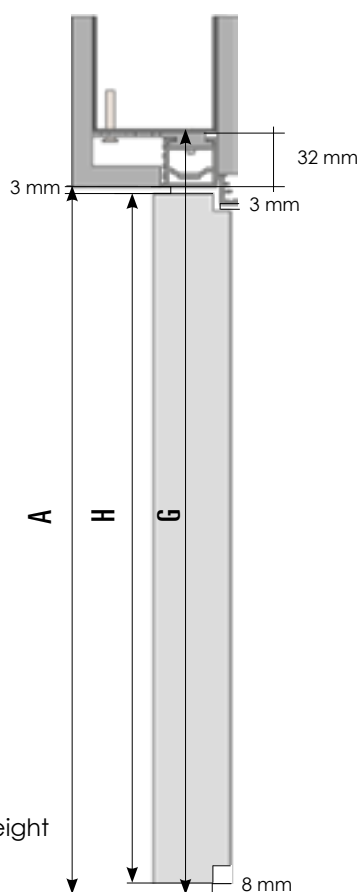

$$H = A - 8\text{mm} - 3\text{mm}$$

$$G = A + 32\text{mm}$$

A= Altura libre de paso / Clearance height

H= Altura hoja / Door height

G= Altura pared necesaria / Wall opening weight

AJUSTE ALTURA DEL MARCO Y DE LA PUERTA

FRAME HEIGHT ADJUSTABLE

1.- Indistintamente de la altura del perfil elegida la distancia hasta el centro del mecanizado para la primera bisagra superior e inferior siempre será la misma. Esta distancia es de 200 mm al centro de la bisagra o de 133 mm al borde de la bisagra.

1.- Regardless of the chosen profile height, the distance to the center of the machining for the hinge will always be the same. This distance is 200mm to the center of the hinge or 133mm to the edge of the hinge.

2.- El corte del perfil puede realizarse en ambos lados si fuera necesario pero teniendo en cuenta que como mínimo debe dejar 53mm de distancia entre el extremo del perfil y el borde de la bisagra o de 120mm al centro de la bisagra.

2.- The profile can be cut on both sides if necessary but taking into account that at least 53mm of distance must be left between the end of the profile and the edge of the hinge or 120mm to the middle of the hinge.

3.- Se podrá cortar un total de **80mm** por cada extremo como **máximo**.

3.- **80mm** is the **maximum measure** can be cut at each sides.

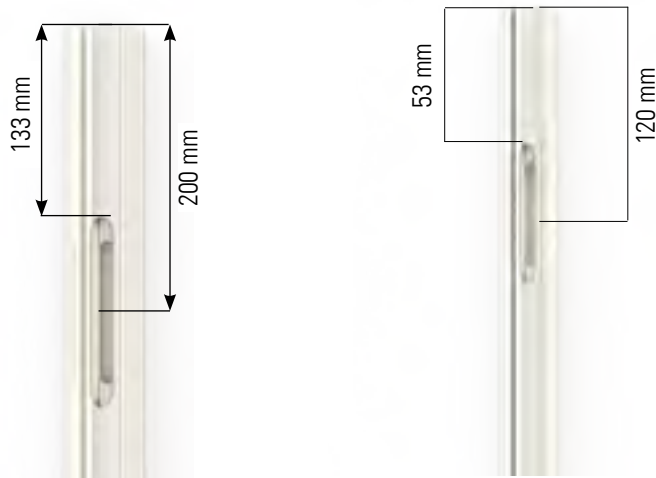
**AJUSTE ALTURA PUERTA**

DOOR HEIGHT ADJUSTABLE

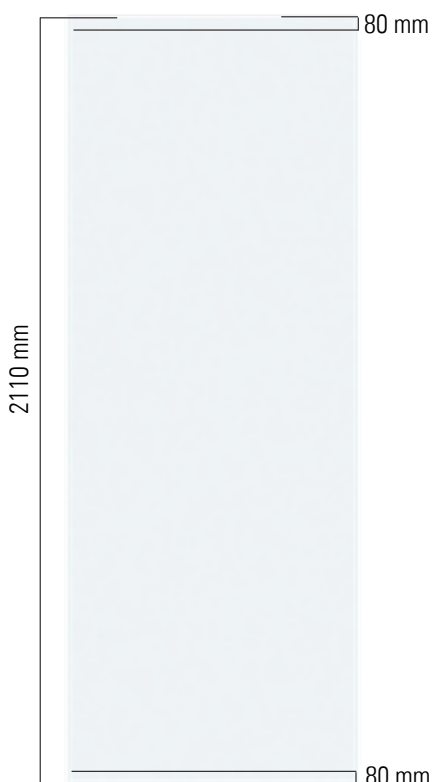
**SOLAMENTE PARA LA HOJA DE 2110mm****ONLY FOR 2110mm HIGH DOOR**

Por las características técnicas de fabricación, permite poder realizar un corte de hasta 80mm en la parte superior e inferior de la misma.

Due to the technical manufacturing characteristics, door allows us to make a cut of up to 80mm at the top and bottom.

Se recomienda que el corte se realice:

- Después de haber seleccionado la mano de la puerta (izquierdas ò derechas)
- En la parte superior de la puerta para evitar problemas de humedad

The cut should be made:

- After selecting the door hand (left or right)
- At the top of the door to avoid moisture problems

BISAGRA OCULTA BB

CONCEALED HINGE

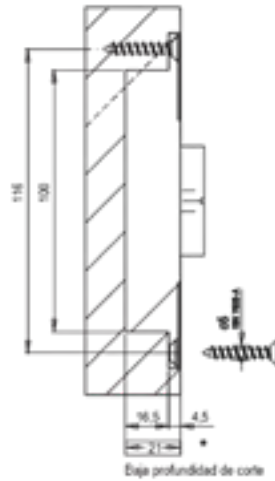
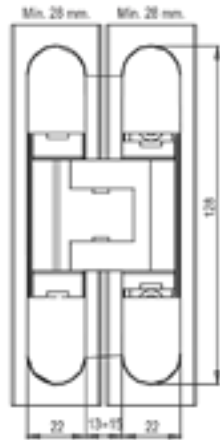

65Kg

ACABADOS	REF.
NEGRO	MR.BB.N
BLANCO	MR.BB.B
CROMO SATINADO	MR.BB.CS

BISAGRA OCULTA BK

CONCEALED HINGE

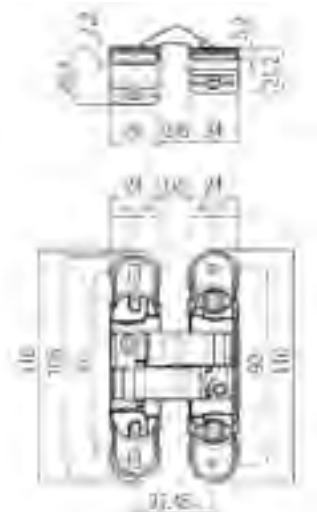

52Kg

ACABADOS	REF.
NEGRO	MR.BK.N
BLANCO	MR.BK.B
CROMO SATINADO	MR.BK.CS

CERRADERO CRB

MAGNETIC STRIKE PLATE

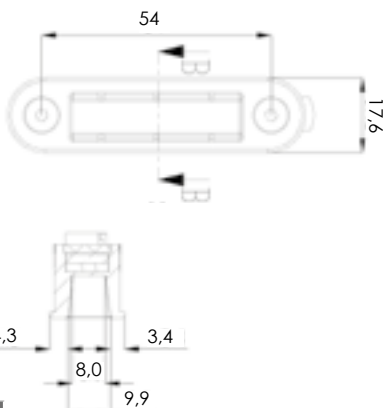

ACABADOS	REF.
NEGRO	MR.CRB.N
BLANCO	MR.CRB.B
GRIS	MR.CRB.P

Válido PARA CERRADURA MAGNÉTICA CB
VALID FOR CB MAGNETIC LOCK

CERRADERO CRA

MAGNETIC STRIKE PLATE

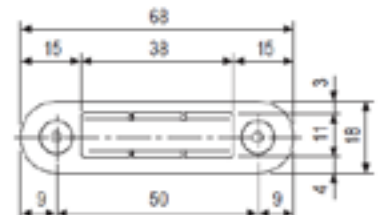

REF.
MR.CRA

Válido PARA CERRADURA MAGNÉTICA CA
VALID FOR CA MAGNETIC LOCK

CERRADURA MAGNETICA CB CILINDRO

CYLINDER MAGNETIC LOCK (CB)

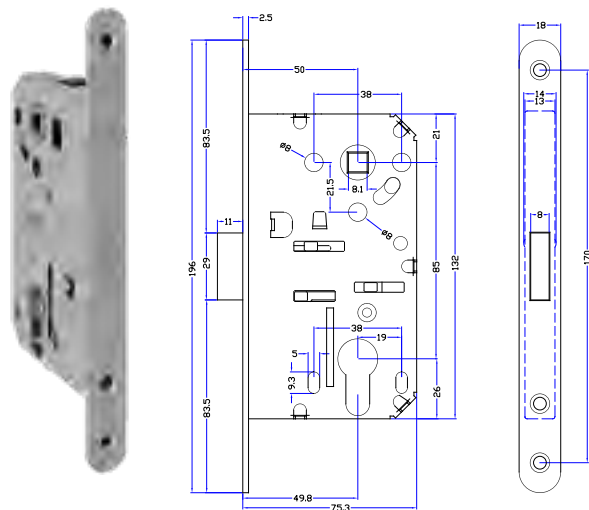

ACABADOS	REF.
NEGRO	MR.CB.C.N
BLANCO	MR.CB.C.B
CROMO SATINADO	MR.CB.C.P

CERRADURA MAGNETICA CB CONDENA

WC MAGNETIC LOCK (CB)

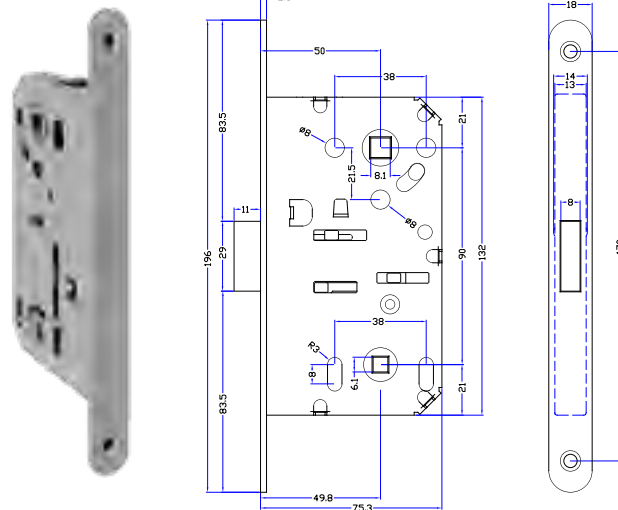

ACABADOS	REF.
NEGRO	MR.CB.WC.N
BLANCO	MR.CB.WC.B
CROMO SATINADO	MR.CB.WC.P

CERRADURA MAGNETICA CA CILINDRO

CYLINDER MAGNETIC LOCK (CA)



REF.
MR.CA.C

CERRADURA MAGNETICA CA CONDENA

WC MAGNETIC LOCK (CA)

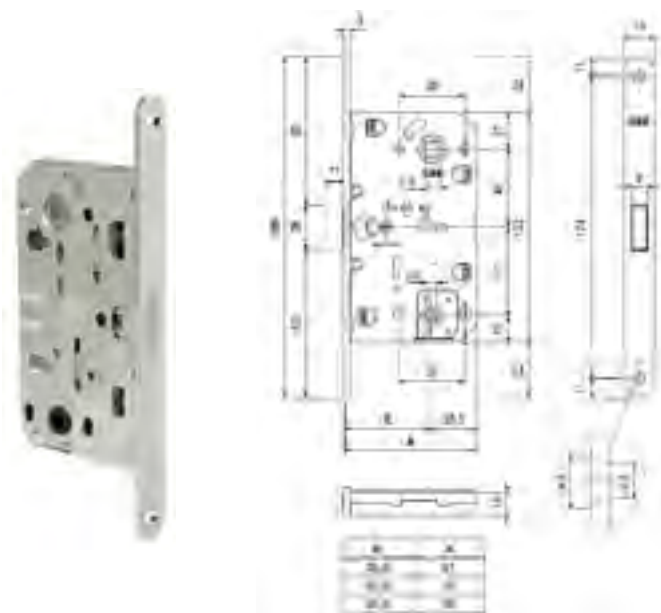

REF.
MR.CA.WC

MANETA ESPIRIT

HANDLE ESPIRIT



REF.
MR.900

MANETA ESPIRIT CON CONDENA

HANDLE ESPIRIT WITH WC



REF.

MR.910

ZÓCALOS ALUMINIO ALUMINIUM PLINZTH ADINOR

ZÓCALOS DE ALUMINIO ALUMINIUM PLINZTH

ZÓCALO DE ALUMINIO MISTIC ALUMINIUM MISTIC PLINZTH



Longitud / Length : 4 m.

ACABADO	FINISHING	
ANODIZADOS	ANODIZED	REF.
Plata Mate	Natural Anodized	Z.P.A.PM
LACADOS	COATED	REF.
Blanco Mate	Mat White	Z.P.L.BM03
Negro Mate	Mat Black	Z.P.L.NM
Repintable	Pre-paint	Z.P.L.T

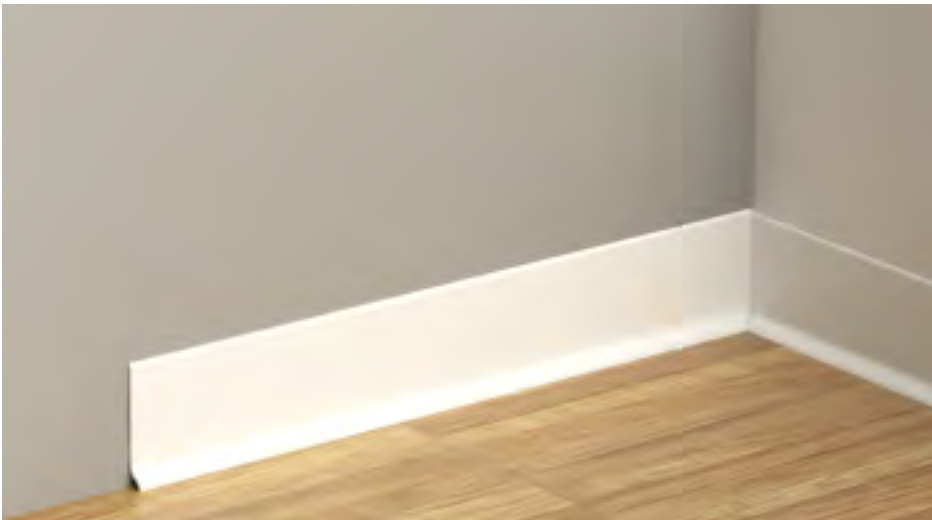

ZÓCALO DE ALUMINIO SINFONY

ALUMINIUM SINFONY PLINZTH

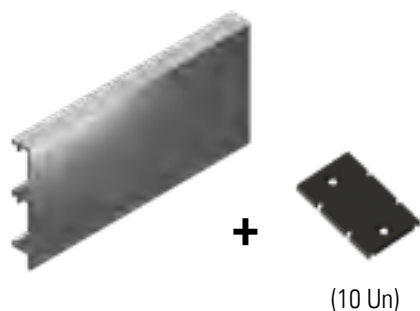

Longitud / Length : 4 m. + 10 clips-m

ACABADO	FINISHING	
ANODIZADOS	ANODIZED	REF.
Plata Mate	Natural Anodized	Z.PC.A.PM
LACADOS	COATED	REF.
Blanco Mate	Mat White	Z.PC.L.BM03
Negro Mate	Mat Black	Z.PC.L.NM
Repintable	Pre-paint	Z.PC.L.T

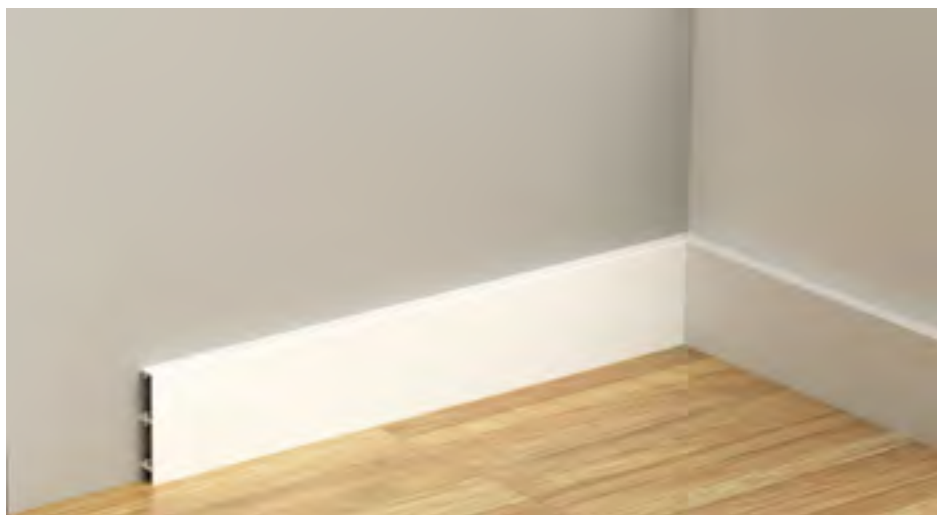

INSTALACIÓN SIN CABLEADO
NO WIRES ASSEMBLY



INSTALACIÓN CON CABLEADO
WIRES ASSEMBLY

ZÓCALO DE ALUMINIO LINER

ALUMINIUM LINER PLINZTH

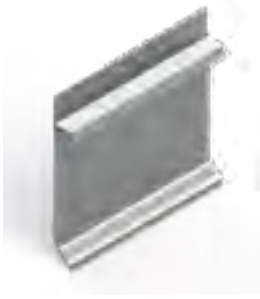

Longitud / Length : 4 m.

ACABADO	FINISHING	REF.
ANODIZADOS	ANODIZED	REF.
Plata Mate	Natural Anodized	Z.L.A.PM
LACADOS	COATED	REF.
Blanco Mate	Mat White	Z.L.L.BM03
Negro Mate	Mat Black	Z.L.L.NM
Repintable	Pre-paint	Z.L.L.T

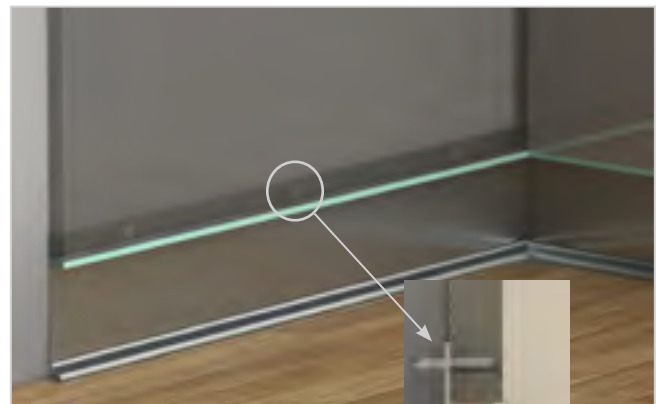

RODAPIE MDF ZOVI

COVERED MDF ZOVI PLINZTH



Longitud / Length : 4 m.

ACABADO	FINISHING	REF.
VINILO	VYNIL	REF.
Blanco RAL 9003	White RAL 9003	Z.DM.V.9003
MELAMINA	MELAMINE	REF.
Blanco rebarnizable	White	Z.DM.M.MR





REVESTIMIENTOS ALUMINIO PARA PARED Y TECHO

REVESTIMIENTO DE ALUMINIO PARED Y TECHO

ALUMINIUM "TIMBER" BATTENS

275

PANELADO DE PAREDES

ALUMINIUM BATTEN

278











REVESTIMIENTO DE ALUMINIO PARA PARED Y TECHO

ALUMINIUM "TIMBER" BATTENS

ADINOR

PERFIL CLIP ANCLAJE

BASE PROFILE SURFACE MOUNTING



PERFIL ANCLAJE CLIP ALTURA 15mm

COVER ALUMINIUM PROFILE SURFACE MOUNTING 15 mm HEIGHT

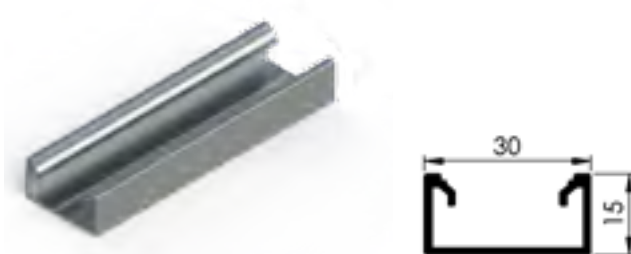

PERFIL ANCLAJE CLIP ALTURA 60mm

COVER ALUMINIUM PROFILE SURFACE MOUNTING 60 mm HEIGHT

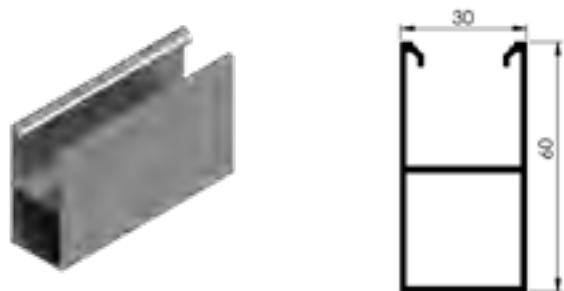

PERFIL ANCLAJE CLIP ALTURA 30mm

COVER ALUMINIUM PROFILE SURFACE MOUNTING 30 mm HEIGHT

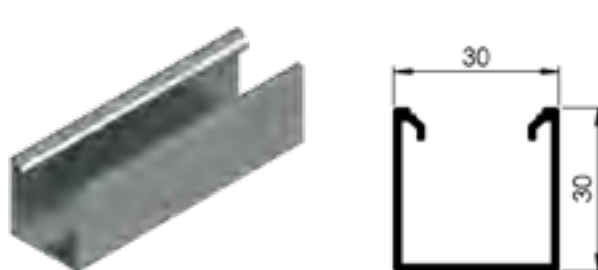

6m. Condiciones especiales de envío
6m. Special shipping conditions



Longitud / Length : 6 m.

Longitud / Length : 6 m.

Longitud / Length : 6 m.

Longitud / Length : 6 m.

ANODIZADOS	ANODIZED	REF.	REF.	REF.	REF.
Natural	Natural	-	-	-	RSPP.01.A.N
MADERA	NATURAL WOOD	REF.	REF.	REF.	REF.
Roble Francés	Oak	RSPP.10.C.RB	RSPP.20.C.RB	RSPP.30.C.RB	-
Sapely	Sapely	RSPP.10.C.SP	RSPP.20.C.SP	RSPP.30.C.SP	-
Cerezo	Cherry Tree	RSPP.10.C.CZ	RSPP.20.C.CZ	RSPP.30.C.CZ	-
Pino	Pine	RSPP.10.C.PN	RSPP.20.C.PN	RSPP.30.C.PN	-
Haya Blanca	Beech Tree	RSPP.10.C.Y	RSPP.20.C.Y	RSPP.30.C.Y	-
Haya Vaporizada	Steam Beech	RSPP.10.C.YV	RSPP.20.C.YV	RSPP.30.C.YV	-
Fresno	Ash Tree	RSPP.10.C.FN	RSPP.20.C.FN	RSPP.30.C.FN	-
VINILO	VINYL	REF.	REF.	REF.	REF.
Blanco Sil	Blanco Sil	RSPP.10.V.BS	RSPP.20.V.BS	RSPP.30.V.BS	-
Blanco Perla Touch	Blanco Perla T.	RSPP.10.V.BP	RSPP.20.V.BP	RSPP.30.V.BP	-
Blanco RAL 9003	Blanco RAL 9003	RSPP.10.V.9003	RSPP.20.V.9003	RSPP.30.V.9003	-
Halifax Natural	Halifax Natural	RSPP.10.V.HN	RSPP.20.V.HN	RSPP.30.V.HN	-
Halifax Tabaco	Halifax Tabaco	RSPP.10.V.HT	RSPP.20.V.HT	RSPP.30.V.HT	-
Halifax Blanco	Halifax White	RSPP.10.V.HB	RSPP.20.V.HB	RSPP.30.V.HB	-
Wengue Duero	Wengue Duero	RSPP.10.V.W	RSPP.20.V.W	RSPP.30.V.W	-
Palo Rosa Touch	Palo Rosa T.	RSPP.10.V.PRT	RSPP.20.V.PRT	RSPP.30.V.PRT	-



PANELADO DE PAREDES

ALUMINIUM BATTENS

ADINOR

PERFIL SUPERIOR

UPPER ALUMINIUM PROFILE

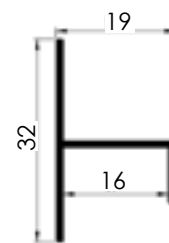
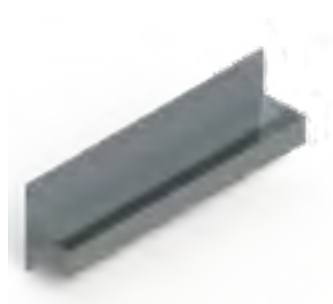

ACABADO	FINISHING	REF.
Plata Mate	Natural Anodized	RSP.40.A.PM
Negro Mate	Mat Black	RSP.40.L.NM

Longitud / Length : 2,75 m.

PERFIL UNION HORIZONTAL INTERMEDIA

HORIZONTAL INTERMEDIATE ALUMINIUM PROFILE

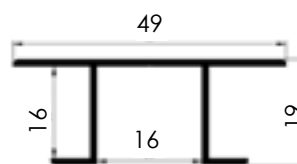
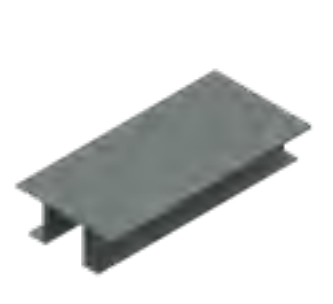

ACABADO	FINISHING	REF.
Plata Mate	Natural Anodized	RSP.50.A.PM
Negro Mate	Mat Black	RSP.50.L.NM

Longitud / Length : 2,75 m.

PERFIL UNIÓN ESQUINAS

90° JOINT ALUMINIUM PROFILE

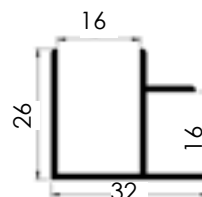
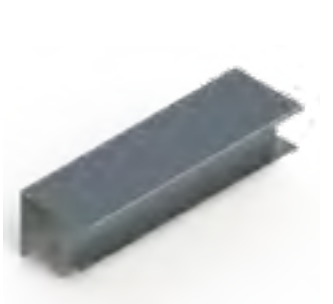

ACABADO	FINISHING	REF.
Plata Mate	Natural Anodized	RSP.60.A.PM
Negro Mate	Mat Black	RSP.60.L.NM

Longitud / Length : 2,75 m.

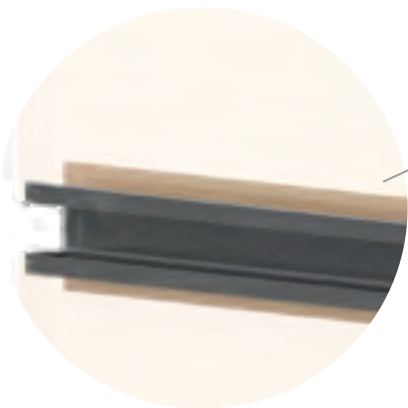

6m. Condiciones especiales de envío
6m. Special shipping conditions

PERFIL ALUMINIO 30x30 mm

30x30 mm ALUMINIUM PROFILE

Longitud / Length : 6 m.

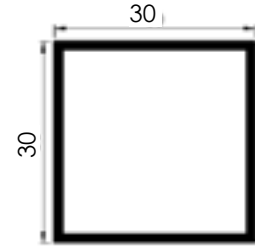

MADERA	NATURAL WOOD	REF.
Roble Francés	Oak	RSPP.70.C.RB
Sapely	Sapely	RSPP.70.C.SP
Cerezo	Cherry Tree	RSPP.70.C.CZ
Pino	Pine	RSPP.70.C.PN
Haya Blanca	Beech Tree	RSPP.70.C.Y
Haya Vaporizada	Steam Beech	RSPP.70.C.YV
Fresno	Ash Tree	RSPP.70.C.FN
VINILO	VINYL	REF.
Blanco Sil	Blanco Sil	RSPP.70.V.BS
Blanco Perla Touch	Blanco Perla T.	RSPP.70.V.BP
Blanco RAL 9003	Blanco RAL 9003	RSPP.70.V.9003
Halifax Natural	Halifax Natural	RSPP.70.V.HN
Halifax Tabaco	Halifax Tabaco	RSPP.70.V.HT
Halifax Blanco	Halifax White	RSPP.70.V.HB
Wengue Duero	Wengue Duero	RSPP.70.V.W
Palo Rosa Touch	Palo Rosa T.	RSPP.70.V.PRT

PERFIL ALUMINIO 30x150 mm

30x150 mm ALUMINIUM PROFILE

Longitud / Length : 6 m.

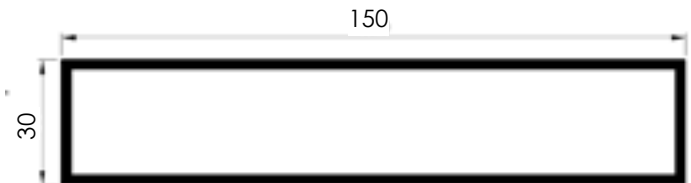
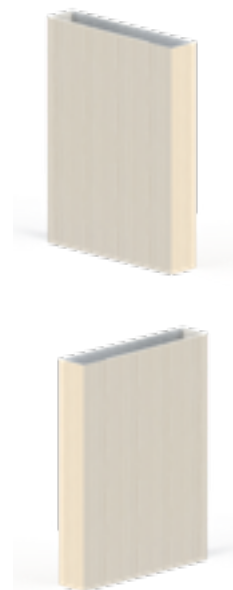

MADERA	NATURAL WOOD	REF.
Roble Francés	Oak	RSPP.80.C.RB
Sapely	Sapely	RSPP.80.C.SP
Cerezo	Cherry Tree	RSPP.80.C.CZ
Pino	Pine	RSPP.80.C.PN
Haya Blanca	Beech Tree	RSPP.80.C.Y
Haya Vaporizada	Steam Beech	RSPP.80.C.YV
Fresno	Ash Tree	RSPP.80.C.FN
VINILO	VINYL	REF.
Blanco Sil	Blanco Sil	RSPP.80.V.BS
Blanco Perla Touch	Blanco Perla T.	RSPP.80.V.BP
Blanco RAL 9003	Blanco RAL 9003	RSPP.80.V.9003
Halifax Natural	Halifax Natural	RSPP.80.V.HN
Halifax Tabaco	Halifax Tabaco	RSPP.80.V.HT
Halifax Blanco	Halifax White	RSPP.80.V.HB
Wengue Duero	Wengue Duero	RSPP.80.V.W
Palo Rosa Touch	Palo Rosa T.	RSPP.80.V.PRT



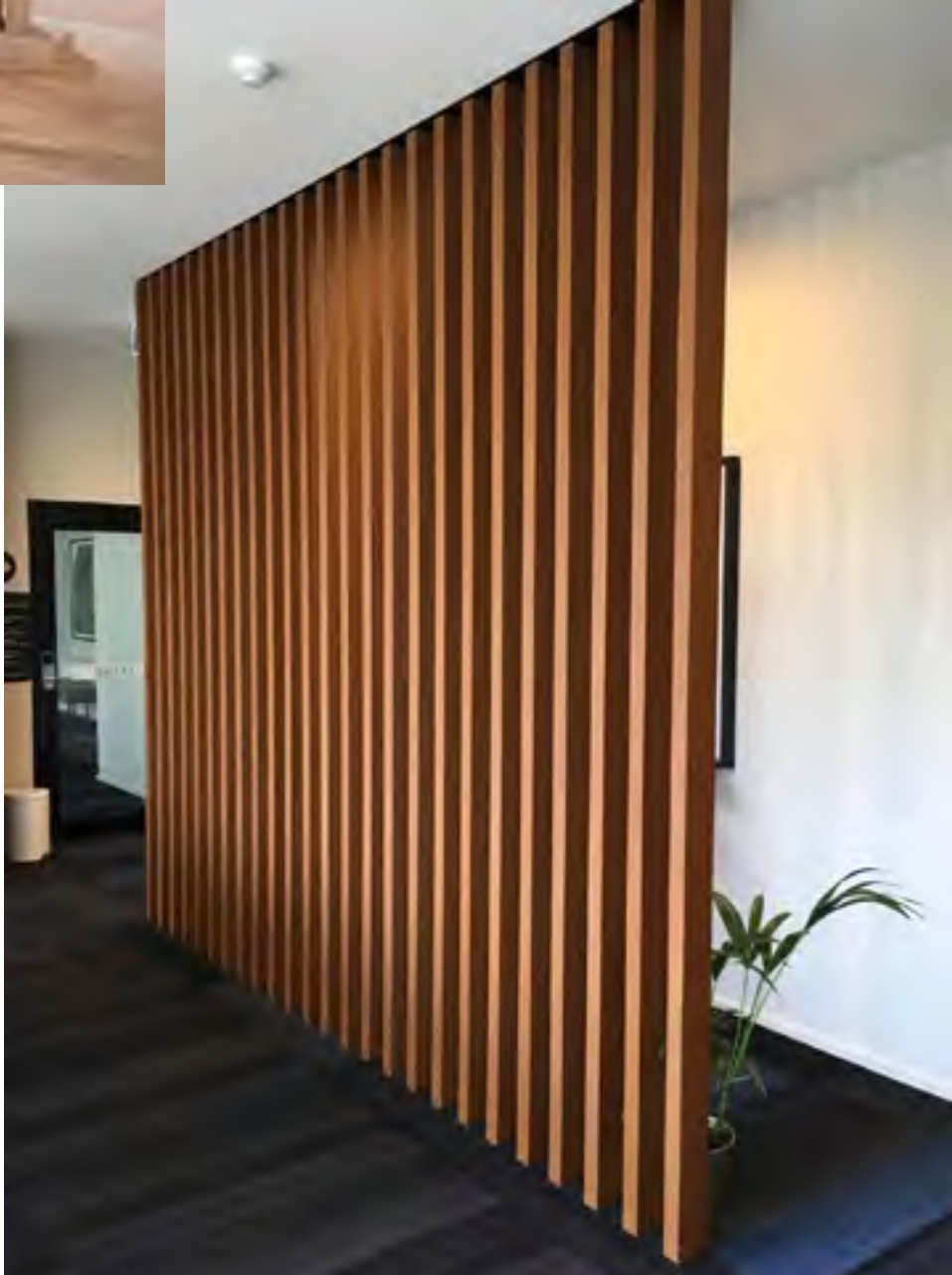

MARCOS DE ALUMINIO EXTENSIBLES

EXTENDABLE ALUMINIUM FRAMES

PUERTA ABATIBLE
FOLDING DOOR 290

SISTEMA CORREDERO
SLIDING DOOR 298

SISTEMA ANTIPILLADEDOS
SAFETY GASKET 308

PUERTA VAIVEN
REVOLVING DOOR 310

MARCO EMPLOMADO
LEAD REINFORCED FRAME 312

DIVISIONES HORIZONTALES
HORIZONTAL DOOR DIVISION 314

DIVISIONES VERTICALES
VERTICAL DOOR DIVISION 316









TIPOS DE MARCOS

ALUMINIUM FRAMES

ADINOR

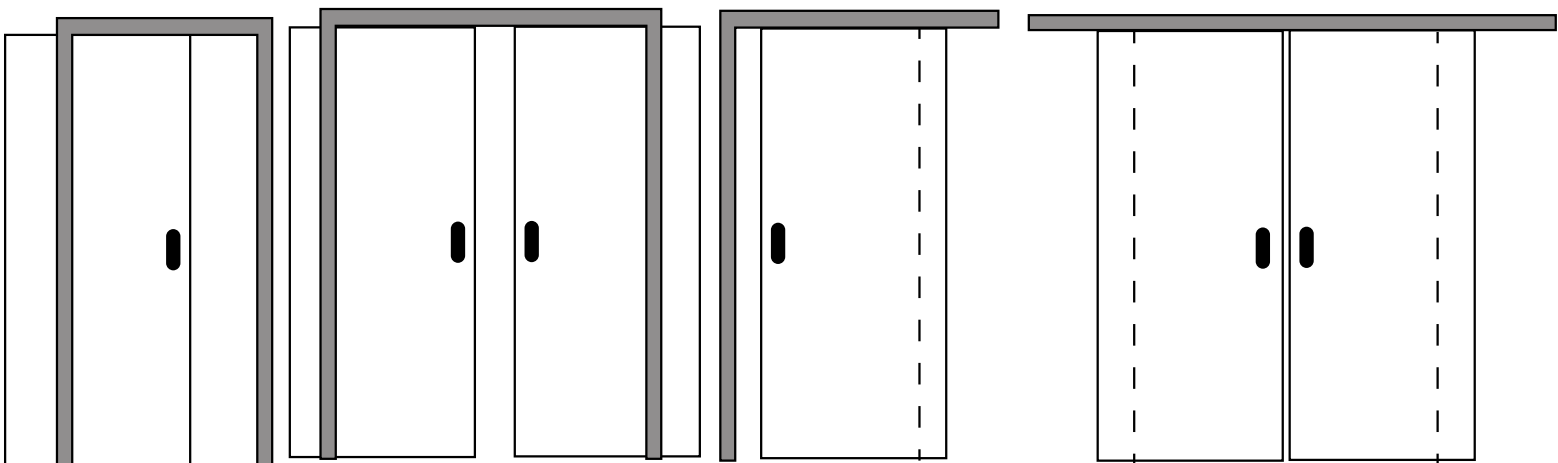
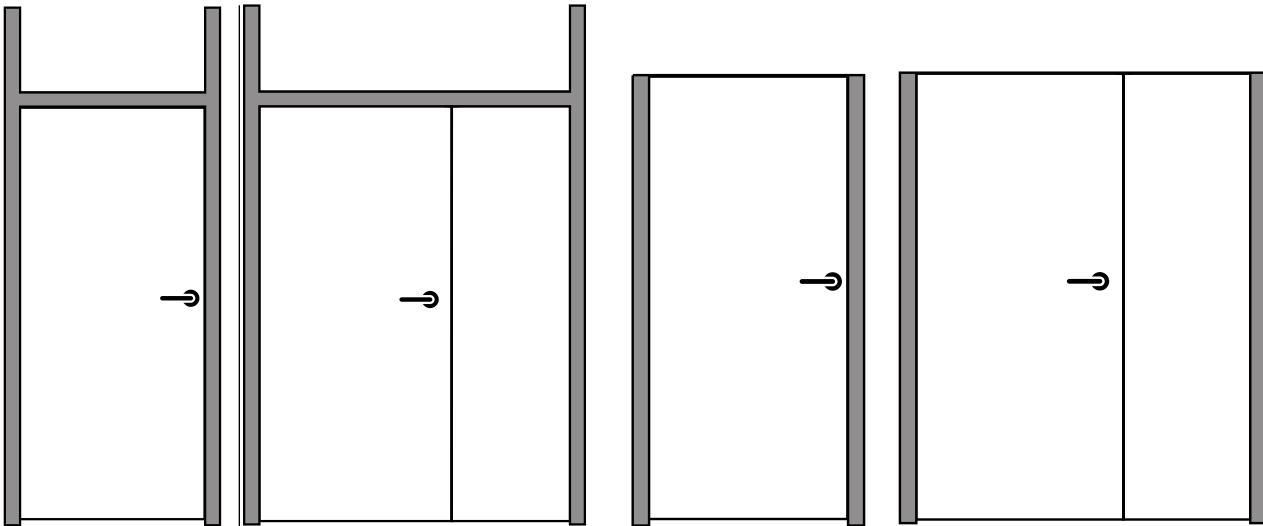
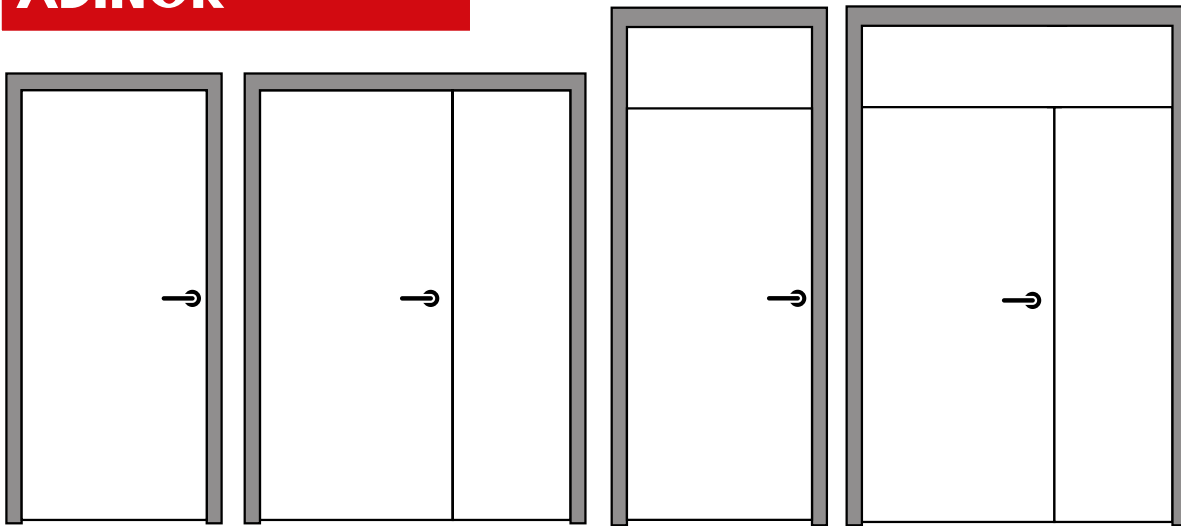

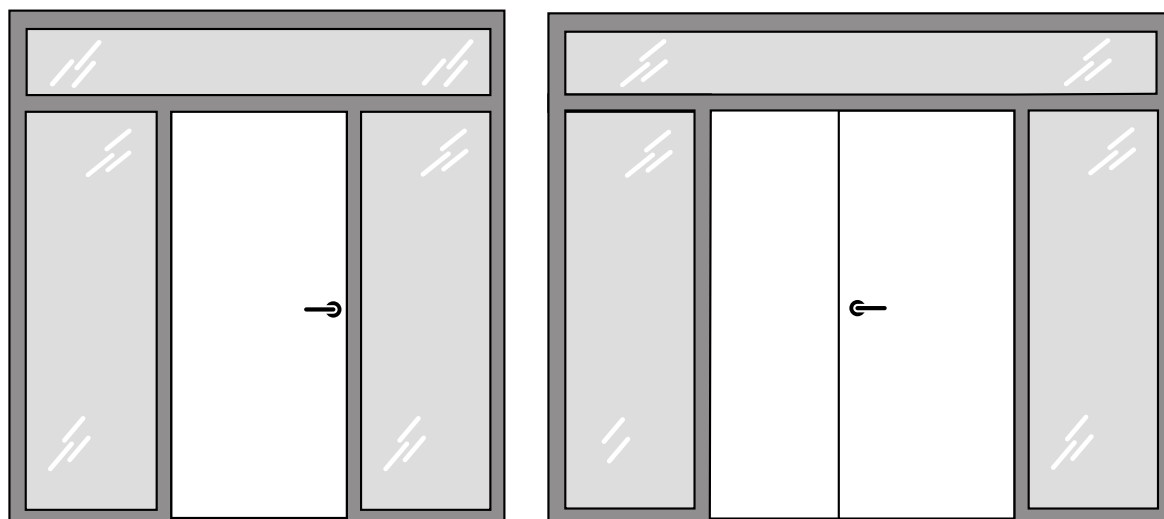
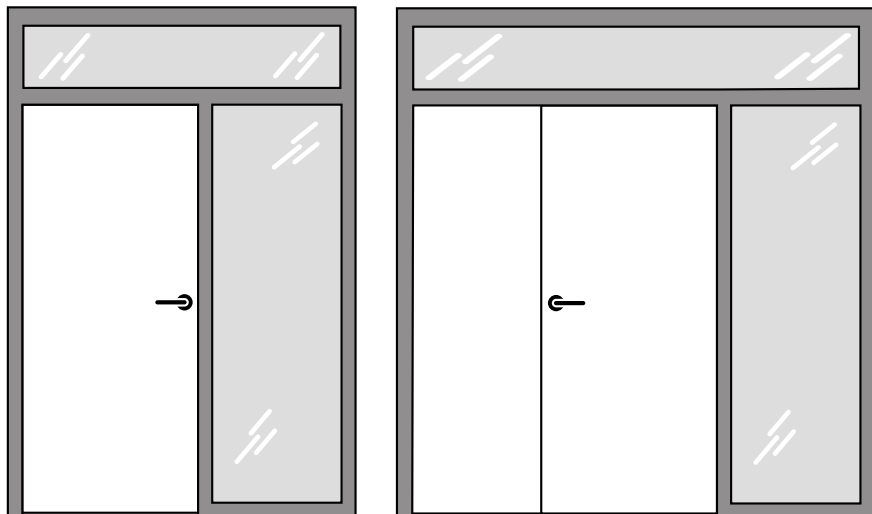
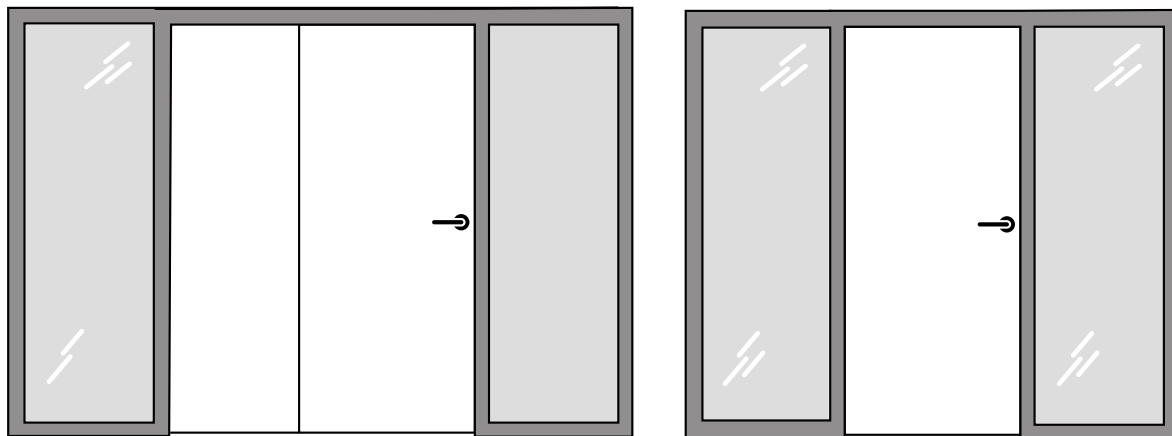
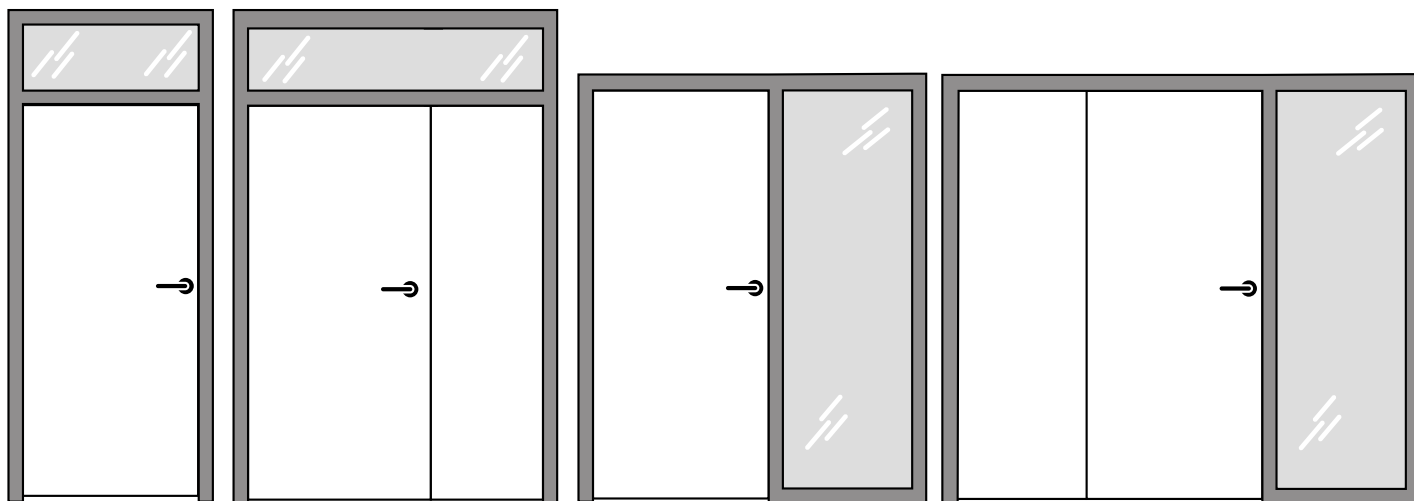

PUERTA ABATIBLE FOLDING DOOR ADINOR

MARCO PARA HOJA 40mm

40 mm ALUMINIUM FRAME

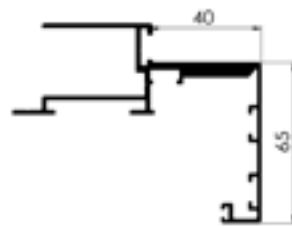

Calculo medida Puerta:
 Anchura Puerta = Anchura hueco luz obra - 60mm
 Altura Puerta = Altura hueco luz obra - 40mm

EXTENSIÓN "S", DISTANCIA 70-100mm

70-100mm EXTENSIBLE ALUMINIUM FRAME "S"

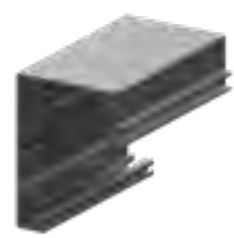
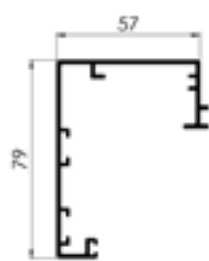
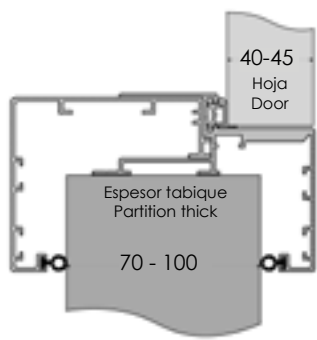

EXTENSIÓN "M", DISTANCIA 100-130mm

100-130mm EXTENSIBLE ALUMINIUM FRAME "M"

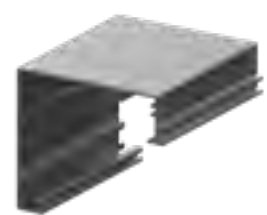
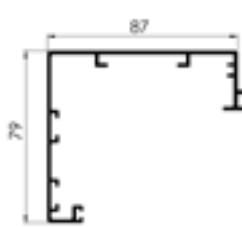
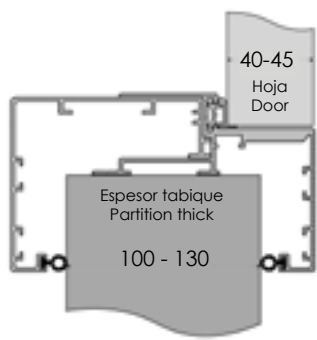

MARCO PARA HOJA 45mm

45 mm ALUMINIUM FRAME

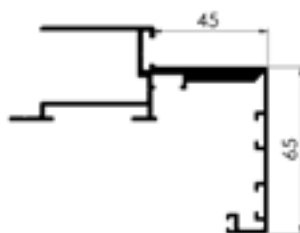

Door measurement calculation:
 Door width = Opening width - 60mm
 Door height = Opening height - 40mm

EXTENSIÓN "L", DISTANCIA 130-160mm

130-160mm EXTENSIBLE ALUMINIUM FRAME "L"

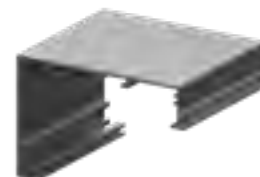
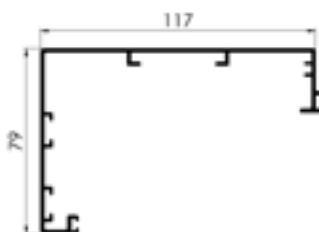
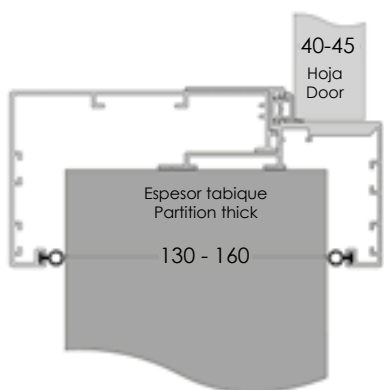

EXTENSIÓN XL, DISTANCIA 160-190mm

160-190mm EXTENSIBLE ALUMINIUM FRAME "XL"

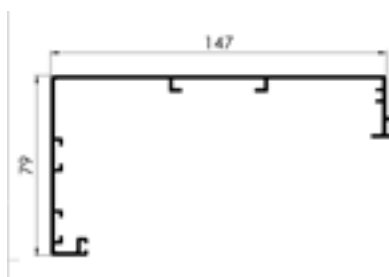
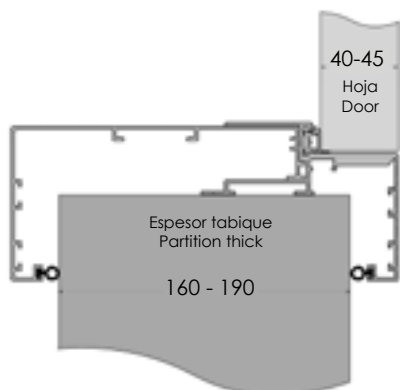

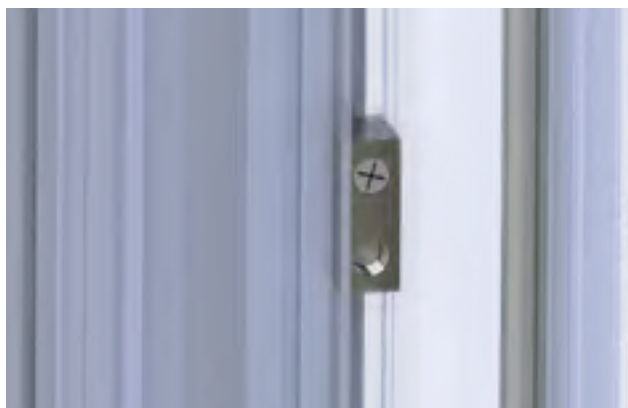
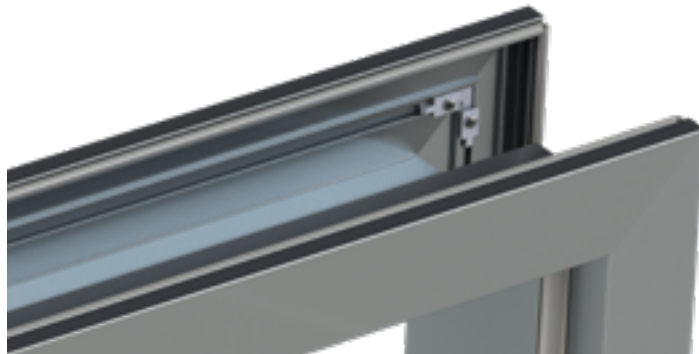



MARCO DE ALUMINIO EXTENSIBLE HOJA DE 40mm Y 45mm ANODIZADO PLATA MATE
40-45mm DOOR THICK NATURAL ANODIZED EXTENDABLE ALUMINIUM FRAME

MEDIDA MÁXIMA DE HOJA MAXIMUM WIDTH DOOR	S TABIQUE / PARTITION 70-100mm	M TABIQUE / PARTITION 100-130mm	L TABIQUE / PARTITION 130-160mm	XL TABIQUE / PARTITION 160-190mm
SIMPLE / SINGLE 92,5 x 2,11	ME.S.S921.APM	ME.M.S921.APM	ME.L.S921.APM	ME.X.S921.APM
SIMPLE / SINGLE 1,20 x 2,11	ME.S.S121.APM	ME.M.S121.APM	ME.L.S121.APM	ME.X.S121.APM
SIMPLE / SINGLE 92,5 x 2,40	ME.S.S924.APM	ME.M.S924.APM	ME.L.S924.APM	ME.X.S924.APM
SIMPLE / SINGLE 1,20 x 2,40	ME.S.S124.APM	ME.M.S124.APM	ME.L.S124.APM	ME.X.S124.APM
DOBLE / DOUBLE 1,80 x 2,11	ME.S.D121.APM	ME.M.D121.APM	ME.L.D121.APM	ME.X.D121.APM
DOBLE / DOUBLE 2,40 x 2,11	ME.S.D221.APM	ME.M.D221.APM	ME.L.D221.APM	ME.X.D221.APM
DOBLE / DOUBLE 1,80 x 2,40	ME.S.D124.APM	ME.M.D124.APM	ME.L.D124.APM	ME.X.D124.APM
DOBLE / DOUBLE 2,40 x 2,40	ME.S.D224.APM	ME.M.D224.APM	ME.L.D224.APM	ME.X.D224.APM

MARCO DE ALUMINIO EXTENSIBLE HOJA DE 40mm Y 45mm LACADO SEGÚN CARTA RAL
40-45mm DOOR THICK RAL COD. POWDER COATED EXTENDABLE ALUMINIUM FRAME

MEDIDA MÁXIMA DE HOJA MAXIMUM WIDTH DOOR	S TABIQUE / PARTITION 70-100mm	M TABIQUE / PARTITION 100-130mm	L TABIQUE / PARTITION 130-160mm	XL TABIQUE / PARTITION 160-190mm
SIMPLE / SINGLE 92,5 x 2,11	ME.S.S921.L	ME.M.S921.L	ME.L.S921.L	ME.X.S921.L
SIMPLE / SINGLE 1,20 x 2,11	ME.S.S121.L	ME.M.S121.L	ME.L.S121.L	ME.X.S121.L
SIMPLE / SINGLE 92,5 x 2,40	ME.S.S924.L	ME.M.S924.L	ME.L.S924.L	ME.X.S924.L
SIMPLE / SINGLE 1,20 x 2,40	ME.S.S124.L	ME.M.S124.L	ME.L.S124.L	ME.X.S124.L
DOBLE / DOUBLE 1,80 x 2,11	ME.S.D121.L	ME.M.D121.L	ME.L.D121.L	ME.X.D121.L
DOBLE / DOUBLE 2,40 x 2,11	ME.S.D221.L	ME.M.D221.L	ME.L.D221.L	ME.X.D221.L
DOBLE / DOUBLE 1,80 x 2,40	ME.S.D124.L	ME.M.D124.L	ME.L.D124.L	ME.X.D124.L
DOBLE / DOUBLE 2,40 x 2,40	ME.S.D224.L	ME.M.D224.L	ME.L.D224.L	ME.X.D224.L

MARCO DE ALUMINIO EXTENSIBLE HOJA DE 40mm Y 45mm RECHAPADO HPL
40-45mm DOOR THICK HPL COVERED EXTENDABLE ALUMINIUM FRAME

MEDIDA MÁXIMA DE HOJA MAXIMUM WIDTH DOOR	S TABIQUE / PARTITION 70-100mm	M TABIQUE / PARTITION 100-130mm	L TABIQUE / PARTITION 130-160mm	XL TABIQUE / PARTITION 160-190mm
SIMPLE / SINGLE 92,5 x 2,11	ME.S.S921.HPL	ME.M.S921.HPL	ME.L.S921.HPL	ME.X.S921.HPL
SIMPLE / SINGLE 1,20 x 2,11	ME.S.S121.HPL	ME.M.S121.HPL	ME.L.S121.HPL	ME.X.S121.HPL
SIMPLE / SINGLE 92,5 x 2,40	ME.S.S924.HPL	ME.M.S924.HPL	ME.L.S924.HPL	ME.X.S924.HPL
SIMPLE / SINGLE 1,20 x 2,40	ME.S.S124.HPL	ME.M.S124.HPL	ME.L.S124.HPL	ME.X.S124.HPL
DOBLE / DOUBLE 1,80 x 2,11	ME.S.D121.HPL	ME.M.D121.HPL	ME.L.D121.HPL	ME.X.D121.HPL
DOBLE / DOUBLE 2,40 x 2,11	ME.S.D221.HPL	ME.M.D221.HPL	ME.L.D221.HPL	ME.X.D221.HPL
DOBLE / DOUBLE 1,80 x 2,40	ME.S.D124.HPL	ME.M.D124.HPL	ME.L.D124.HPL	ME.X.D124.HPL
DOBLE / DOUBLE 2,40 x 2,40	ME.S.D224.HPL	ME.M.D224.HPL	ME.L.D224.HPL	ME.X.D224.HPL

MARCO DE ALUMINIO EXTENSIBLE HOJA DE 40mm Y 45mm RECHAPADO PVC EXTERIOR
40-45mm DOOR THICK PVC COVERED EXTENDABLE ALUMINIUM FRAME

MEDIDA MÁXIMA DE HOJA MAXIMUM WIDTH DOOR	S TABIQUE / PARTITION 70-100mm	M TABIQUE / PARTITION 100-130mm	L TABIQUE / PARTITION 130-160mm	XL TABIQUE / PARTITION 160-190mm
SIMPLE / SINGLE 92,5 x 2,11	ME.S.S921.PVC	ME.M.S921.PVC	ME.L.S921.PVC	ME.X.S921.PVC
SIMPLE / SINGLE 1,20 x 2,11	ME.S.S121.PVC	ME.M.S121.PVC	ME.L.S121.PVC	ME.X.S121.PVC
SIMPLE / SINGLE 92,5 x 2,40	ME.S.S924.PVC	ME.M.S924.PVC	ME.L.S924.PVC	ME.X.S924.PVC
SIMPLE / SINGLE 1,20 x 2,40	ME.S.S124.PVC	ME.M.S124.PVC	ME.L.S124.PVC	ME.X.S124.PVC
DOBLE / DOUBLE 1,80 x 2,11	ME.S.D121.PVC	ME.M.D121.PVC	ME.L.D121.PVC	ME.X.D121.PVC
DOBLE / DOUBLE 2,40 x 2,11	ME.S.D221.PVC	ME.M.D221.PVC	ME.L.D221.PVC	ME.X.D221.PVC
DOBLE / DOUBLE 1,80 x 2,40	ME.S.D124.PVC	ME.M.D124.PVC	ME.L.D124.PVC	ME.X.D124.PVC
DOBLE / DOUBLE 2,40 x 2,40	ME.S.D224.PVC	ME.M.D224.HPL	ME.L.D224.PVC	ME.X.D224.PVC

KIT MARCOS

FRAME SETS

ADINOR

LOS CERCOS SE SIRVEN DESMONTADOS, CORTADOS, MECANIZADOS Y EMPAQUETADOS EN CAJA

INFORMACIÓN SUMINISTRO KIT MARCOS:

LOS CERCOS PARA HOJA SIMPLE DE ALTURA 2,11m INCLUYEN 3 PERNIOS EN INOX + LAS ESCUADRAS, GOMAS Y NIVELADORES DE MARCO NECESARIOS PARA SU COLOCACIÓN.

LOS CERCOS PARA HOJA SIMPLE DE ALTURA 2,40m INCLUYEN 4 PERNIOS EN INOX + LAS ESCUADRAS, GOMAS Y NIVELADORES DE MARCO NECESARIOS PARA SU COLOCACIÓN.

LOS CERCOS PARA HOJA DOBLES DE ALTURA 2,11m INCLUYEN 6 PERNIOS EN INOX + LAS ESCUADRAS, GOMAS Y NIVELADORES DE MARCO NECESARIOS PARA SU COLOCACIÓN

LOS CERCOS PARA HOJA DOBLE DE ALTURA 2,40m INCLUYEN 8 PERNIOS EN INOX + LAS ESCUADRAS, GOMAS Y NIVELADORES DE MARCO NECESARIOS PARA SU COLOCACIÓN.

THE FRAMES ARE SERVED DISASSEMBLED, CUT, MACHINED AND PACKAGED IN A BOX

INFORMATION SUPPLY SET FRAMES:

THE FRAME FOR SINGLE DOOR OF 2.11m HEIGHT INCLUDES 3 STAINLESS HINGES + THE ALIGNMENT BRACKETS, GASKETS AND FRAME LEVELERS REQUIRED FOR THE INSTALATION

THE FRAME FOR DOUBLE DOOR OF 2.11m HEIGHT INCLUDES 6 STAINLESS STEEL HINGES + THE ALIGNMENT BRACKETS, GASKETS AND FRAME LEVELERS REQUIRED FOR THE INSTALATION

THE FRAMES ARE SERVED DISASSEMBLED, CUT, MACHINED AND PACKAGED IN A BOX MECANIZACIÓN CERRADERO STRIKE PLATE MACHINING

THE FRAME FOR SINGLE DOOR OF 2.40m HEIGHT INCLUDES 4 STAINLESS HINGES + THE ALIGNMENT BRACKETS, GASKETS AND FRAME LEVELERS REQUIRED FOR THE INSTALATION

THE FRAME FOR DOUBLE DOOR OF 2.40m HEIGHT INCLUDES 8 STAINLESS STEEL HINGES + THE ALIGNMENT BRACKETS, GASKETS AND FRAME LEVELERS REQUIRED FOR THE INSTALATION

MECANIZACIÓN CERRADERO STRIKE PLATE MACHINING

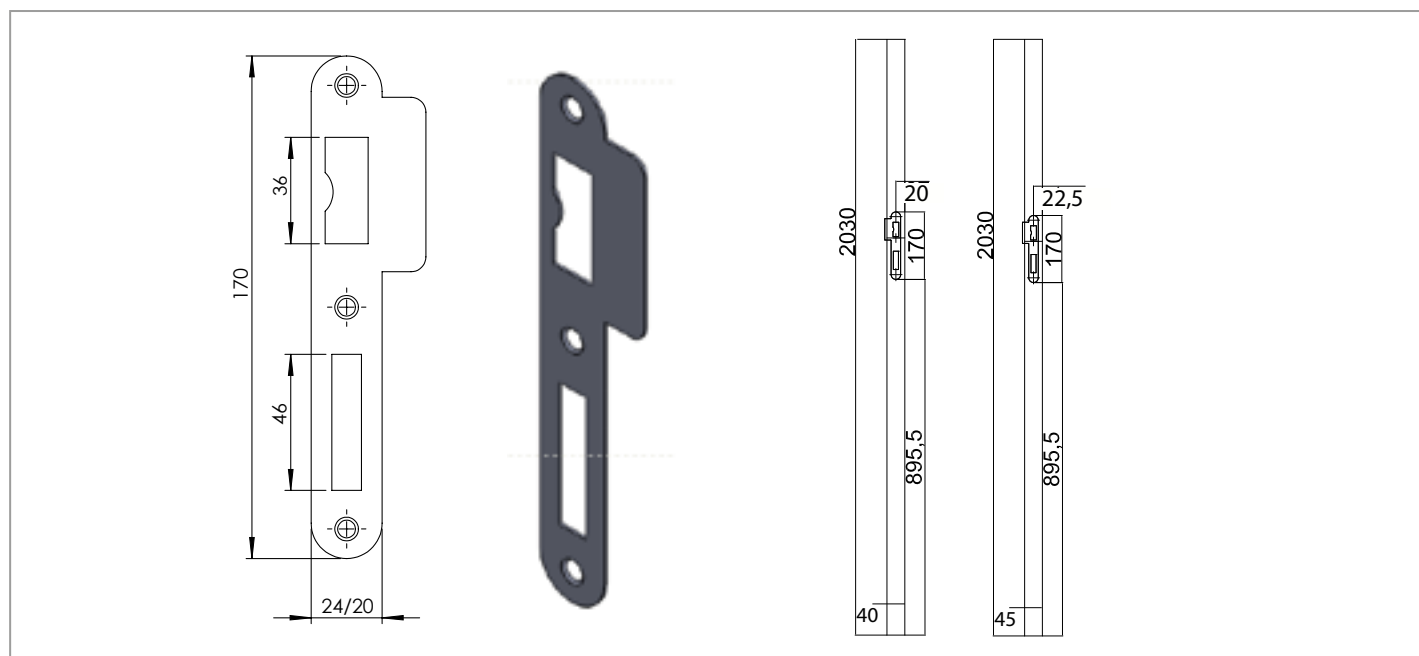

GOMA PVC MARCO ALUMINIO

PVC FRAME GASKET



REF.
ME.120

GOMA PVC ANTIRUIDO PUERTA

PVC ANTI-SHOCK GASKET



REF.
ME.110

ESCUADRA DE FIJACIÓN 40x40

40x40 INNER CONNECTION



REF.
ME.130

ESCUADRA UNION MONTAJE A INGLETE

ALIGNMENT FRAME BRACKET



REF.
ME700

NIVELADOR DE DISTANCIA

FRAME LEVELER



REF.
ME.150

BISAGRA INOX 100x86mm

100x86 SS HINGE

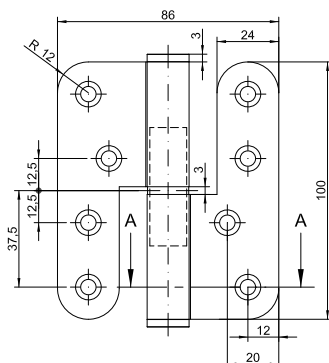

REF.
ME.BI.100X86

BISAGRA INOX 100x86mm

100x86 SS HINGE

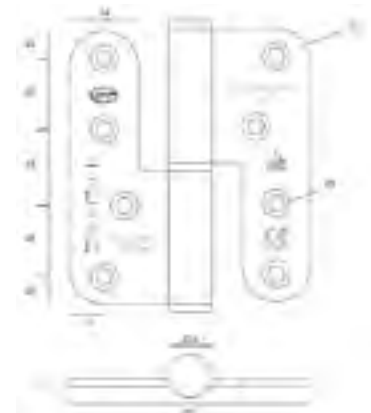

REF.
ME.BJ.100X86

BISAGRA INOX 90x65mm

90x65 SS HINGE

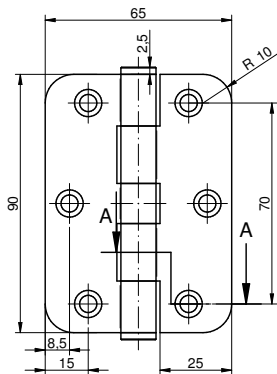

REF.

ME.BI.90X65

BISAGRA OCULTA BB

CONCEALED HINGE

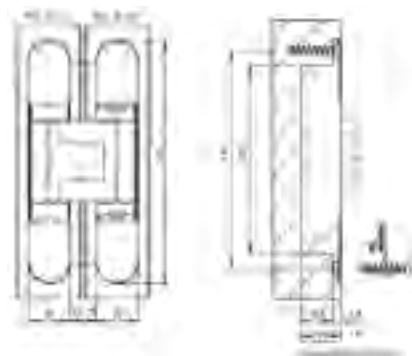

ACABADOS	REF.
NEGRO	MR.BB.N
BLANCO	MR.BB.B
CROMO SATINADO	MR.BB.CS

CERRADURA DIN VI

VI DIN LOCK

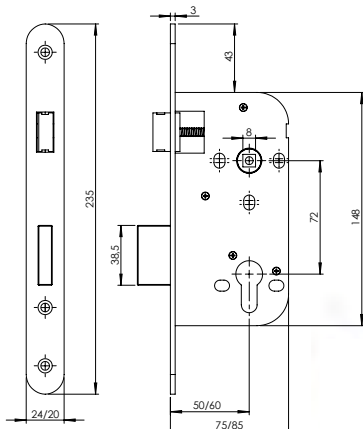

REF.

ME.CDIN.VI

CERRADURA DIN VD

VC DIN LOCK



REF.

ME.CDIN.VD

CERRADURA MAGNETICA CB CILINDRO

CYLINDER MAGNETIC LOCK (CB)

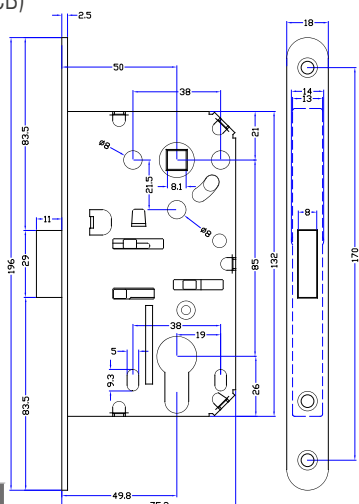

ACABADO

CROMO SATINADO

REF.

MR.CB.C.P

CERRADERO CRB

MAGNETIC STRIKE PLATE

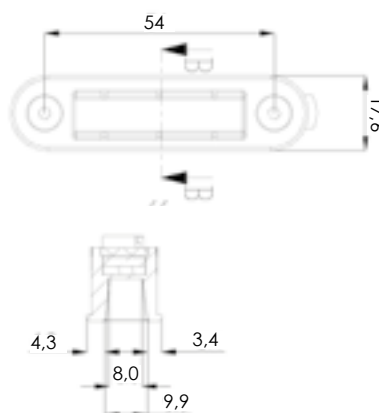

ACABADO

GRIS

REF.

MR.CRB.P

SISTEMA CORREDERO

SLIDING SYSTEM

ADINOR

MARCO EXTENSIBLE ALUMINIO PARA CORREDERA SOBRE PARED

EXTENSIBLE ALUMINIUM FRAME FOR SLIDING DOOR SYSTEM

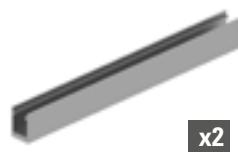
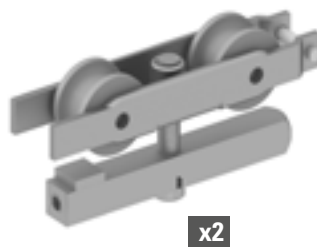
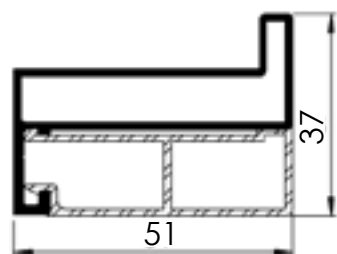
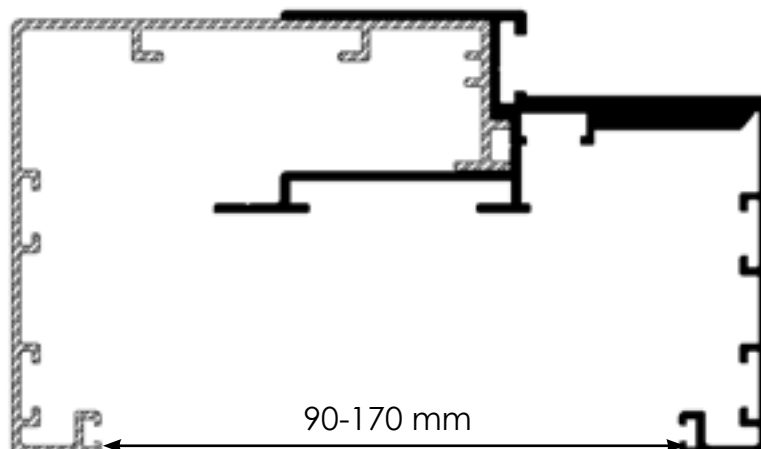
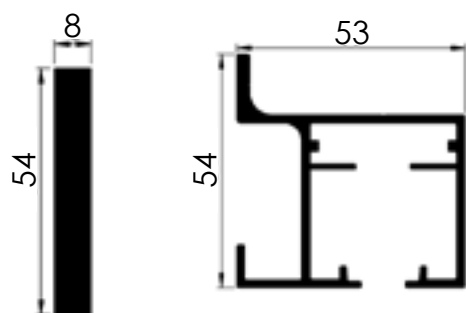

AMORTIGUADOR BIDIRECCIONAL

BIDIRECTIONAL SOFT-CLOSING SYSTEM



OPCIONAL / OPTIONAL

KG	REF.
60	SK.AMBID.60
80	SK.AMBID.80
100	SK.AMBID.100
120	SK.AMBID.120





PLATA MATE / NATURAL ANODICED

MEDIDA MÁXIMA DE HOJA MAXIMUM WIDTH DOOR	S TABIQUE / PARTITION 70-100mm	M TABIQUE / PARTITION 100-130mm	L TABIQUE / PARTITION 130-160mm	XL TABIQUE / PARTITION 160-190mm
SIMPLE / SINGLE 92,5 x 2,11	MEPCE.S921.PM	MEPCE.M921.PM	MEPCE.L921.PM	MEPCE.X921.PM
SIMPLE / SINGLE 1,20 x 2,11	MEPCE.S121.PM	MEPCE.M121.PM	MEPCE.L121.PM	MEPCE.X121.PM
SIMPLE / SINGLE 92,5 x 2,40	MEPCE.S924.PM	MEPCE.M924.PM	MEPCE.L924.PM	MEPCE.X924.PM
SIMPLE / SINGLE 1,20 x 2,40	MEPCE.S124.PM	MEPCE.M124.PM	MEPCE.L124.PM	MEPCE.X124.PM

LACADO RAL / RAL COATED

MEDIDA MÁXIMA DE HOJA MAXIMUM WIDTH DOOR	S TABIQUE / PARTITION 70-100mm	M TABIQUE / PARTITION 100-130mm	L TABIQUE / PARTITION 130-160mm	XL TABIQUE / PARTITION 160-190mm
SIMPLE / SINGLE 92,5 x 2,11	MEPCE.S921.L	MEPCE.M921.L	MEPCE.L921.L	MEPCE.X921.L
SIMPLE / SINGLE 1,20 x 2,11	MEPCE.S121.L	MEPCE.M121.L	MEPCE.L121.L	MEPCE.X121.L
SIMPLE / SINGLE 92,5 x 2,40	MEPCE.S924.L	MEPCE.M924.L	MEPCE.L924.L	MEPCE.X924.L
SIMPLE / SINGLE 1,20 x 2,40	MEPCE.S124.L	MEPCE.M124.L	MEPCE.L124.L	MEPCE.X124.L

TODOS LOS KITS DE MARCOS DE ALUMINIO PARA PUERTA CORREDERA SOBRE PARED SE SUMINISTRAN CON LOS MARCOS PARA FORRAR LOS TABIQUES, GUÍA, CARROS Y MARCO DE CIERRE.

OPCIONALMENTE SE PODRÁ PONER AMORTIGUADOR DE CIERRE BIDIRECCIONAL. (amortiguación tanto en la apertura como en el cierre)

ALL THE ALUMINIUM FRAME SETS FOR SLIDING DOOR ARE SUPPLIED WITH ALL THE NECESSARY ELEMENTS SUCH US: TRACK, ROLLERS, ALUMINIUM FRAMES, DOOR STOPPER FRAME...

BIDIRECCIONAL SOFT CLOSING SYSTEM COULD BE SUPPLIED. (opening soft and close soft).

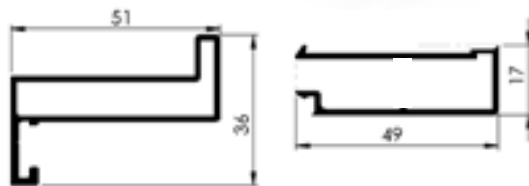
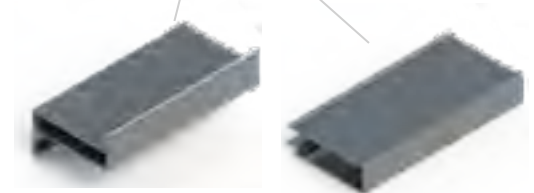

MARCO EXTENSIBLE ALUMINIO PARA ARMAZÓN

EXTENSIBLE ALUMINIUM FRAME FOR SLIDING STRUCTURE FRAME

HOJA SIMPLE
SINGLE DOOR FRAME



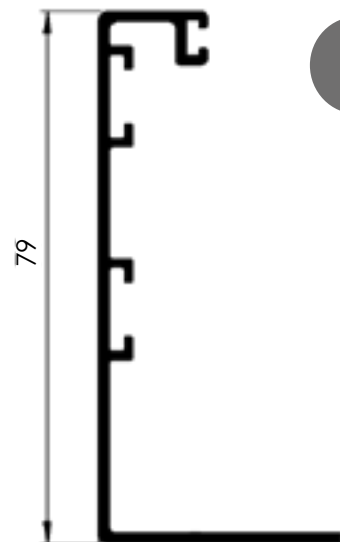
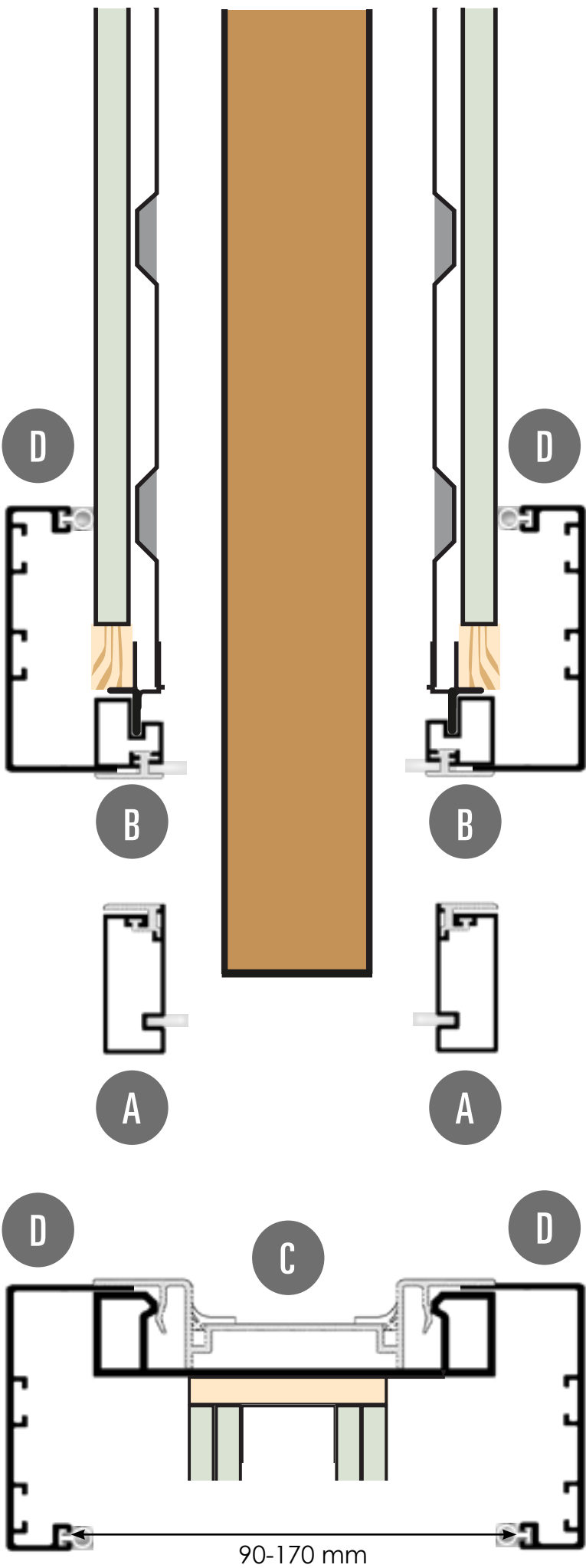

D

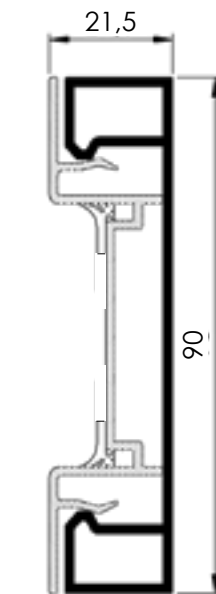

C

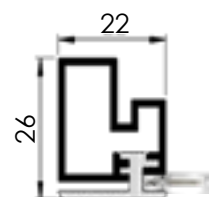

B

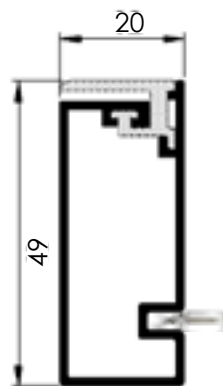

A

HOJA DOBLE
DOUBLE DOOR FRAME

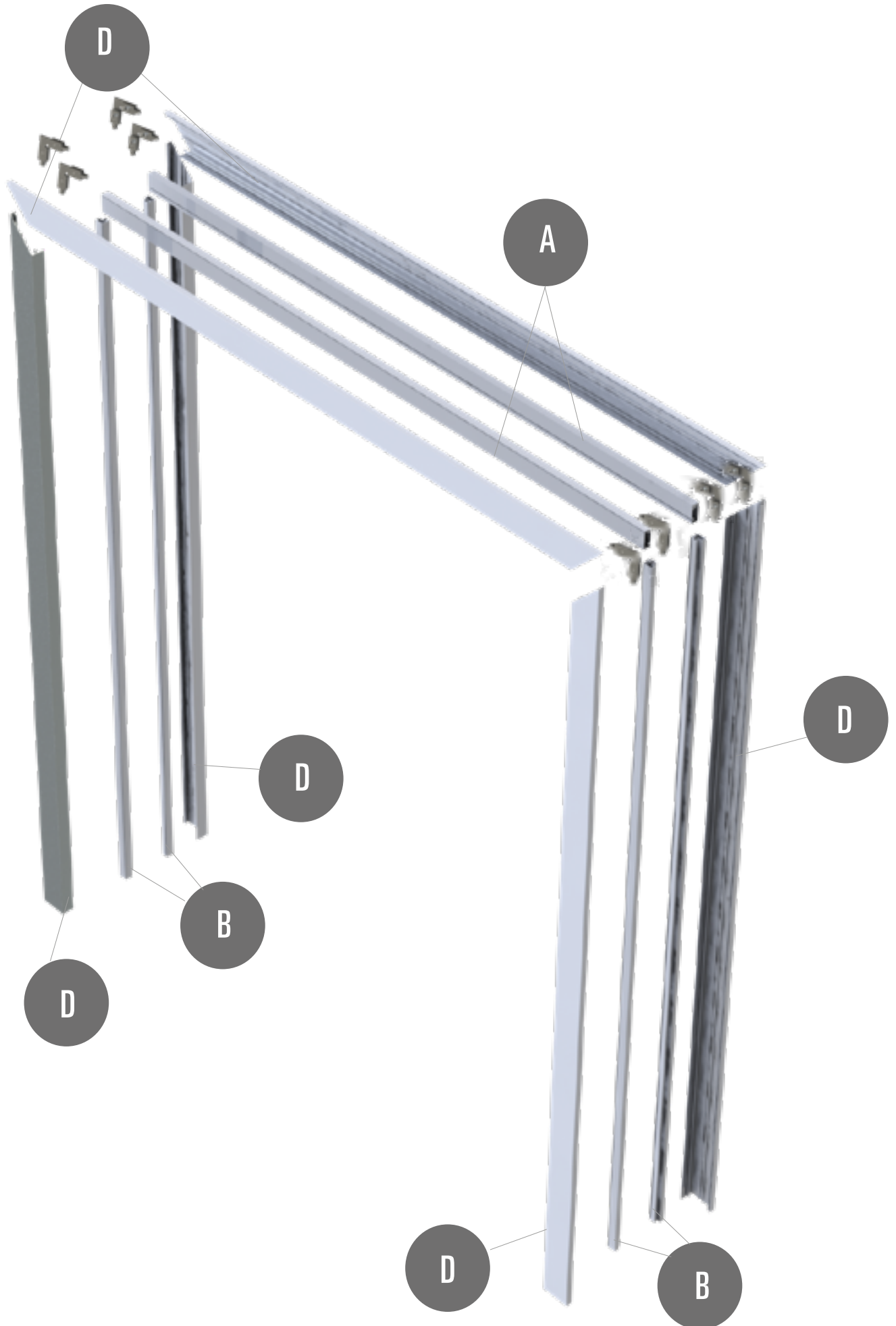

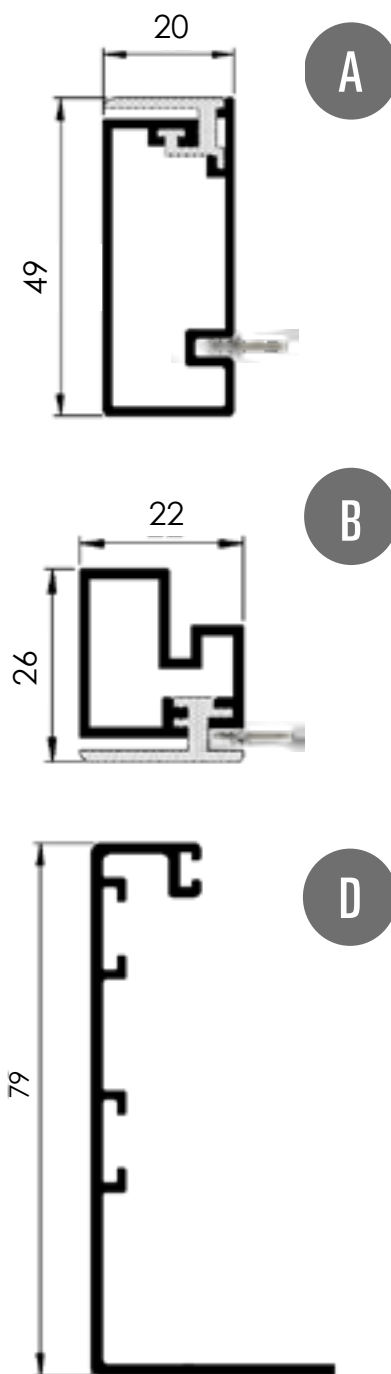
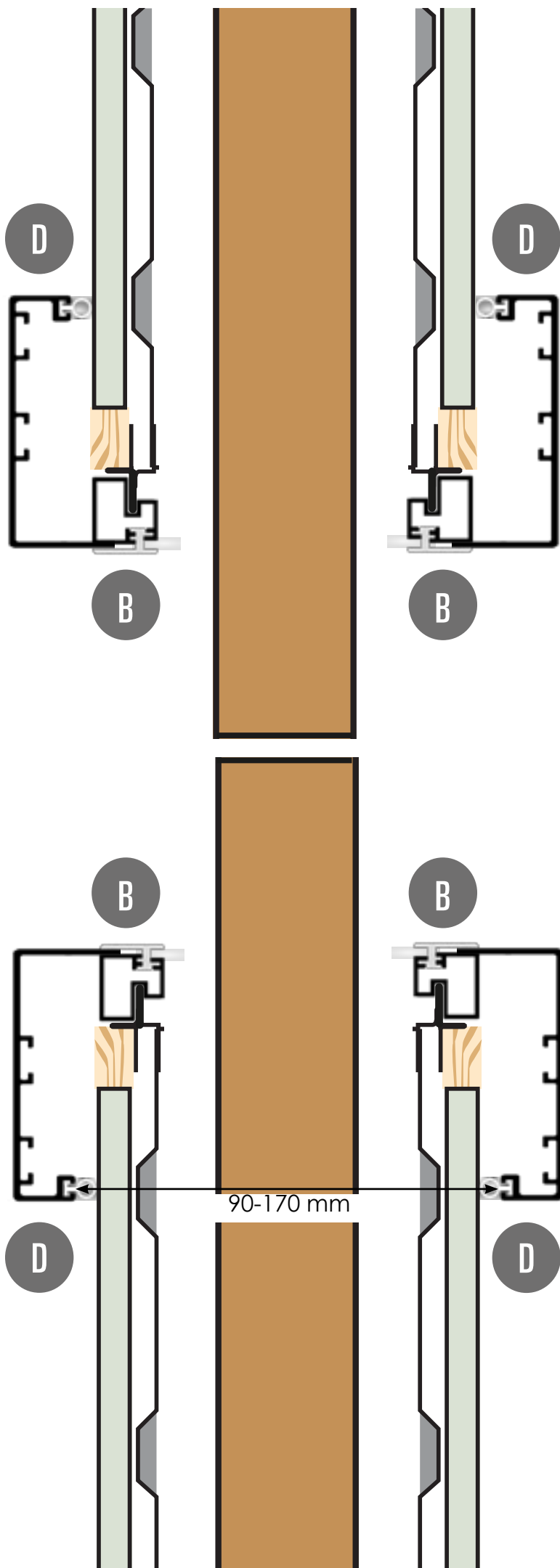

ALTURA DE HOJA 203cm / 203 cm DOOR HEIGHT

ANODIZADO P.MATE NATURAL ANODIZED	LACADO RAL RAL COATED	PUERTA DOOR	LUZ DE PASO CLEARANCE WIDTH	ANCHURA TABIQUE PARTITION WIDTH
MC.20PS.9.13	MC.20LS.9.13	SIMPLE / SINGLE	60 - 90 cm	90 - 130 cm
MC.20PS.9.17	MC.20LS.9.17	SIMPLE / SINGLE	60 - 90 cm	130 - 170 cm
MC.20PS.12.13	MC.20LS.12.13	SIMPLE / SINGLE	90 - 120 cm	90 - 130 cm
MC.20PS.12.17	MC.20LS.12.17	SIMPLE / SINGLE	90 - 120 cm	130 - 170 cm
MC.20PD.16.13	MC.20LD.16.13	DOBLE /DOUBLE	120 - 160 cm	90 - 130 cm
MC.20PD.16.17	MC.20LD.16.17	DOBLE /DOUBLE	120 - 160 cm	130 - 170 cm
MC.20PD.20.13	MC.20LD.20.13	DOBLE /DOUBLE	160 - 200 cm	90 - 130 cm
MC.20PD.20.17	MC.20LD.20.17	DOBLE /DOUBLE	160 - 200 cm	130 - 170 cm

ALTURA DE HOJA 211cm / 211 cm DOOR HEIGHT

ANODIZADO P.MATE NATURAL ANODIZED	LACADO RAL RAL COATED	PUERTA DOOR	LUZ DE PASO CLEARANCE WIDTH	ANCHURA TABIQUE PARTITION WIDTH
MC.21PS.9.13	MC.21LS.9.13	SIMPLE / SINGLE	60 - 90 cm	90 - 130 cm
MC.21PS.9.17	MC.21LS.9.17	SIMPLE / SINGLE	60 - 90 cm	130 - 170 cm
MC.21PS.12.13	MC.21LS.12.13	SIMPLE / SINGLE	90 - 120 cm	90 - 130 cm
MC.21PS.12.17	MC.21LS.12.17	SIMPLE / SINGLE	90 - 120 cm	130 - 170 cm
MC.21PD.16.13	MC.21LD.16.13	DOBLE /DOUBLE	120 - 160 cm	90 - 130 cm
MC.21PD.16.17	MC.21LD.16.17	DOBLE /DOUBLE	120 - 160 cm	130 - 170 cm
MC.21PD.20.13	MC.21LD.20.13	DOBLE /DOUBLE	160 - 200 cm	90 - 130 cm
MC.21PD.20.17	MC.21LD.20.17	DOBLE /DOUBLE	160 - 200 cm	130 - 170 cm

MEDIDAS ESPECIALES CONSULTAR
SPECIAL MEASURES UNDER REQUEST (MCE)

INFORMACIÓN SUMINISTRO KIT MARCOS:

TODOS LOS KITS PARA ARMAZON SE SUMINISTRAN CON LOS PERFILES VERTICALES MÁS LARGOS PARA PODER AJUSTAR EN OBRA.

LA MEDIDA ACE ES LA QUE NOS DETERMINARÁ LA LONGITUD DEL CABECERO

AEC = ANCHURA HUECO LIBRE SIN MOLDURAS DE ALUMINIO

EL MARCO DE ALUMINIO PUEDE UTILIZARSE INDISTINTAMENTE PARA PAREDES DE REVOCO Y CARTON YESO.

INFORMATION SUPPLY SET FRAMES:

ALL SETS OF ALUMINION FRAME ARE SUPPLIED WITH LONGER VERTICAL PROFILES SO IT CAN BE ADJUSTED ON SITE.

THE ACE MEASURE IS THE ONE THAT WILL DETERMINE US THE INNER WIDTH OF THE ALUMINIUM FRAME

AEC = OPEN WIDTH WITHOUT ALUMINIUM FRAME.

THE ALUMINIUM FRAME IT CAN BE USE FOR PLASTERBOARD WALLS AND MASONRY .

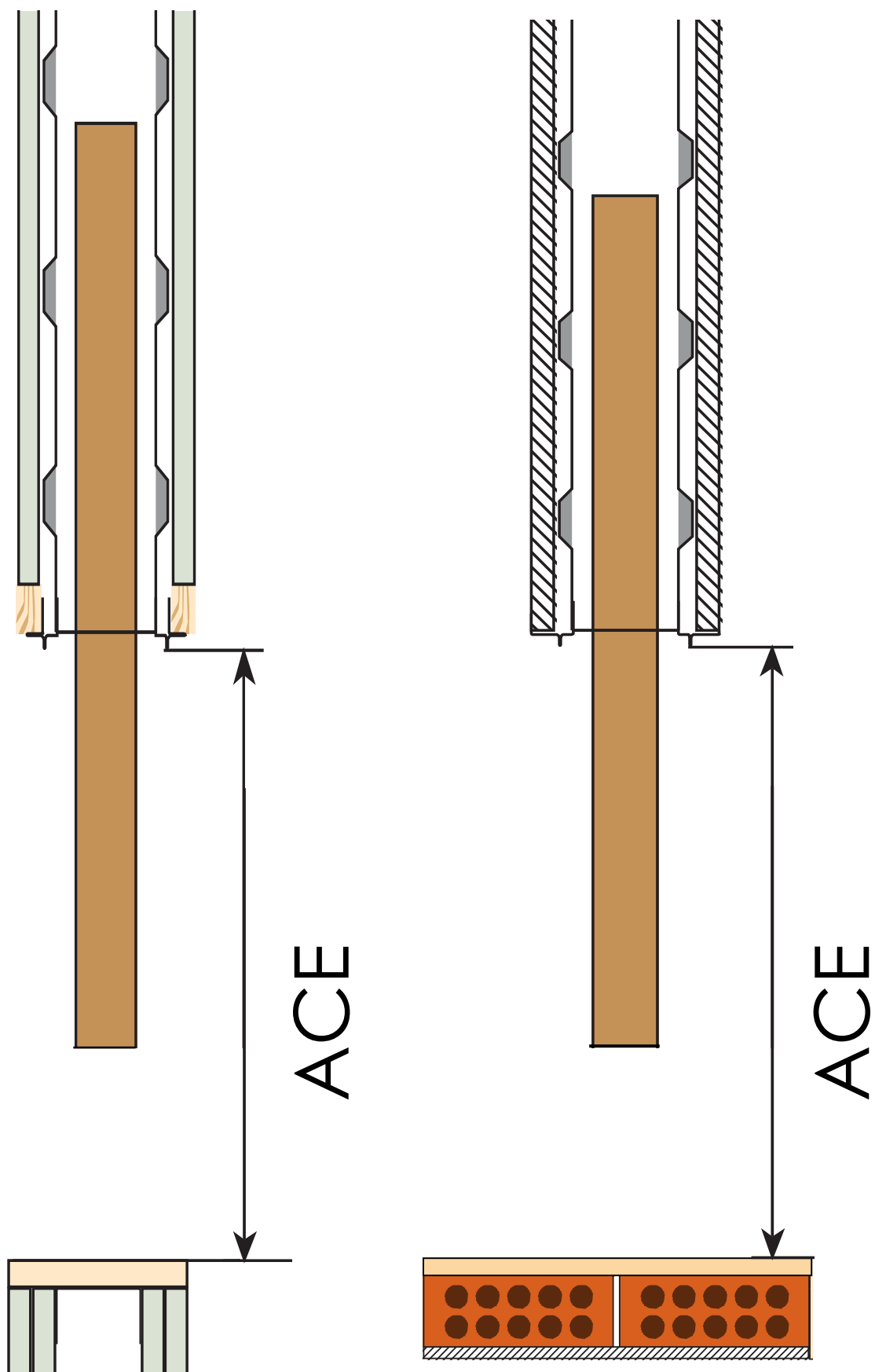

ACE = ANCHURA HUECO LIBRE SIN MOLDURAS DE ALUMINIO
AEC = OPEN WIDTH WITHOUT ALUMINUM FRAME.



PUERTA VAIVÉN REVOLVING DOOR

ADINOR

PUERTA VAIVEN

REVOLVING DOOR

PERFIL U PARA BISAGRA VAIVÉN

U ALUMINIUM PROFILE FOR REVOLVING DOOR

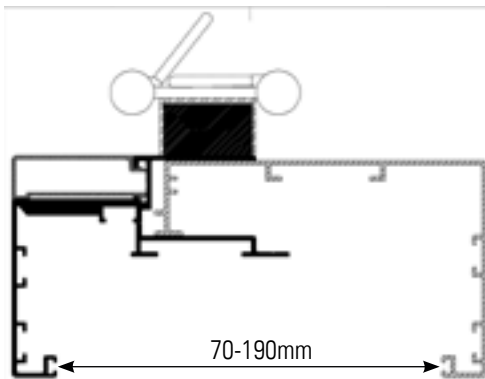
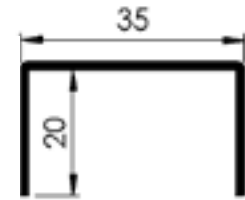
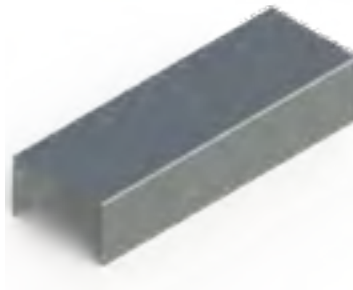

PLATA MATE / NATURAL ANODICED

MEDIDA MÁXIMA DE HOJA MAXIMUM WIDTH DOOR	S TABIQUE / PARTITION 70-100mm	M TABIQUE / PARTITION 100-130mm	L TABIQUE / PARTITION 130-160mm	XL TABIQUE / PARTITION 160-190mm
SIMPLE / SINGLE 92,5 x 2,11	ME.PV.S921.PM	ME.PV.M921.PM	ME.PV.L921.PM	ME.PV.X921.PM
SIMPLE / SINGLE 1,20 x 2,11	ME.PV.S121.PM	ME.PV.M121.PM	ME.PV.L121.PM	ME.PV.X121.PM
SIMPLE / SINGLE 92,5 x 2,40	ME.PV.S924.PM	ME.PV.M924.PM	ME.PV.L924.PM	ME.PV.X924.PM
SIMPLE / SINGLE 1,20 x 2,40	ME.PV.S124.PM	ME.PV.M124.PM	ME.PV.L124.PM	ME.PV.X124.PM

LACADO RAL / RAL COATED

MEDIDA MÁXIMA DE HOJA MAXIMUM WIDTH DOOR	S TABIQUE / PARTITION 70-100mm	M TABIQUE / PARTITION 100-130mm	L TABIQUE / PARTITION 130-160mm	XL TABIQUE / PARTITION 160-190mm
SIMPLE / SINGLE 92,5 x 2,11	ME.PV.S921.L	ME.PV.M921.L	ME.PV.L921.L	ME.PV.X921.L
SIMPLE / SINGLE 1,20 x 2,11	ME.PV.S121.L	ME.PV.M121.L	ME.PV.L121.L	ME.PV.X121.L
SIMPLE / SINGLE 92,5 x 2,40	ME.PV.S924.L	ME.PV.M924.L	ME.PV.L924.L	ME.PV.X924.L
SIMPLE / SINGLE 1,20 x 2,40	ME.PV.S124.L	ME.PV.M124.L	ME.PV.L124.L	ME.PV.X124.L



**MARCO
EMPLOMADO
LEAD REINFORCED
ALUMINIUM FRAME
ADINOR**

MARCO DE ALUMINIO REFORZADO CON PLOMO ESPECIAL PARA RADIOLOGÍA

LEAD REINFORCED ALUMINIUM FRAME FOR RADIOLOGY ROOMS

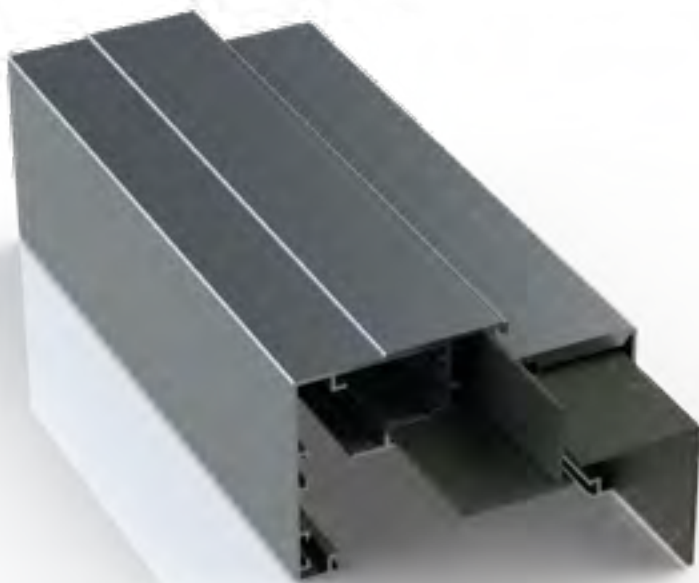
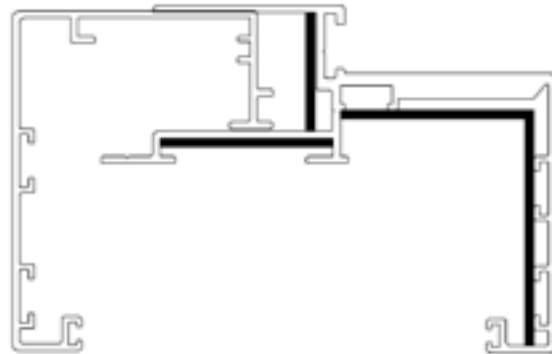

CARACTERÍSTICAS CHARACTERISTICS

Perfil de aluminio reforzado con placas de plomo estandar de 2mm de grosor.

Diseñado especialmente para zonas de radiología (rayos X).

El marco se puede adaptar a distintos anchos de tabique desde 70 hasta 190mm.

El marco de aluminio puede tener acabado anodizado plata mate o lacado RAL.

Calculo medida Puerta:

Anchura Puerta = Anchura hueco luz obra - 60mm

Altura Puerta = Altura hueco luz obra - 40mm

Aluminium frame reinforced with a 2 mm lead.

Specially designed for radiology areas (X-Ray rooms)

The extensible aluminium frame can be adapted to from 70 to 190mm.

The frames finishings could be natural anodized or Ral powder coated.

Door measurement calculation:

Door width = Opening width - 60mm

Door height = Opening height - 40mm

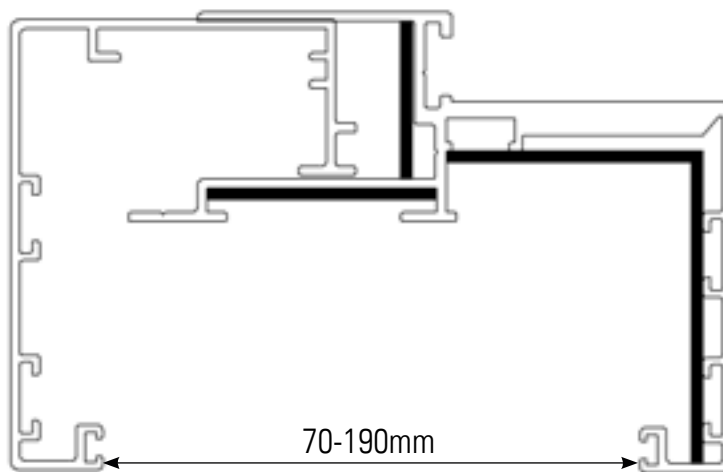

MARCO DE ALUMINIO EXTENSIBLE HOJA DE 40mm Y 45mm REFORZADO CON PLOMO ANODIZADO PLATA MATE
40-45mm DOOR THICK NATURAL ANODIZED EXTENDABLE ALUMINIUM FRAME LEAD REINFORCED

MEDIDA MÁXIMA DE HOJA MAXIMUM WIDTH DOOR	S TABIQUE / PARTITION 70-100mm	M TABIQUE / PARTITION 100-130mm	L TABIQUE / PARTITION 130-160mm	XL TABIQUE / PARTITION 160-190mm
SIMPLE / SINGLE 92,5 x 2,11	MEP.S.921.APM	MEP.M.921.APM	MEP.L.921.APM	MEPX.921.APM
SIMPLE / SINGLE 1,20 x 2,11	MEP.S.121.APM	MEP.M.121.APM	MEP.L.121.APM	MEPX.121.APM
SIMPLE / SINGLE 92,5 x 2,40	MEP.S.924.APM	MEP.M.924.APM	MEP.L.924.APM	MEPX.924.APM
SIMPLE / SINGLE 1,20 x 2,40	MEP.S.124.APM	MEP.M.124.APM	MEP.L.124.APM	MEPX.124.APM

MARCO DE ALUMINIO EXTENSIBLE HOJA DE 40mm Y 45mm REFORZADO CON PLOMO LACADO SEGÚN CARTA RAL
40-45mm DOOR THICK RAL COD. POWDER COATED EXTENDABLE ALUMINIUM FRAME LEAD REINFORCED

MEDIDA MÁXIMA DE HOJA MAXIMUM WIDTH DOOR	S TABIQUE / PARTITION 70-100mm	M TABIQUE / PARTITION 100-130mm	L TABIQUE / PARTITION 130-160mm	XL TABIQUE / PARTITION 160-190mm
SIMPLE / SINGLE 92,5 x 2,11	MEP.S.921.L	MEP.M.921.L	MEP.L.921.L	MEPX.921.L
SIMPLE / SINGLE 1,20 x 2,11	MEP.S.121.L	MEP.M.121.L	MEP.L.121.L	MEPX.121.L
SIMPLE / SINGLE 92,5 x 2,40	MEP.S.924.L	MEP.M.924.L	MEP.L.924.L	MEPX.924.L
SIMPLE / SINGLE 1,20 x 2,40	MEP.S.124.L	MEP.M.124.L	MEP.L.124.L	MEPX.124.L

DIVISIONES HORIZONTALES

HORIZONTAL DOOR DIVISION

ADINOR

DIVISIONES HORIZONTALES PARA PUERTAS CON MARCOS DE ALUMINIO

HORIZONTAL PARTITION ALUMINIUM FRAME



ANODIZADO PLATA MATE / NATURAL ANODICED

TABIQUE / PARTITION	REF
"S" TABIQUE / PARTITION 70-100mm	ME.DH.APM.S
"M" TABIQUE / PARTITION 100-130mm	ME.DH.APM.M
"L" TABIQUE / PARTITION 130-160mm	ME.DH.APM.L
"XL" TABIQUE / PARTITION 160-190mm	ME.DH.APM.XL

LACADO CARTA RAL / RAL COD. POWDER COATED

TABIQUE / PARTITION	REF
"S" TABIQUE / PARTITION 70-100mm	ME.DH.L.S
"M" TABIQUE / PARTITION 100-130mm	ME.DH.L.M
"L" TABIQUE / PARTITION 130-160mm	ME.DH.L.L
"XL" TABIQUE / PARTITION 160-190mm	ME.DH.L.XL

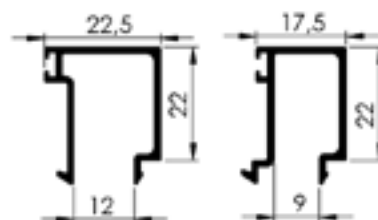
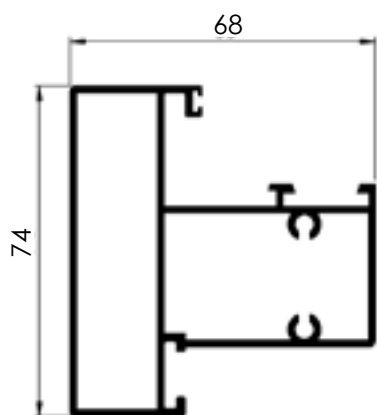
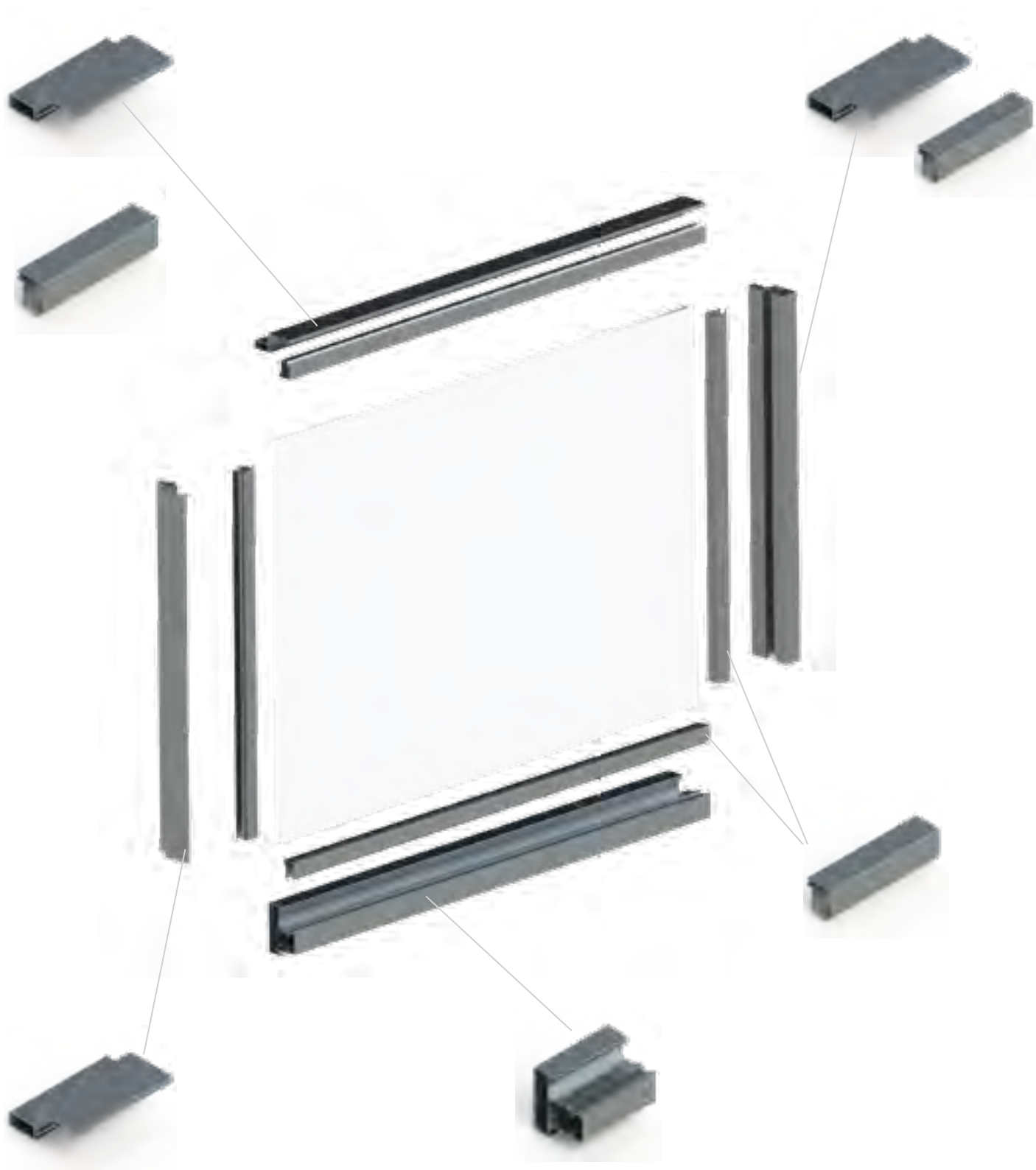

**DIVISIONES
VERTICALES**

**VERTICAL DOOR
DIVISION**

ADINOR

DIVISIONES VERTICALES PARA PUERTAS CON MARCOS DE ALUMINIO

VERTICAL PARTITION ALUMINIUM FRAME



ANODIZADO PLATA MATE / NATURAL ANODICED

TABIQUE / PARTITION	REF.
"S" TABIQUE / PARTITION 70-100mm	ME.MF.APM.S
"M" TABIQUE / PARTITION 100-130mm	ME.MF.APM.M
"L" TABIQUE / PARTITION 130-160mm	ME.MF.APM.L
"XL" TABIQUE / PARTITION 160-190mm	ME.MF.APM.XL

LACADO CARTA RAL / RAL COD. POWDER COATED

TABIQUE / PARTITION	REF.
"S" TABIQUE / PARTITION 70-100mm	ME.MF.L.S
"M" TABIQUE / PARTITION 100-130mm	ME.MF.L.M
"L" TABIQUE / PARTITION 130-160mm	ME.MF.L.L
"XL" TABIQUE / PARTITION 160-190mm	ME.MF.L.XL

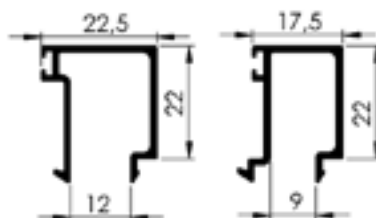
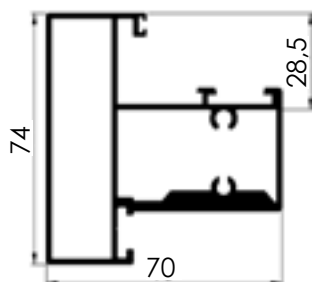
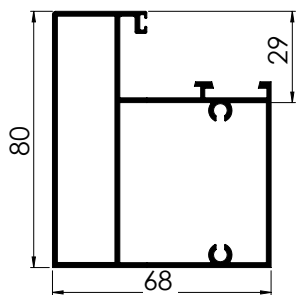



PUERTAS PA

PUERTA ABATIBLE PIVOTANTE

PA PIVOT DOOR

320

SISTEMA PUERTA CORREDERA

SLIDING DOOR SYSTEM

326

30X30 SISTEMA ABATIBLE Y FIJO

30X30 ALUMINIUM SYSTEM

343

SISTEMA PLEGABLE PIVOTANTE

BIFOLDING PIVOT SYSTEM

353





PUERTA ABATIBLE PIVOTANTE PA PIVOT DOOR

ADINOR

SISTEMA DE PUERTA ABATIBLE PIVOTANTE PIVOT FOLDING DOOR SYSTEM

OPCIONES DE INSTALACIÓN INSTALLATION OPTIONS



KIT PUERTA ALUMINIO ABATIBLE PIVOTANTE ALUMINIUM PIVOT DOOR SET

ACABADOS DISPONIBLES FINISHINGS



Blanco Mate RAL 9003
Mat White RAL 9003



Negro Mate
Mat Black



Moka
Moka



Plata Mate
Natural Anodized



Roble Natural
Oak (Natural veneer)

ACABADOS	FINISHINGS	DERECHA / RIGHT	IZQUIERDA / LEFT
LACADOS	COATED	REF.	REF.
Blanco Mate RAL9003	Mat White RAL 9003	PAP.D.L.BM03	PAPI.L.BM03
Negro Mate	Mat Black	PAP.D.L.NM	PAPI.L.NM
Moka	Moka	PAP.D.L.MK	PAPI.L.MK
ANODIZADOS	ANODIZED	REF.	REF.
Plata Mate	Natural Anodized	PAP.D.A.PM	PAPI.A.PM
MADERA	NATURAL WOOD	REF.	REF.
Roble Natural	Oak	PAP.D.C.RB	PAPI.C.RB

ELEMENTOS DEL KIT

SET ELEMENTS

Perfil vertical
Vertical profile
2 x 2,7m

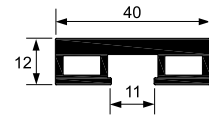

Perfil horizontal
Horizontal profile
2 x 1,5m

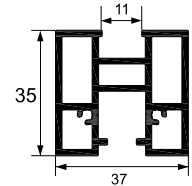

Perfil reductor para vidrio 8mm
8mm transparent gasket
2 x 2,7m
2 x 1,5m

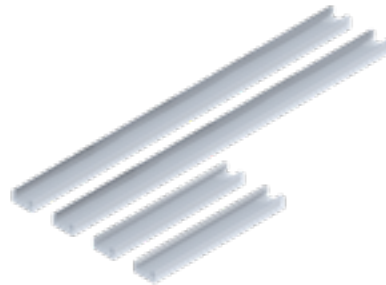

Perfil reductor para vidrio 6mm
6mm transparent gasket
2 x 2,7m
2 x 1,5m

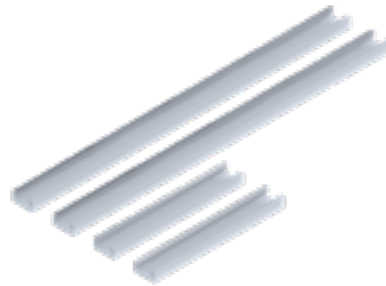

Tornillos
Screws
x 8



Bisagra Pivoteante
Pivot hinge
x 1



Plantilla
Template
x 1



Brocas
Drills



CERRADURA + EMBELLECEDOR

LOCK + COVERS

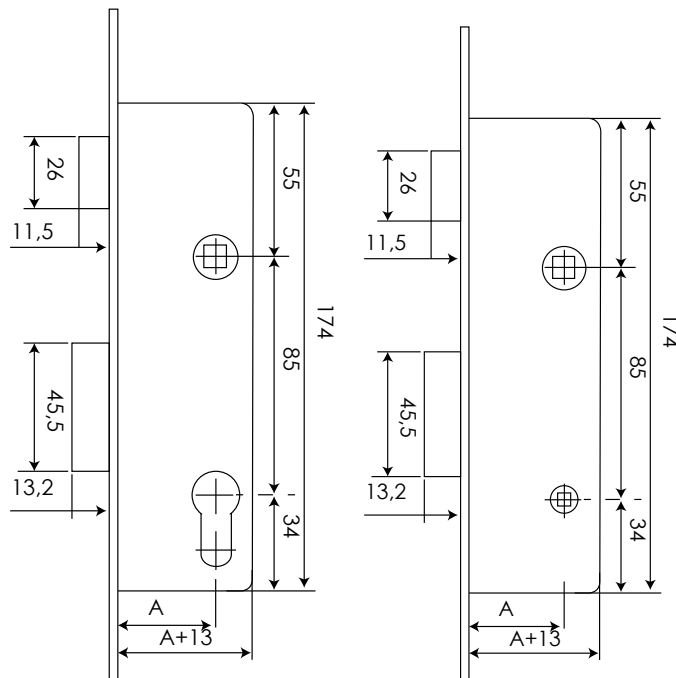

ACABADOS	FINISHINGS	DESCRIPCION / DESCRIPTION	REF.
Blanco Mate RAL9003	Matt White RAL9003	Con cilindro / With cylinder	PAPCC.L.BM03
		Sin cilindro / Without cylinder	PAPCSC.L.BM03
		Con condena / With WC lock	PAPCWC.L.BM03
Negro Mate RAL9003	Mat Black RAL9003	Con cilindro / With cylinder	PAPCC.L.NM
		Sin cilindro / Without cylinder	PAPCSC.L.NM
		Con condena / With WC lock	PAPCWC.L.NM
Moka	Moka	Con cilindro / With cylinder	PAPCC.L.MK
		Sin cilindro / Without cylinder	PAPCSC.L.MK
		Con condena / With WC lock	PAPCWC.L.MK
Plata Mate	Natural Anodized	Con cilindro / With cylinder	PAPCC.A.PM
		Sin cilindro / Without cylinder	PAPCSC.A.PM
		Con condena / With WC lock	PAPCWC.A.PM

BISAGRA PIVOTANTE

PIVOT HINGE



DESCRIP	REF.
Derecha / Right	PA.D.300
Izquierda / Left	PA.IZ.300

CIERRE MAGNETICO

MAGNETIC CLOSING

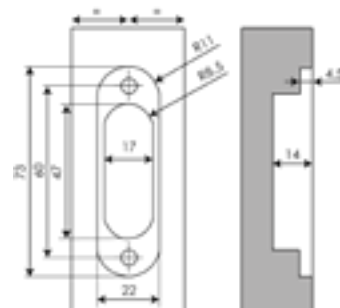

REF.
PA.250

MANETA TOULON

TOULON HANDLE

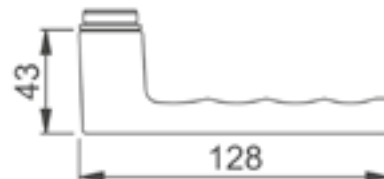
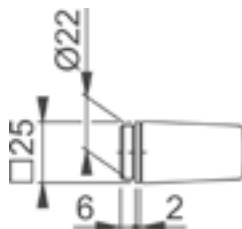

ACABADOS	FINISHINGS	REF.
Blanco	White	PAPMTL.B
Negro	Black	PAPMTL.N

MANETA AMSTERDAM

AMSTERDAM HANDLE

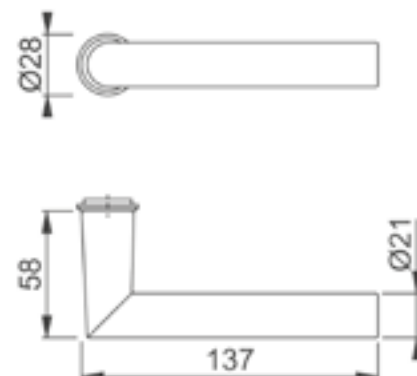
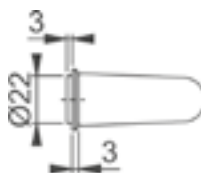

ACABADOS	FINISHINGS	REF.
Blanco	White	PAPMA.L.B
Negro	Black	PAPMA.L.N



SISTEMA DE PUERTA CORREDERA

SLIDING DOOR SYSTEM















SISTEMA DE PUERTA CORREDERA SLIDING DOOR SYSTEM

ADINOR

OPCIONES DE INSTALACIÓN PUERTA SIMPLE SINGLE DOOR INSTALLATION OPTIONS

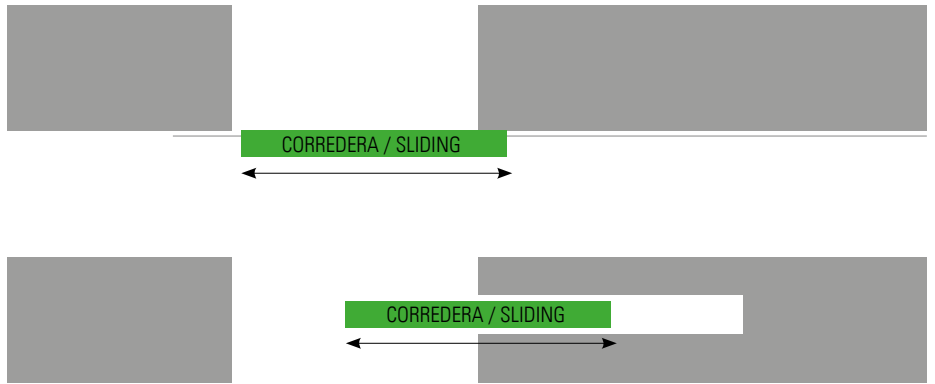

OPCIONES DE INSTALACIÓN PUERTA DOBLE DOUBLE DOOR INSTALLATION OPTIONS

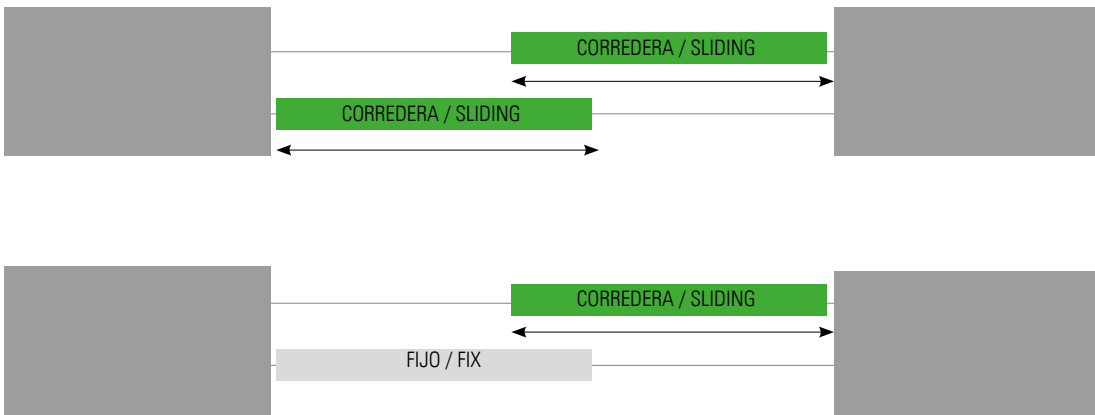

OPCIONES DE INSTALACIÓN 3 PUERTAS 3 DOORS INSTALLATION OPTIONS

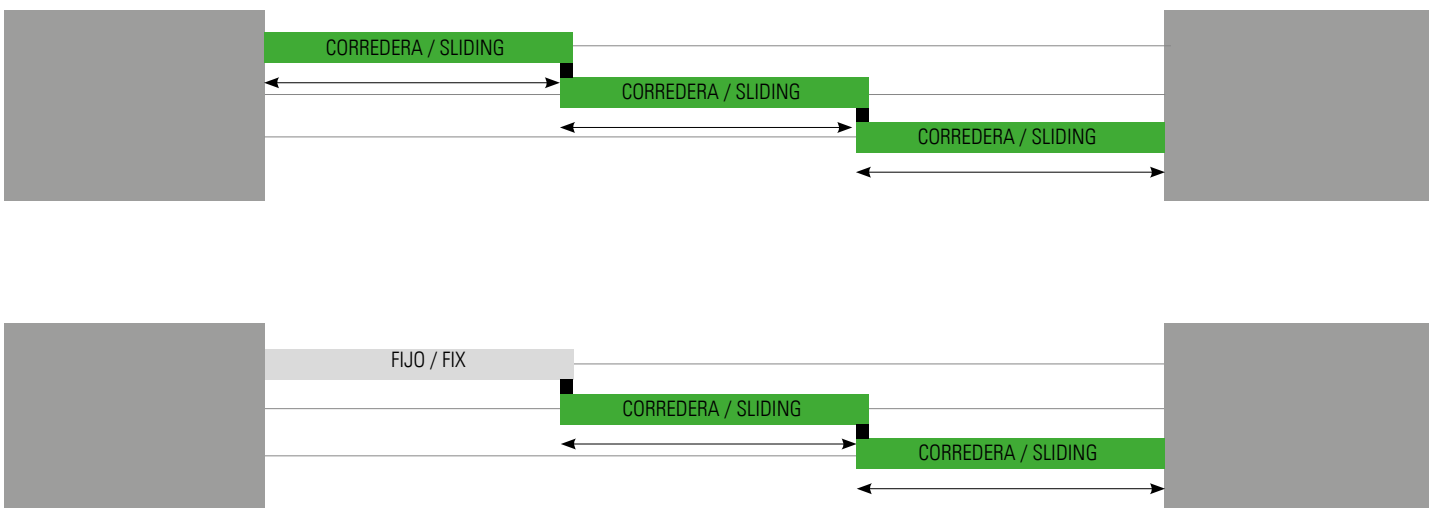

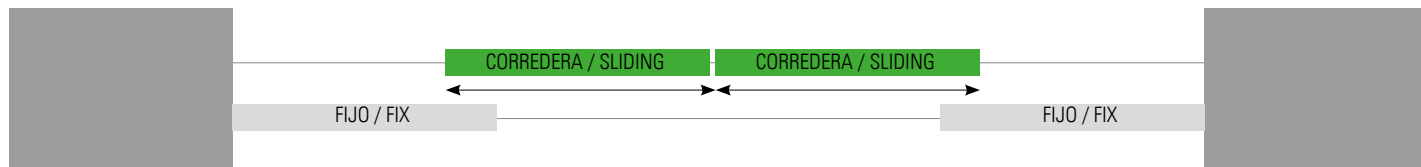
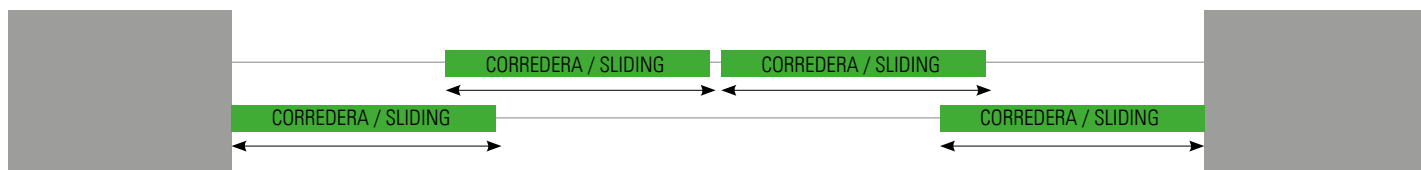

KIT PUERTA ALUMINIO CORREDERA

ALUMINIUM SLIDING DOOR SET

ACABADOS DISPONIBLES

FINISHINGS



Blanco Mate RAL 9003
Mat White RAL 9003



Negro Mate
Mat Black



Moka
Moka



Plata Mate
Natural Anodized



Roble Natural
Oak (Natural Venner)

ACABADOS	FINISHINGS	REF.
LACADOS	COATED	REF.
Blanco Mate RAL9003	RAL 9003 White Mat	PA.L.BM03
Negro Mate	Mat Black	PA.L.NM
Moka	Moka	PA.L.MK
ANODIZADOS	ANODIZED	REF.
Plata Mate	Natural Anodized	PA.A.PM
MADERA	NATURAL WOOD	REF.
Roble Natural	Oak	PA.C.RB

ELEMENTOS DEL KIT

SET ELEMENTS

Perfil vertical
Vertical profile
2 x 2,7m

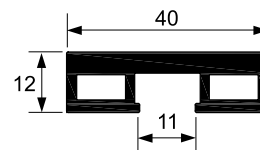

Perfil horizontal
Horizontal profile
2 x 1,5m

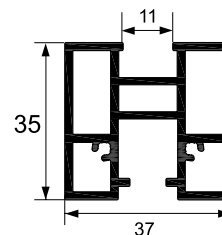

Perfil reductor para vidrio 8mm
8mm transparent gasket
2 x 2,7m
2 x 1,5m

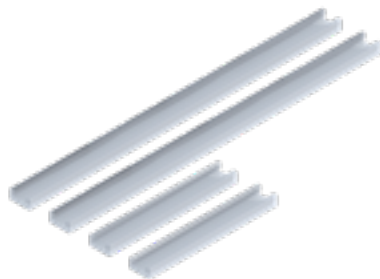

Perfil reductor para vidrio 6mm
6mm transparent gasket
2 x 2,7m
2 x 1,5m

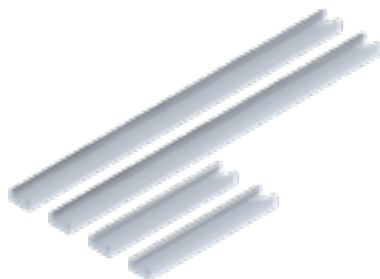

Tornillos
Screws
x 8



Retrac aluminio
Aluminium retrac
x 2



Plantilla
Template
x 1



Brocas
Drills



UTILIZAR LOS CARROS PARA MADERA DE ADINOR
PUERTA DE ALUMINIO COMPATIBLE CON CUALQUIER
CARRO DEL MERCADO

USE ADINOR'S WOOD ROLLERS
ALUMINIUM FRAME DOOR ALSO VALID WITH
ANY ROLLER SYSTEM ON THE MARKET

KIT DIVISOR HORIZONTAL

HORIZONTAL PARTITION SET



Blanco Mate RAL 9003
Mat White RAL 9003



Negro Mate
Mat Black



Moka
Moka



Plata Mate
Natural Anodized



Roble Natural
Oak (Natural Venner)

ACABADOS

FINISHINGS

LACADOS	COATED	REF.
Blanco Mate RAL9003	Mat White RAL 9003	PAH.L.BM03
Negro Mate	Mat Black	PAH.L.NM
Moka	Moka	PAH.L.MK
ANODIZADOS	ANODIZED	REF.
Plata Mate	Natural Anodized	PAH.A.PM
MADERA	LAMINATED WOOD	REF.
Roble Natural	Oak	PAH.C.RB

ELEMENTOS DEL KIT

SET ELEMENTS

Perfil H horizontal
Horizontal H profile
1,5m

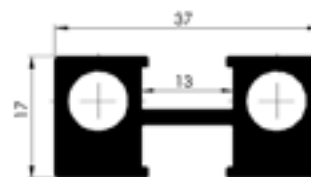

Perfil reductor para vidrio 6mm
6mm transparent gasket
2 x 1,5m



Perfil reductor para vidrio 8mm
8mm transparent gasket
2 x 1,5m



Elementos de unión x4
Joint elements



Brocas
Drills



Plantilla
Template



EMBELLECEDOR AUTOADHESIVO HORIZONTAL - VERTICAL

SELF-ADHESIVE HORIZONTAL AND VERTICAL TRIM



Blanco Mate RAL 9003
Mat White RAL 9003



Negro Mate
Mat Black



Moka
Moka



Plata Mate
Natural Anodized

ACABADOS

FINISHINGS

LACADOS	COATED	REF.
Blanco Mate RAL9003	Mat White RAL 9003	PAEVH.L.BM03
Negro Mate	Mat Black	PAEVH.L.NM
Moka	Moka	PAEVH.L.MK
ANODIZADOS	ANODIZED	REF.
Plata Mate	Natural Anodized	PAEVH.A.PM



Perfil Autoadhesivo 2,8m
2,8m Self-adhesive profile

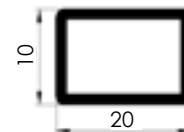

CERRADURA PICO DE LORO CON EMBELLECEDORES Y TIRADOR INCORPORADO

SLIDING DOOR LOCK + END COVERS + HANDLE

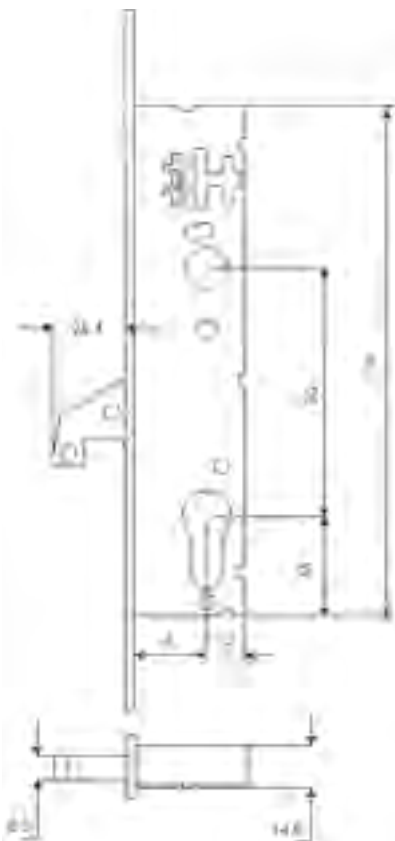

ACABADOS	FINISHINGS	DESCRIPCION / DESCRIPTION	REF.
Blanco Mate RAL9003	Mat White RAL9003	Cilindro / Cylinder	PA.CPL.L.BM03
Negro Mate	Mat Black	Cilindro / Cylinder	PA.CPL.L.NM
Moka	Moka	Cilindro / Cylinder	PA.CPL.L.MK
Plata Mate	Natural Anodized	Cilindro / Cylinder	PA.CPL.A.PM

CERRADERO (para cerradura pico loro)

STRIKE PLATE (for sliding door lock)

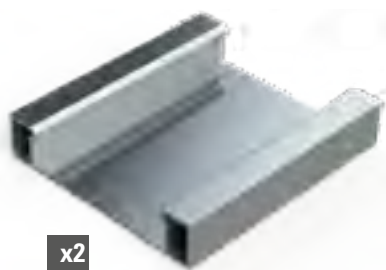

x2

Longitud / Length : 2,8 m.

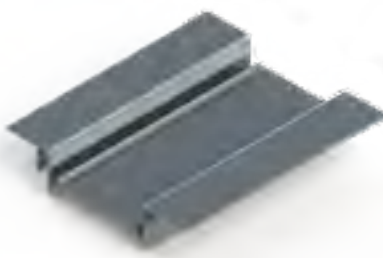

Longitud / Length : 2,8 m.

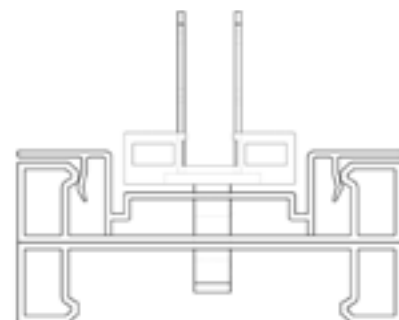
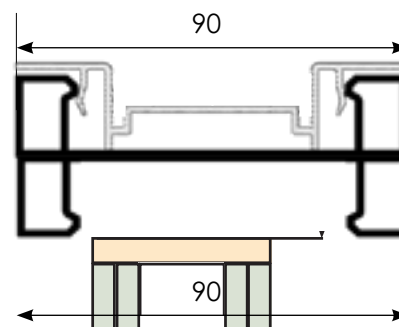

ACABADOS	FINISHINGS	REF.
LACADOS	COATED	REF.
Blanco Mate RAL9003	Mat White RAL 9003	PA.CER.L.BM03
Negro Mate	Mat Black	PA.CER.L.NM
Moka	Moka	PA.CER.L.MK
ANODIZADOS	ANODIZED	REF.
Plata Mate	Natural Anodized	PA.CER.A.PM

TIRADOR CAVE

CAVE ALUMINIUM HANDLE

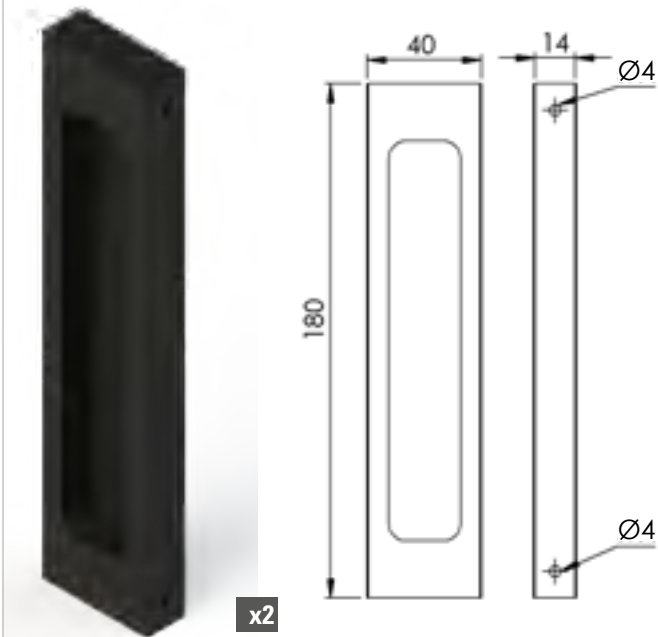

ACABADOS	FINISHINGS	REF.
LACADOS	COATED	REF.
Blanco Mate RAL9003	Mat White RAL 9003	PA.TC.L.BM03
Negro Mate	Mat Black	PA.TC.L.NM
Moka	Moka	PA.TC.L.MK
Plata Mate	Natural Anodized	PA.TC.A.PM

TIRADOR HOLE

HOLE ALUMINIUM HANDLE

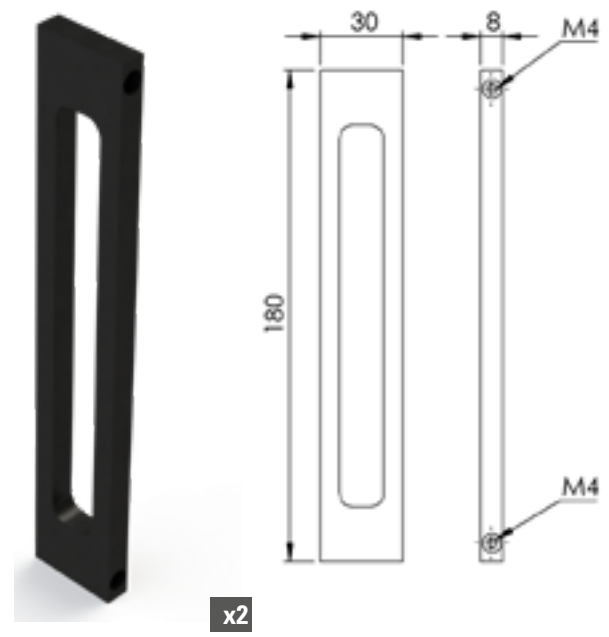

ACABADOS	FINISHINGS	REF.
LACADOS	COATED	REF.
Blanco Mate RAL9003	Mat White RAL 9003	PA.TH.L.BM03
Negro Mate	Mat Black	PA.TH.L.NM
Moka	Moka	PA.TH.L.MK
Plata Mate	Natural Anodized	PA.TH.A.PM

TIRADOR CAVE AUTOADHESIVO

CAVE ALUMINIUM SELF-ADHESIVE HANDLE

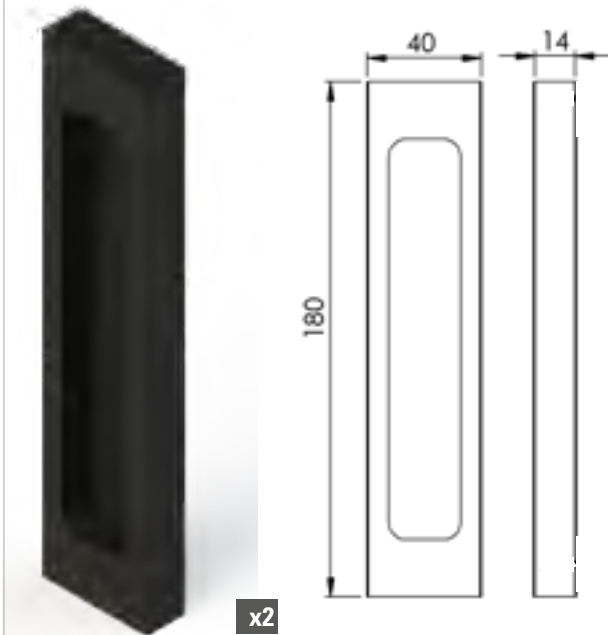

ACABADOS	FINISHINGS	REF.
LACADOS	COATED	REF.
Blanco Mate RAL9003	Mat White RAL 9003	PA.TCA.L.BM03
Negro Mate	Mat Black	PA.TCA.L.NM
Moka	Moka	PA.TCA.L.MK
Plata Mate	Natural Anodized	PA.TCA.A.PM

TIRADOR 30x180 mm

30x180 mm ALUMINIUM HANDLE

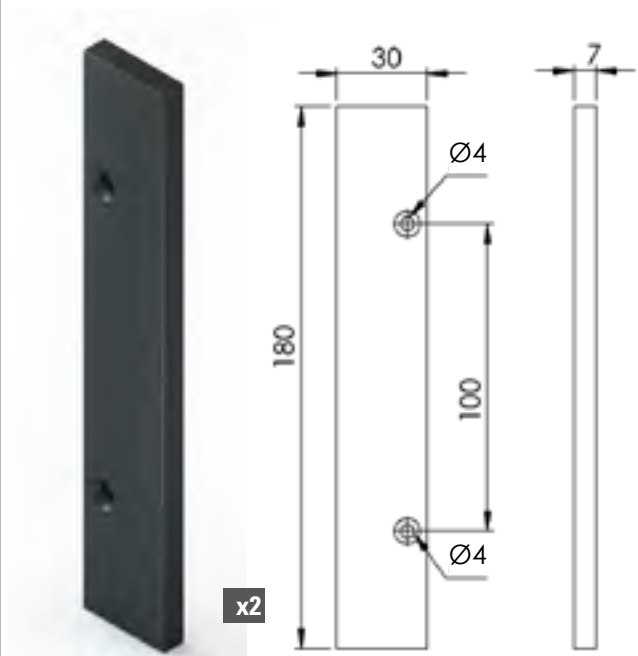

ACABADOS	FINISHINGS	REF.
LACADOS	COATED	REF.
Blanco Mate RAL9003	Mat White RAL 9003	PA.TR.L.BM03
Negro Mate	Mat Black	PA.TR.L.NM
Moka	Moka	PA.TR.L.MK
Plata Mate	Natural Anodized	PA.TR.A.PM

TIRADOR ADHESIVO RECTANGULAR

SELF ADHESIVE RECTANGULAR HANDLE

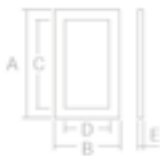

x2



x2



REF.	A (mm)	B (mm)	C (mm)	D (mm)	E (mm)
PA.1261464	85	50	65	20	6
PA.4561464	150	60	130	20	6
PA.5661464	300	75	280	20	6
PA.6761464	500	90	480	20	6

TIRADOR ADHESIVO OLAS

SELF ADHESIVE OLAS HANDLE

Incluye adhesivo 3M
3M glue included

x2



x2



REF.	mm
PA.1827514	75 x 75 x 6
PA.2927514	150 x 75 x 6

TIRADOR ADHESIVO CIRCULAR

SELF ADHESIVE CIRCULAR HANDLE



x2



REF.	A (mm)	B (mm)	E (mm)
PA.861464	30	70	6

GUIADOR PA

PA BOTTOM GUIDER

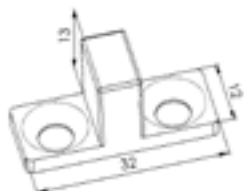

REF.

PA.750

GUIADOR FIJO

FIX BOTTOM GUIDER

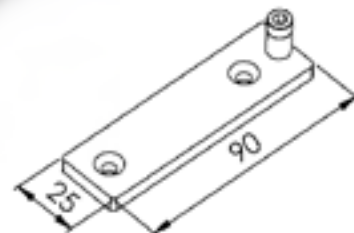

ACABADOS

FINISHINGS

LACADOS	COATED	REF.
Blanco Mate RAL9003	Mat White RAL 9003	PA.G.L.BM03
Negro Mate	Mat Black	PA.G.L.NM
Moka	Moka	PA.G.L.MK
Plata Mate	Natural Anodized	PA.G.A.PM

ARRASTRE DE PUERTA IZQUIERDO

LEFT PULL DOOR

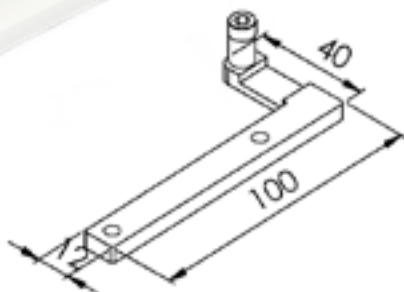

ACABADOS

FINISHINGS

LACADOS	COATED	REF.
Blanco Mate RAL9003	Mat White RAL 9003	PA.AI.L.BM03
Negro Mate	Mat Black	PA.AI.L.NM
Moka	Moka	PA.AI.L.MK
Plata Mate	Natural Anodized	PA.AI.A.PM

ARRASTRE DE PUERTA DERECHO

RIGHT PULL DOOR

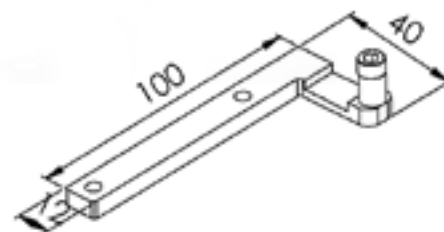

ACABADOS

FINISHINGS

LACADOS	COATED	REF.
Blanco Mate RAL9003	Mat White RAL 9003	PA.AD.L.BM03
Negro Mate	Mat Black	PA.AD.L.NM
Moka	Moka	PA.AD.L.MK
Plata Mate	Natural Anodized	PA.AD.A.PM

30X30 SISTEMA ABATIBLE Y FIJO

30X30 ALUMINIUM SYSTEM







SISTEMA ABATIBLE Y FIJO 30x30 30X30 ALUMINIUM SYSTEM ADINOR

POSIBILIDADES DE MONTAJE ASSEMBLY OPTIONS

Sistema de aluminio con perfileira cuadrangular de 30mm que nos permite fabricar tanto divisores fijos como puertas abatibles y correderas. El sistema permite realizar tanto divisiones verticales como horizontales y utilizar cualquier tipo de vidrio de espesor entre 6 y 8mm.

Aluminum system with 30mm quadrangular profile that allows us to manufacture fixed dividers, folding and sliding doors. The system allows to make both vertical and horizontal divisions and use any kind of glass thickness between 6 and 8mm.

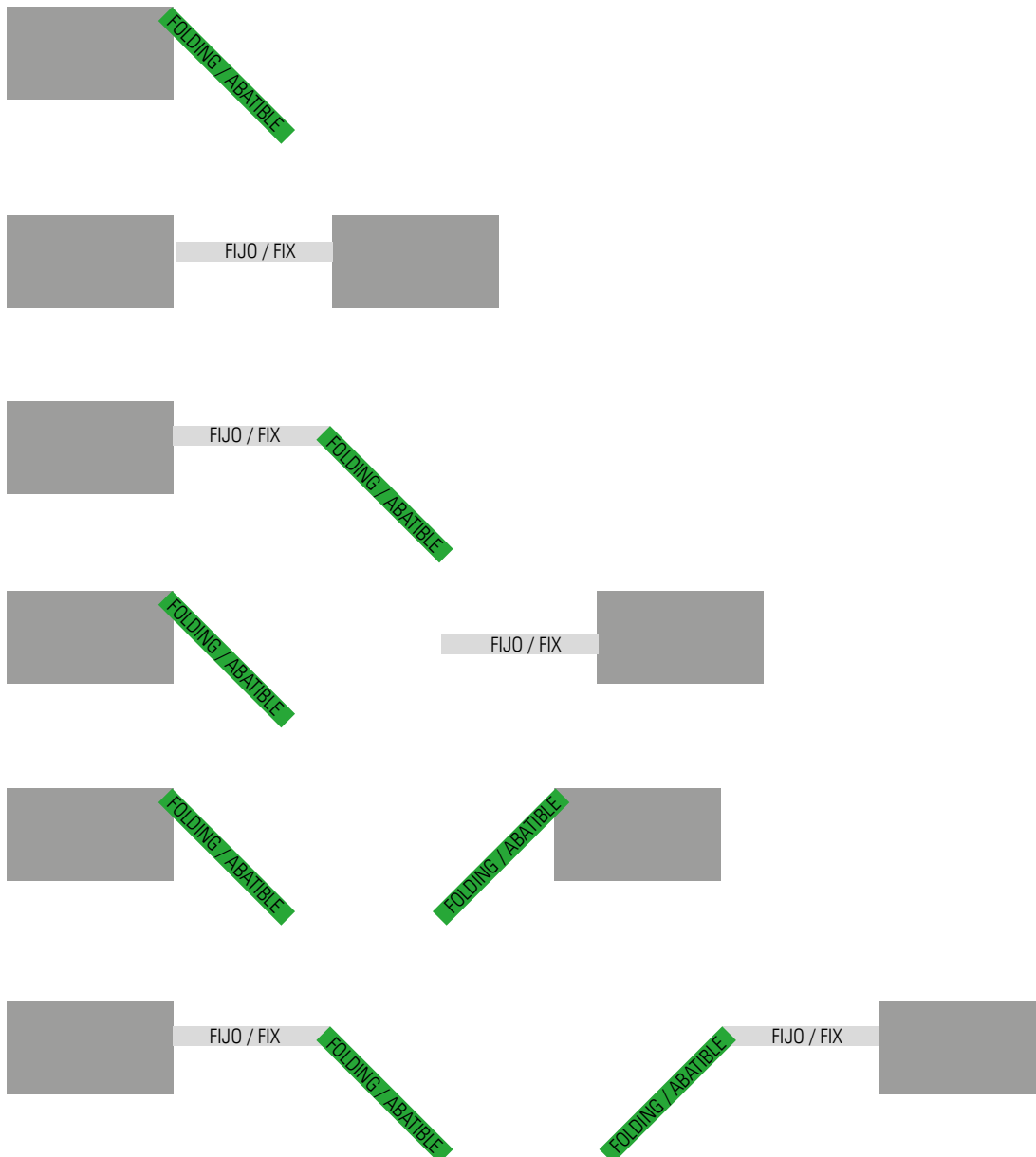

OPCION DE PUERTAS

OPTIONS

ACABADOS DISPONIBLES

FINISHINGS



Blanco Mate RAL 9003
Mat White RAL 9003



Negro Mate
Mat Black



RAL
RAL Coated

PUERTA SIMPLE

SIMPLE DOOR

MOD.A

PUERTA CON DIVISION HORIZONTAL

HORIZONTAL PARTITION DOOR

MOD.B

PUERTA CON DIVISION VERTICAL

VERTICAL PARTITION DOOR

MOD.C

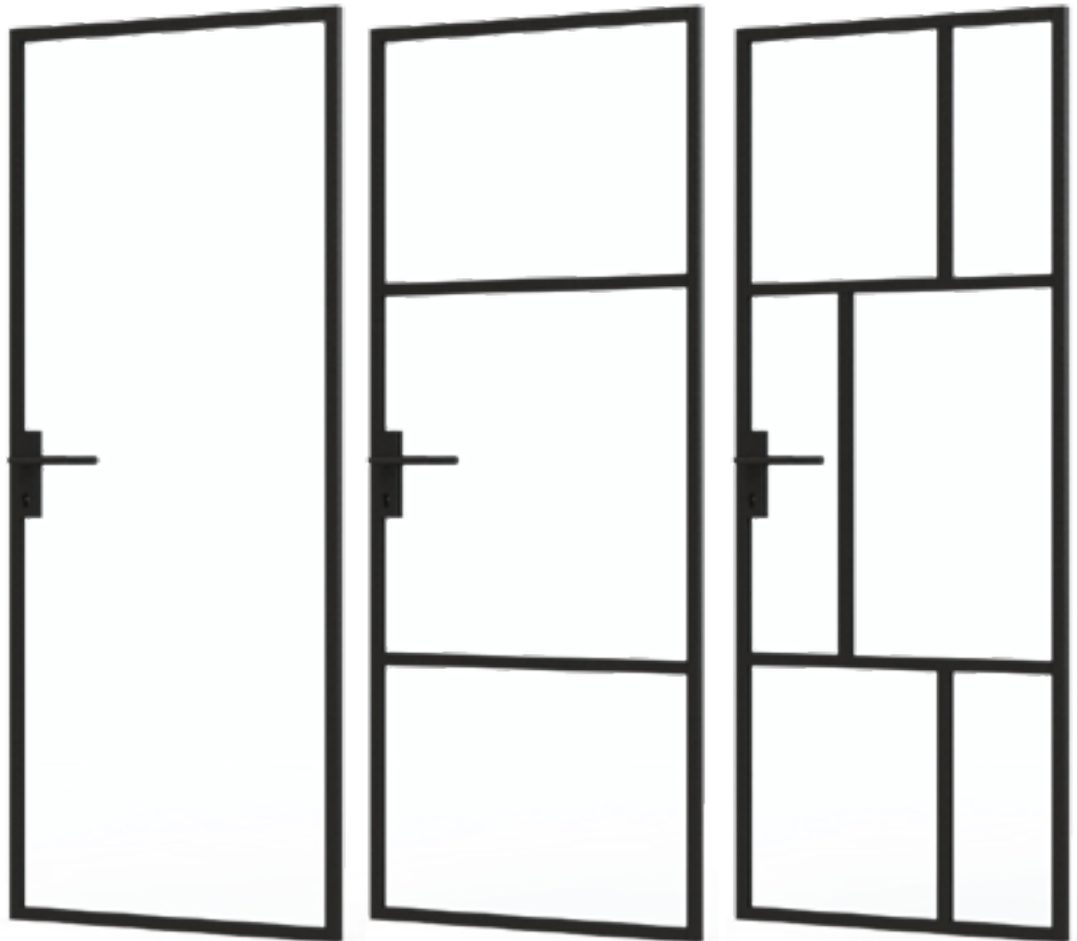

ACABADOS	FINISHINGS	ALTURA HASTA 2100mm			ALTURA HASTA 2500mm			ALTURA HASTA 3000mm		
LACADOS	COATED	MOD.A	MOD.B	MOD.C	MOD.A	MOD.B	MOD.C	MOD.A	MOD.B	MOD.C
Blanco Mate RAL9003	Mat White RAL 9003	PA3S.211.L.B	PA3H.211.L.B	PA3HV.211.L.B	PA3S.250.L.B	PA3H.250.L.B	PA3HV.250.L.B	PA3S.300.L.B	PA3H.300.L.B	PA3VH.300.L.B
Negro Mate	Mat Black	PA3S.211.L.NM	PA3H.211.L.NM	PA3HV.211.L.NM	PA3S.250.L.NM	PA3H.250.L.NM	PA3HV.250.L.NM	PA3S.300.L.NM	PA3H.300.L.NM	PA3VH.300.L.NM
RAL	RAL Coated	PA3S.211.L.R	PA3H.211.L.R	PA3HV.211.L.R	PA3S.250.L.R	PA3H.250.L.R	PA3HV.250.L.R	PA3S.300.L.R	PA3H.300.L.R	PA3VH.300.L.R

*Anchura puerta: 925mm. Resto medidas consultar / Door width:925mm. Other measures under request

FIJO SIMPLE
SIMPLE PANNEL
MOD.A

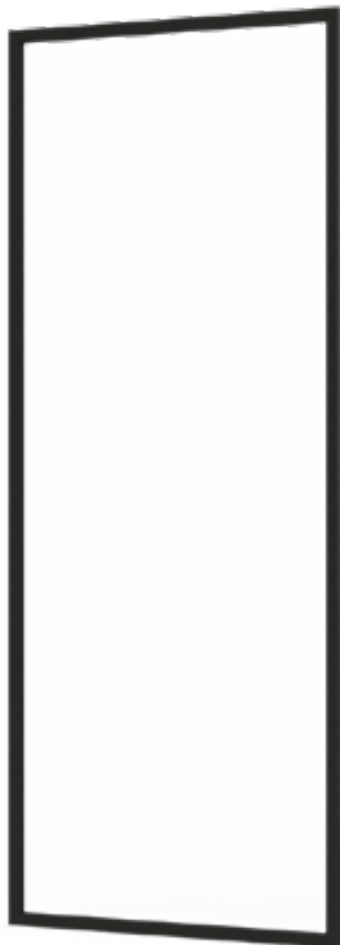

FIJO CON DIVISION HORIZONTAL
HORIZONTAL PARTITION PANNEL
MOD.B



FIJO CON DIVISION VERTICAL
VERTICAL PARTITION PANNEL
MOD.C



		ALTURA HASTA 2110mm								
		ANCHO HASTA 1000mm WIDTH UP TO 1000mm			ANCHO HASTA 1500mm WIDTH UP TO 1500mm			ANCHO HASTA 2000mm WIDTH UP TO 2000mm		
LACADOS	COATED	MOD.A	MOD.B	MOD.C	MOD.A	MOD.B	MOD.C	MOD.A	MOD.B	MOD.C
Blanco Mate RAL9003	Mat White RAL 9003	PAFS.21.1.L.B	PAFH.21.1.L.B	PAFHV.21.1.L.B	PAFS.21.15.L.B	PAFH.21.15.L.B	PAFHV.21.15.L.B	PAFS.21.20.L.B	PAFH.21.20.L.B	PAFHV.21.20.L.B
Negro Mate	Mat Black	PAFS.21.1.L.N	PAFH.21.1.L.N	PAFHV.21.1.L.N	PAFS.21.15.L.N	PAFH.21.15.L.N	PAFHV.21.15.L.N	PAFS.21.20.L.N	PAFH.21.20.L.N	PAFHV.21.20.L.N
RAL	RAL Coated	PAFS.21.1.L.R	PAFH.21.1.L.R	PAFHV.21.1.L.R	PAFS.21.15.L.R	PAFH.21.15.L.R	PAFHV.21.15.L.R	PAFS.21.20.L.R	PAFH.21.20.L.R	PAFHV.21.20.L.R

		ALTURA HASTA 2500mm								
		ANCHO HASTA 1000mm WIDTH UP TO 1000mm			ANCHO HASTA 1500mm WIDTH UP TO 1500mm			ANCHO HASTA 2000mm WIDTH UP TO 2000mm		
LACADOS	COATED	MOD.A	MOD.B	MOD.C	MOD.A	MOD.B	MOD.C	MOD.A	MOD.B	MOD.C
Blanco Mate RAL9003	Mat White RAL 9003	PAFS.25.1.L.B	PAFH.25.1.L.B	PAFHV.25.1.L.B	PAFS.25.15.L.B	PAFH.25.15.L.B	PAFHV.25.15.L.B	PAFS.25.20.L.B	PAFH.25.20.L.B	PAFHV.25.20.L.B
Negro Mate	Mat Black	PAFS.25.1.L.N	PAFH.25.1.L.N	PAFHV.25.1.L.N	PAFS.25.15.L.N	PAFH.25.15.L.N	PAFHV.25.15.L.N	PAFS.25.20.L.N	PAFH.25.20.L.N	PAFHV.25.20.L.N
RAL	RAL Coated	PAFS.25.1.L.R	PAFH.25.1.L.R	PAFHV.25.1.L.R	PAFS.25.15.L.R	PAFH.25.15.L.R	PAFHV.25.15.L.R	PAFS.25.20.L.R	PAFH.25.20.L.R	PAFHV.25.20.L.R

		ALTURA HASTA 3000mm								
		ANCHO HASTA 1000mm WIDTH UP TO 1000mm			ANCHO HASTA 1500mm WIDTH UP TO 1500mm			ANCHO HASTA 2000mm WIDTH UP TO 2000mm		
LACADOS	COATED	MOD.A	MOD.B	MOD.C	MOD.A	MOD.B	MOD.C	MOD.A	MOD.B	MOD.C
Blanco Mate RAL9003	Mat White RAL 9003	PAFS.30.1.L.B	PAFH.30.1.L.B	PAFHV.30.1.L.B	PAFS.30.15.L.B	PAFH.30.15.L.B	PAFHV.30.15.L.B	PAFS.30.20.L.B	PAFH.30.20.L.B	PAFHV.30.20.L.B
Negro Mate	Mat Black	PAFS.30.1.L.N	PAFH.30.1.L.N	PAFHV.30.1.L.N	PAFS.30.15.L.N	PAFH.30.15.L.N	PAFHV.30.15.L.N	PAFS.30.20.L.N	PAFH.30.20.L.N	PAFHV.30.20.L.N
RAL	RAL Coated	PAFS.30.1.L.R	PAFH.30.1.L.R	PAFHV.30.1.L.R	PAFS.30.15.L.R	PAFH.30.15.L.R	PAFHV.30.15.L.R	PAFS.30.20.L.R	PAFH.30.20.L.R	PAFHV.30.20.L.R

CIERRE MAGNETICO

MAGNETIC CLOSING

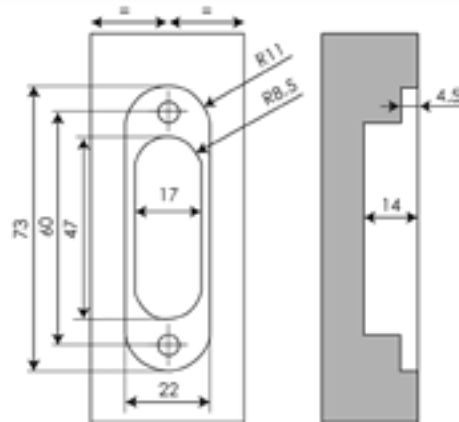

REF.

PA.250

CERRADURA + EMBELLECEDOR

LOCK + COVERS

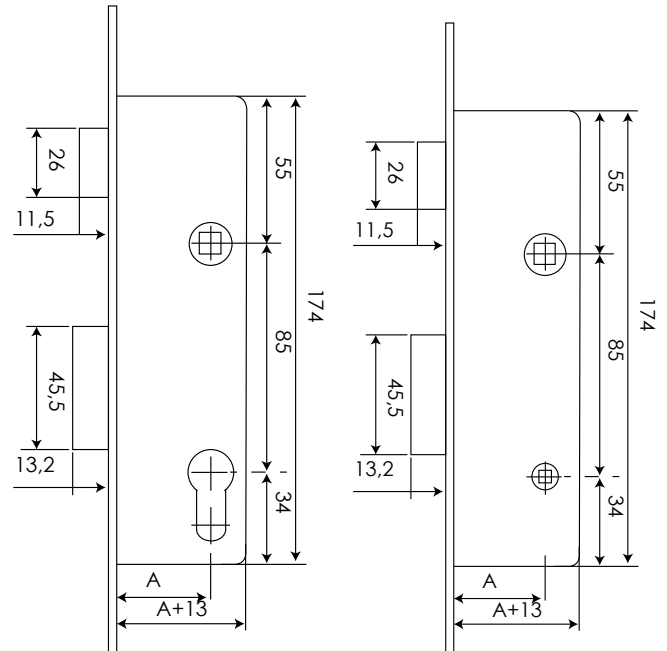

ACABADOS	FINISHINGS	DESCRIPCION / DESCRIPTION	REF.
Negro Mate	Mat Black	Con cilindro / With cylinder	PAP3.CC.L.NM
		Sin cilindro / Without cylinder	PAP3.CSC.L.NM
		Con condena / With WC lock	PAP3.CWC.L.NM
Blanco Mate Ral 9003	Mat White RAL9003	Con cilindro / With cylinder	PAP3.CC.L.BM03
		Sin cilindro / Without cylinder	PAP3.CSC.L.BM03
		Con condena / With WC lock	PAP3.CWC.L.BM03
Lacado Ral	RAL Coated	Con cilindro / With cylinder	PAP3.CC.L.RAL
		Sin cilindro / Without cylinder	PAP3.CSC.L.RAL
		Con condena / With WC lock	PAP3.CWC.L.RAL

MANETA AMSTERDAM

AMSTERDAM HANDLE

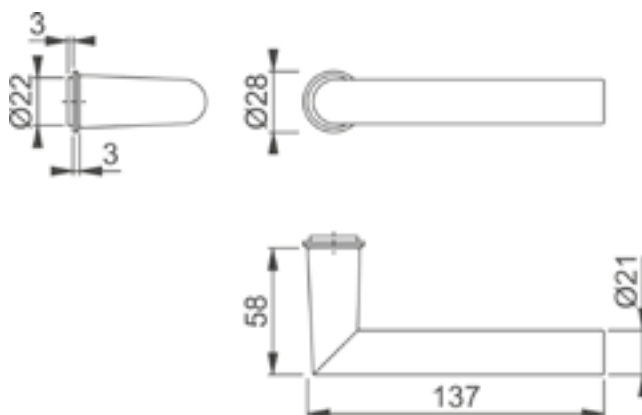

ACABADOS	FINISHINGS	REF.
Blanco	White	PAP.MA.L.B
Negro	Black	PAP.MA.L.N

MANETA TOULON

TOULON HANDLE

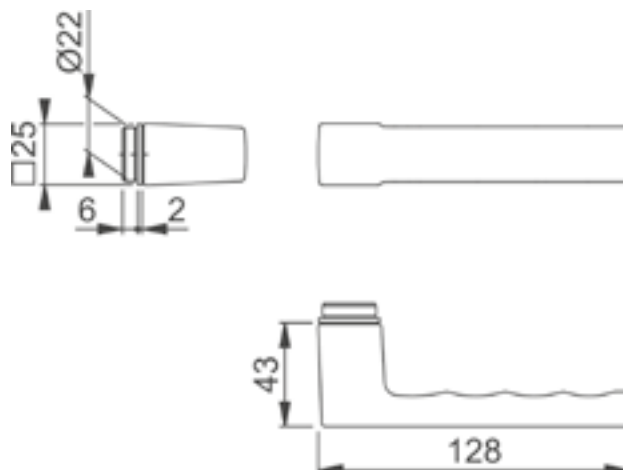

ACABADOS	FINISHINGS	REF.
Blanco	White	PAP.MT.L.B
Negro	Black	PAP.MT.L.N

BISAGRA OCULTA BB

CONCEALED HINGE

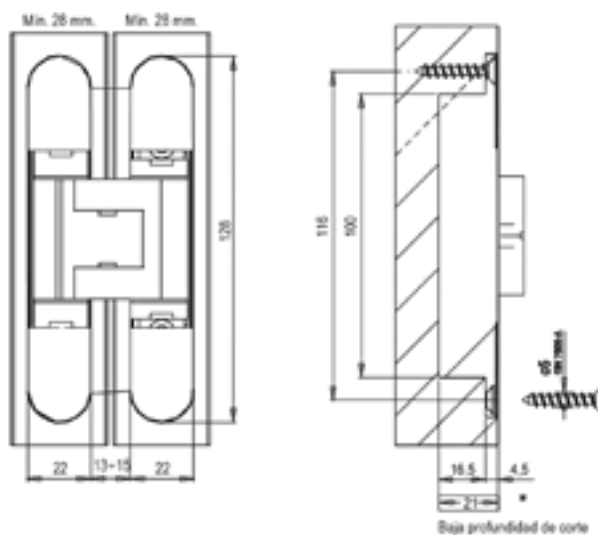

ACABADOS	REF.
Negro	MR.BB.N
Blanco	MR.BB.B
Cromo Satinado	MR.BB.CS

PERFIL 30x30 1SALIDA

30x30 1 SLOT ALUMINIUM PROFILE

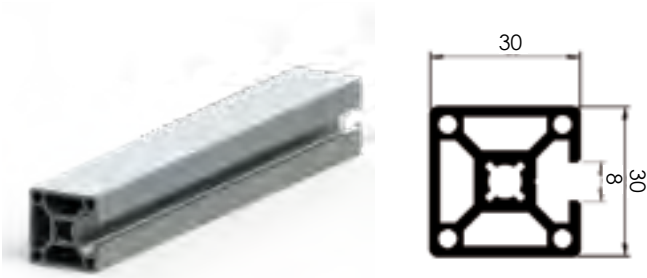

ACABADOS	FINISHINGS	REF.
LACADOS	COATED	
Blanco Mate RAL9003	Mat White RAL 9003	5027.L.BM03
Negro Mate	Mat Black	5027.L.NM
Ral	RAL	5027.L.RAL

PERFIL 30x30 180° 2 SALIDAS

30x30 180° 2 SLOTS ALUMINIUM PROFILE

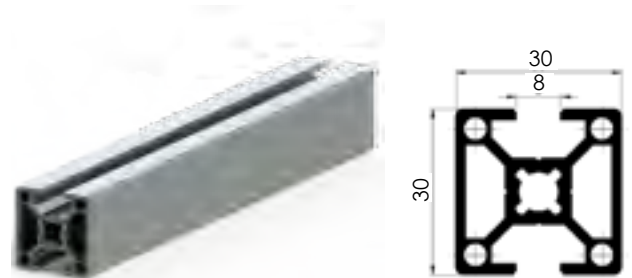

ACABADOS	FINISHINGS	REF.
LACADOS	COATED	
Blanco Mate RAL9003	Mat White RAL 9003	5025.L.BM03
Negro Mate	Mat Black	5025.L.NM
Ral	RAL	5025.L.RAL

PERFIL 30x30 90° 2 SALIDAS

30x30 90° 2 SLOTS ALUMINIUM PROFILE

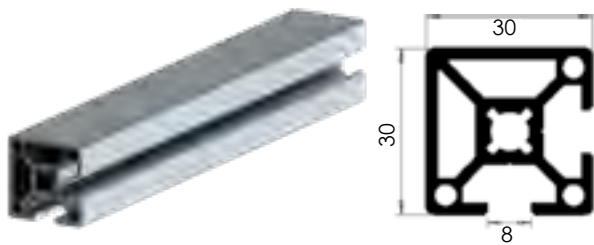

ACABADOS	FINISHINGS	REF.
LACADOS	COATED	
Blanco Mate RAL9003	Mat White RAL 9003	5028.L.BM03
Negro Mate	Mat Black	5028.L.NM
Ral	RAL	5028.L.RAL

PERFIL 30x30 3 SALIDAS

30x30 3 SLOTS ALUMINIUM PROFILE

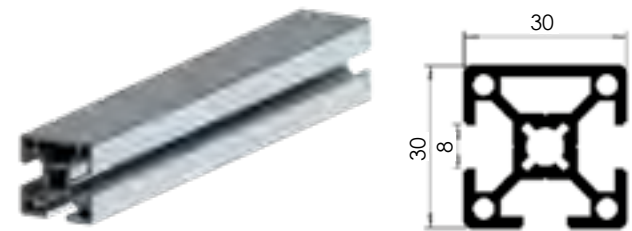

ACABADOS	FINISHINGS	REF.
LACADOS	COATED	
Blanco Mate RAL9003	Mat White RAL 9003	5029.L.BM03
Negro Mate	Mat Black	5029.L.NM
Ral	RAL	5029.L.RAL

CONECTOR CABEZA REDONDA canal 8mm

ROUND HEAD JOINT, 8mm slot



REF.
535230

PERFIL ADHESIVO ANTIVIBRACIÓN 6mm.

6mm. SELF-ADHESIVE SLOT REDUCER PROFILE



REF.
3427

SISTEMA PLEGABLE PIVOTANTE

BIFOLDING PIVOT SYSTEM







SISTEMA PLEGABLE PIVOTANTE

PIVOT BIFOLDING SYSTEM

ADINOR

POSIBILIDADES DE MONTAJE ASSEMBLY OPTIONS



KIT PUERTA ALUMINIO ABATIBLE PIVOTANTE ALUMINIUM PIVOT DOOR SET

ACABADOS DISPONIBLES FINISHINGS



Blanco Mate RAL 9003
Mat White RAL 9003



Negro Mate
Mat Black



Moka
Moka



Plata Mate
Natural Anodized



Roble Natural
Oak (Natural veneer)

ACABADOS

FINISHINGS

LACADOS	COATED	REF.
Blanco Mate RAL9003	Mat White RAL 9003	PAPPV.L.BM03
Negro Mate	Mat Black	PAPPV.L.NM
Moka	Moka	PAPPV.L.MK
ANODIZADOS	ANODIZED	REF.
Plata Mate	Natural Anodized	PAPPV.A.PM
MADERA	NATURAL WOOD	REF.
Roble Natural	Oak	PAPPV.C.RB

PARA COMPLETAR ESTE SYSTEMA SE RECOMIENDA UTILIZAR LAS GUIAS PLUS DEL SYSTEMA SKY Y SUS SISTEMAS DE CIERRE AMORTIGUADO

TO COMPLETE THIS SYSTEMA IT IS RECOMMENDED TO USE THE PLUS TRACKS FROM THE SKY SYSTEMA AND IT'S SOFT CLOSING SYSTEMS

ELEMENTOS DEL KIT SET ELEMENTS

Perfil vertical
Vertical profile
2 x 2,7m

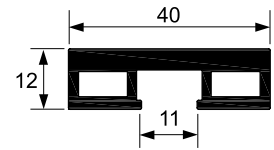

Perfil horizontal
Horizontal profile
2 x 1,5m

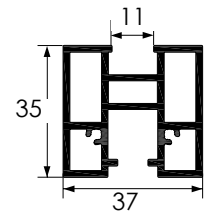

Perfil reductor para vidrio
8mm
8mm transparent gasket
2 x 2,7m
2 x 1,5m

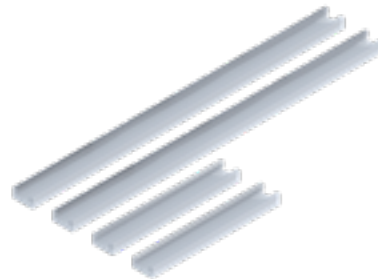

Perfil reductor para vidrio 6mm
6mm transparent gasket
2 x 2,7m
2 x 1,5m

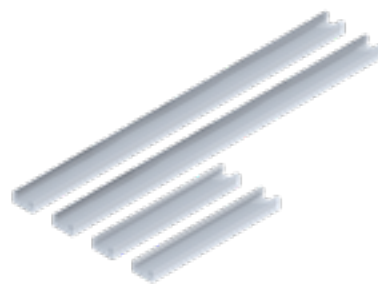

Tornillos
Screws
x 8



Plantilla
Template
x 1



Brocas
Drills



KIT DE HERRAJE PARA PUERTA PLEGABLE PIVOTANTE (2 HOJAS)

HARDWARE SET FOR PIVOT BIFOLD DOOR (2 DOORS)

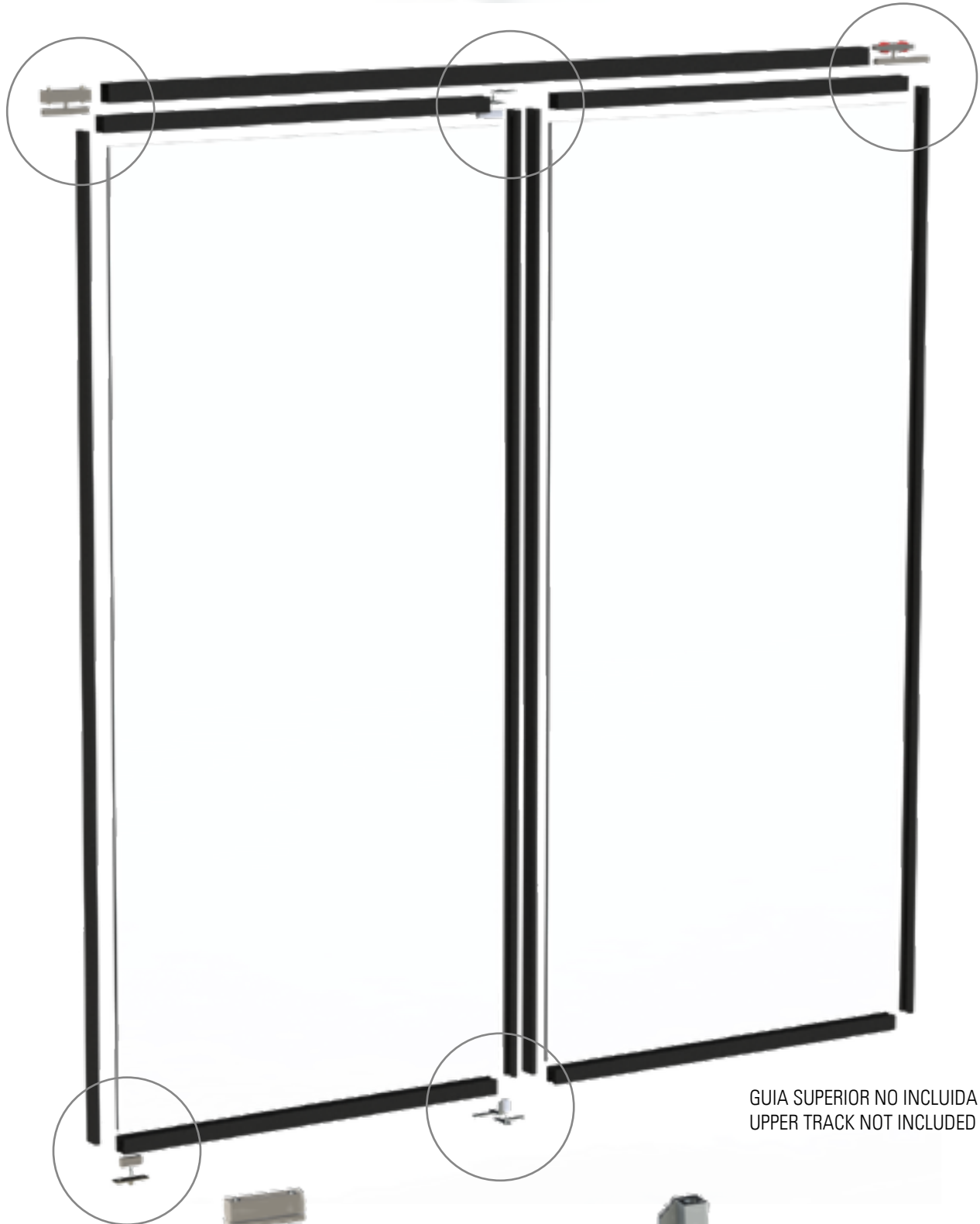

REF.	DESCRIP.
PAPPIV.IZ.500	IZQUIERDA/LEFT
PAPPIV.D.500	DERECHA/RIGHT

KIT DE HERRAJE PARA PUERTA PLEGABLE PIVOTANTE (HOJA EXTRA)

HARDWARE SET FOR PIVOT BIFORLD DOOR (EXTRA DOOR)

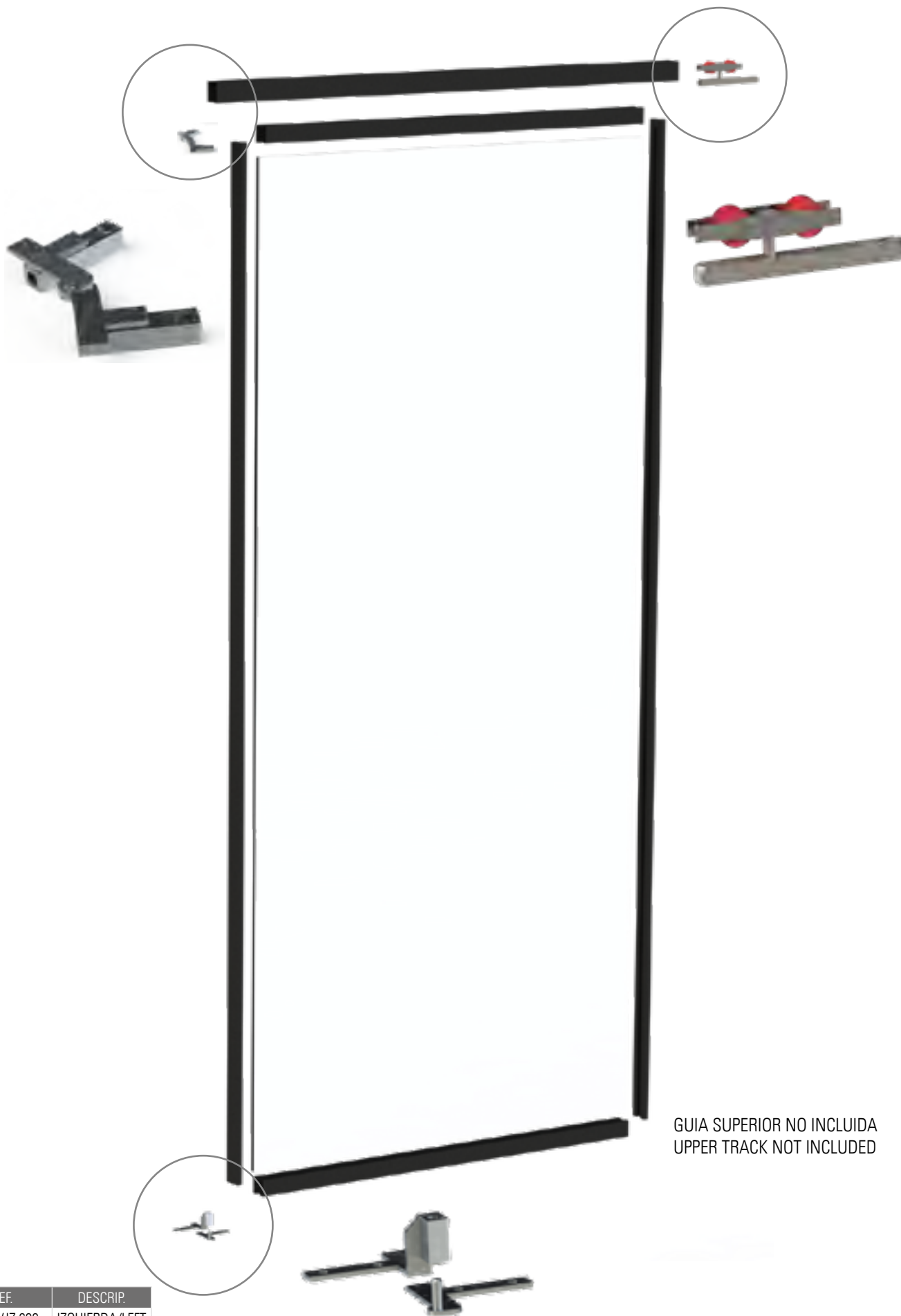

GUIA SUPERIOR NO INCLUIDA
UPPER TRACK NOT INCLUDED

REF.	DESCRIP.
PAPPV.IZ.600	IZQUIERDA/LEFT
PAPPV.D.600	DERECHA/RIGHT

KIT DE HERRAJE PARA PUERTA PLEGABLE PIVOTANTE SIMPLE

HARDWARE SET PIVOT DOOR (BIFOLD SYSTEM)

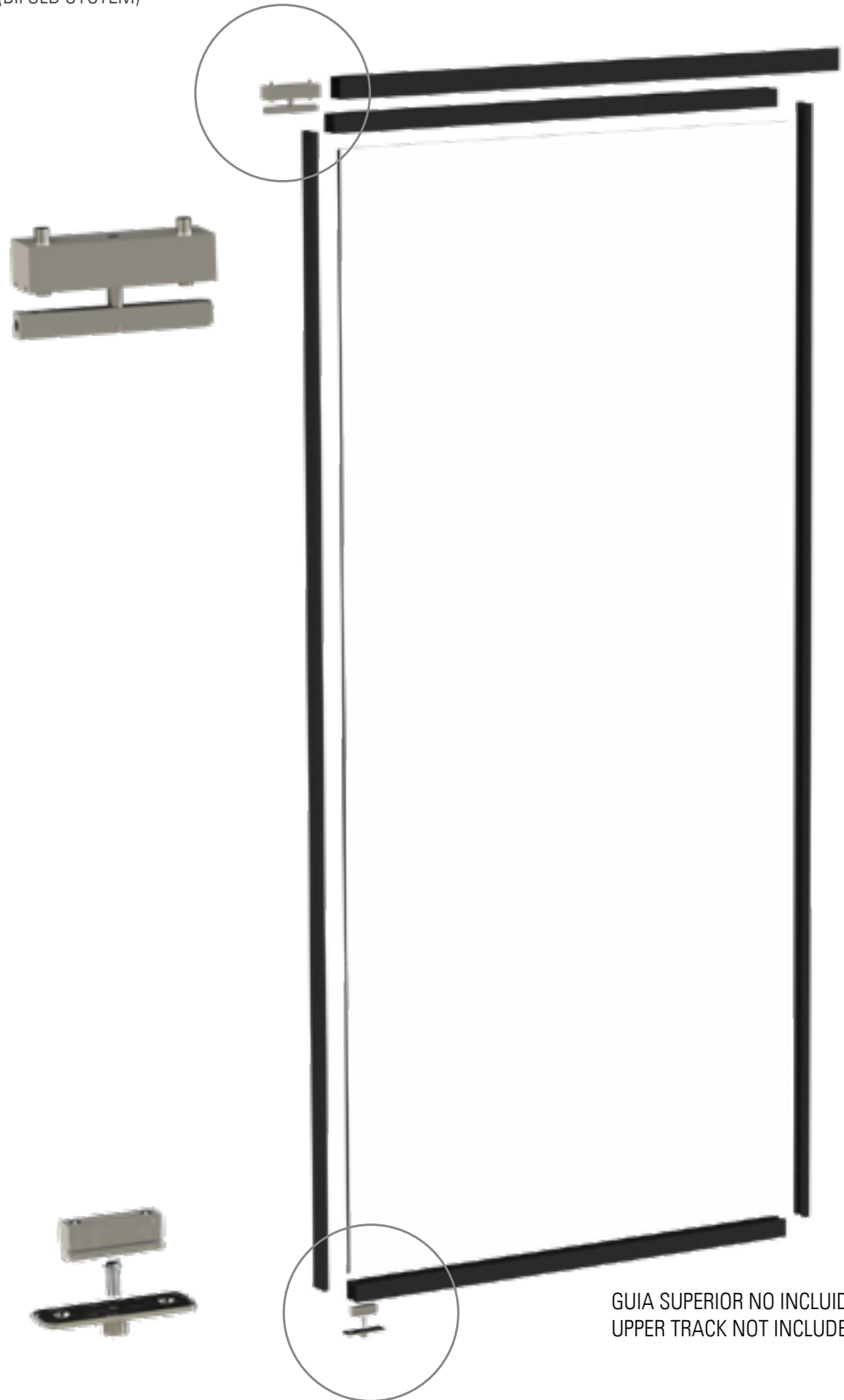

REF.

PAPPIV.700

GUIA SUPERIOR NO INCLUIDA
UPPER TRACK NOT INCLUDED

LACADOS / COATED



Negro Mate
Mat Black



Blanco Brillo
White



Antracita
Anthracite

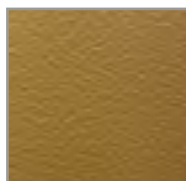

Oro
Gold



Blanco Mate 9010
Mat White 9010



Blanco Mate 9003
Mat White 9003

ANODIZADOS / ANODIZED

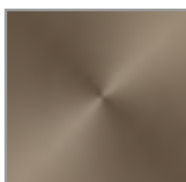

Bronce
Bronze



Plata Mate
Natural Anodized

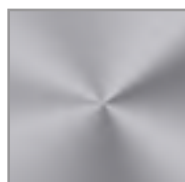

Plata Brillo
Polished Anodized



Inox
Inox

MADERA / NATURAL VENEER



Roble
Oak



Castaño
Chestnut



Haya Vapor
Steam Beech



Pino
Pine



Sapely
Sapely

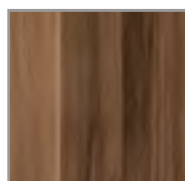

Nogal
Walnut



Haya Blanca
Beech Tree

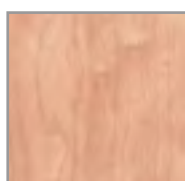

Cerezo
Cherry Tree



Fresno
Ash

VINILOS / VINYL



Blanco Sil

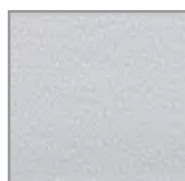

Blanco 9003



Blanco Perla



Halifax Natural



Halifax Tabaco

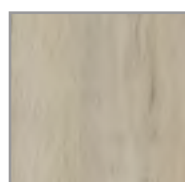

Halifax Blanco



Wengue Duero

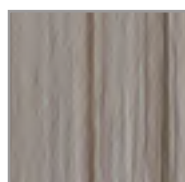

Rosa Palo

Halifax Natural
Halifax Blanco
Halifax Tabaco

EGGER

MELAMINA / MELAMINE



Roble RO 444 / Oak
FINSÁ: Roble RO



Sapely / Sapely D2517
FINSÁ: SAPELY 2



Delicate Birch
FINSÁ:



Haya Vapor 428 / Steam Beech
FINSÁ: Haya L02

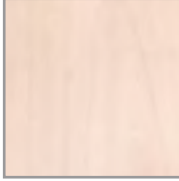

Haya Blanca Almijara Beech Tree
LOSAN: Haya Almijara



Nogal MME
FINSÁ: Nogal MME



Fresno Taiga
FINSÁ: Fresno Taiga



Fresno Glacial
FINSÁ: Fresno Glacial



Roble Espejo super mate
LOSAN: Roble Espejo super mate

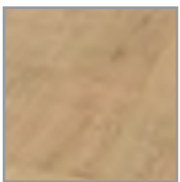

Roble Miel
FINSÁ: Roble Renovables



Sapely Rameado
FINSÁ: Sapely rameado



Nogal Siroko / Walnut
LOSAN: Nogal Siroko



Roble 562 / Oak 562 entablillado
LOSAN: Roble L05

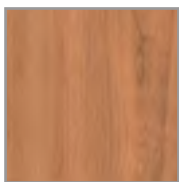

Cerezo Duero / Cherry Tree
LOSAN: Cerezo Duero

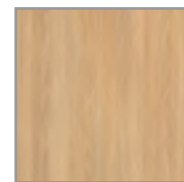

Roble Hera / Oak
LOSAN: Roble Hera



Cerezo Tajo / Cherry Tree
LOSAN: Cerezo Tajo



Wengue Congo / Wengue Congo
LOSAN: Wengue Congo



Textil Capuchino / Capuchino Textil
LOSAN: Textil Capuchino



Blanco Rebornizable White
FINSÁ: Blanco Lacable
LOSAN: Blanco Lacable

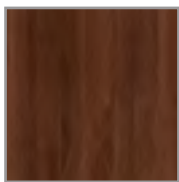

Nogal Montisa / Walnut
LOSAN: Nogal montsia



Roble Natural Q227 / Natural Oak
FINSÁ: Roble Natural



Nogal Canaletto / Walnut
FINSÁ: Nogal Canaletto

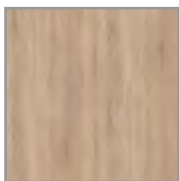

Cambrian / Cambrian Oak
FINSÁ: Cambrian Oak



Roble Precompuesto



Vison Tepee
LOSAN: Vison Tepee

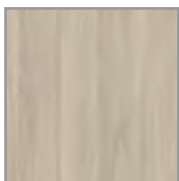

Arce Nacar
LOSAN: Arce Nacar



Roble Carbon / Carbon Oak
LOSAN: Roble Carbon



Textil Coral / Textil Coral
LOSAN: Textil Coral

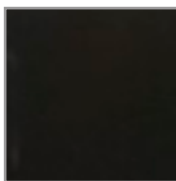

Negro Mate / Mat Black
FINSA: L01



Okumen Blanco /
LOSAN: Okumen Blanco

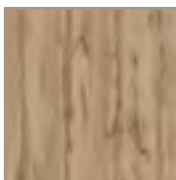

Roble Hercules / Oak
FINSA: Roble Hércules



Roble Sacra
LOSAN: Roble Sacra



Roble Tricio / Oak
FINSA: Roble Tricio



Gris Sarela
LOSAN: Gris Sarela

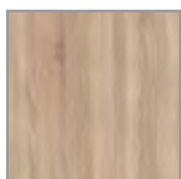

Roble Sonoma Natural
SONAE: Roble Sonoma



Lissa Oak
FINSA: Lissa Oak

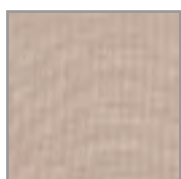

Textil Cancun / Textil Cancun
LOSAN: Textil Cancun
FINSA: Textil Cactus



Castaño Rialto
FINSA: Castaño Rialto

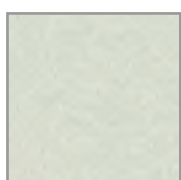

Espiga Sal
FINSA: Espiga Sal

ADINOR

 Av Gijón, 90-92
47009 Valladolid
ESPAÑA

 Tel. (0034) 983 267 512
(0034) 983 255 304

 Fax: (0034) 983 267 508

 pedidos@adinorsl.es
internationalsales@adinorsl.es

 www.adinor.info